

KERN & SOHN GmbH
Balances, Test weights, Microscopes,
DAkkS calibration laboratory
Ziegelei 1
72336 Balingen
Germany

Tel. +49 7433 9933-0
Fax +49 7433 9933-149

info@kern-sohn.com
www.kern-sohn.com

Printed in Germany
by KERN & SOHN GmbH
z-cb-ep-kp-20211

EN



BALANCES & TEST SERVICE

for laboratory, industry and food industry



Readability	Weighting capacity [Max]	Model	Page	Quality code	For an explanation on the pictos, see front page
0,001	60	440-21A	26	AA	
0,001	100	PCB 100-3	25	AA	
0,001	120	PFB 120-3	27	AA	
0,001	120	KB 120-3N	28	AA	
0,001	200	PFB 200-3	27	AA	
0,001	220	EW 220-3NM	33	BB	
0,001	240	KB 240-3N	28	AA	
0,001	240	S72-30	24	AA	
0,001	250	PCB 250-3	25	AA	
0,001	250	PCB 250-3	25	BA	
0,001	300	PFB 300-3	29	BA	
0,001	300	EW 300-3	30	BA	
0,001	300	EW 300-3H	29	BA	
0,001	300	S72-31	24	AA	
0,001	350	PCB 350-3	25	AA	
0,001	340	KB 340-3N	28	BA	
0,001	420	S72-32	31	BA	
0,001	420	PL 420-3F	31	BA	
0,001	420	PL 420-3F	31	AB	
0,001	420	EW 420-3NM	33	BB	
0,001	420	EG 420-3NM	32	BB	
0,001	420	PNS 400-3	32	BB	
0,001	420	PNI 400-3M	33	AB	
0,001	420	EW 420-3NM	33	BB	
0,001	420	EG 420-3NM	34	BC	

How do I quickly find the product I am looking for?

The tried and tested quick search system – “Quick-Finder” ahead of each product group allows you to base the search for a certain target group on weighing data you need such as readout, weighing capacity and main features for each model.

And it's as simple as that – find the product you want in 2 steps:

1. Go to the product group index on page 3
2. Pick the appropriate product group and find the product you want using the Quick-Finder.

... or use the model name and find the product quickly and efficiently using the A-Z model list:

KERN Models A – Z

440	26	FKB-A	55	N	
572	30	FKB	57	NIB	123
		FOB	65	NFB	124
		FOB-LM	66	NFN	125
		FOB-NL	67		
		FOB-NS	64	P	
		FOB-S	63	PBJ/PBS	34
		FXN	70	PCB	25
				PCD	24
				PEJ/PES	35
				PFB	27
				PLJ/PLS	31
				PNJ/PNS	32
				R	
				RIB	74
				RPB	75
				S	
				SFB/SFB-H	71
				SFE	105
				SXS	72
				T	
				TEE	12
				TGC	12
				TGD	13
				U	
				UFA	118
				UFB	121
				UFN	122
				UIB	119
				UID	120
				V	
				VHB	152
				W	
				WTB	68
				Y	
				YKV-01	128
				YRO-01/-02/-03	182

PROFESSIONAL MEASURING

2021

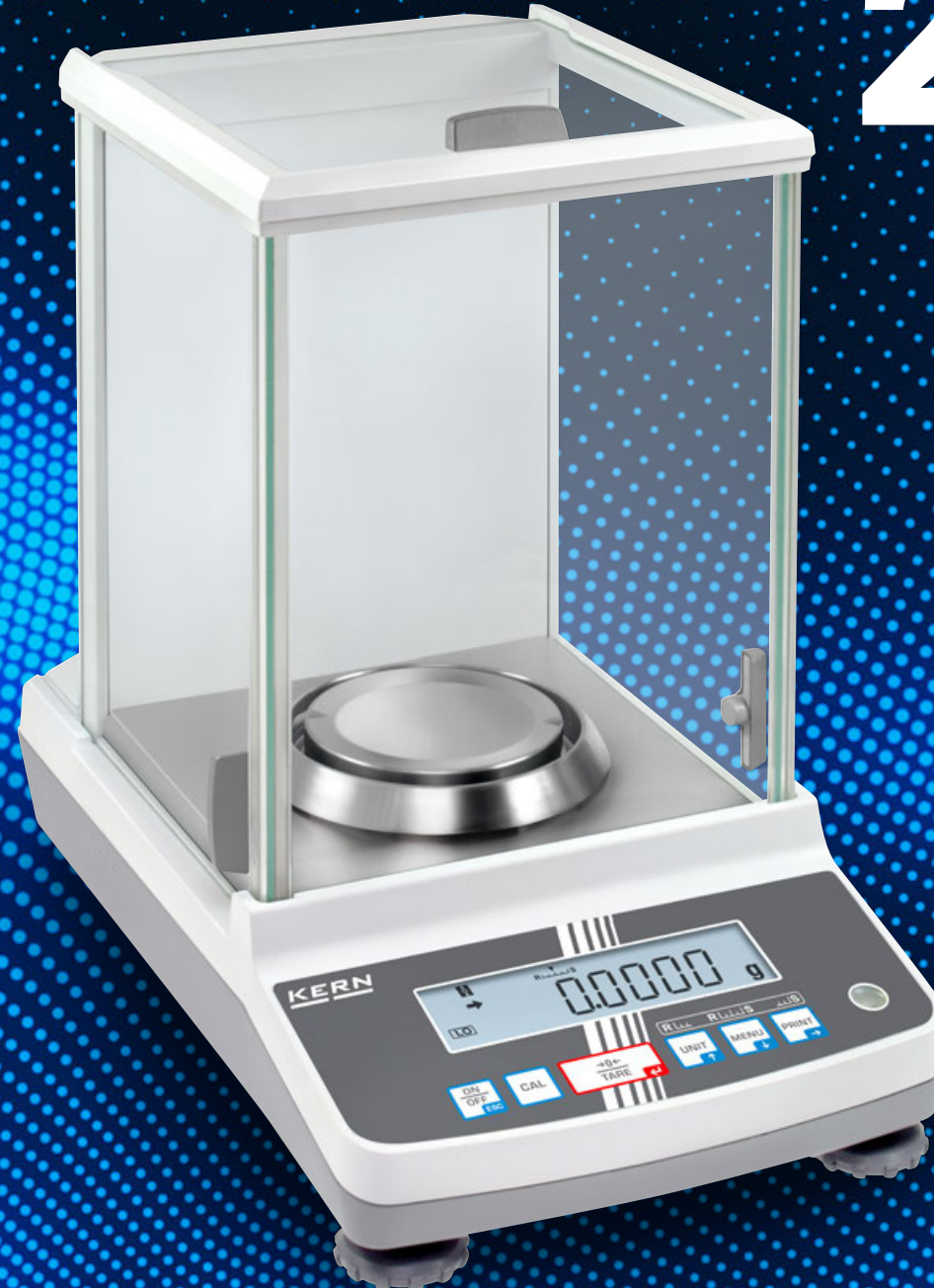









































NEW WEBSHOP ONLINE!
www.kern-sohn.com

BALANCES & TEST SERVICE for laboratory, industry and food industry

<p>1769 Ancestor Johann Jakob Sauter built the Hahn inclination scale out of iron, a foundation stone for weighing in Southern Germany</p>	<p>1844 KERN is founded – precision balances are produced</p>	<p>1863 A proud Gottlieb Kern with his staff</p>	<p>1880 Pharmaceutical balance with Aesculap</p>	<p>1923 Inflation – KERN wages are paid with self printed currency</p>
<p>1980 The electronic balance ousts mechanical devices</p>	<p>1994 Accredited DKD laboratory (ISO 17025)</p>	<p>2000 New premises in Balingen</p>	<p>2002 Existing QM system certification in accordance with DIN EN ISO 9001:2000 standards</p>	<p>2007 Approval for the manufacture of medical products (DIN EN 13485 and 93/42/EEC)</p>
<p>2008 Authorisation for initial verification by the manufacturer (2009/23/EC)</p>	<p>2009 Approval for the manufacture and sale of height rods (DIN EN 13485 and 93/42/EEC)</p>	<p>2012 Verification point for non-automatic balances and test weights. New customer portal www.kern-sohn.com goes live</p>	<p>2014 Expansion of the product range to include optical instruments (microscopes and refractometers)</p>	<p>2015 Inauguration of Ziegelei 2.0 with computer-controlled high-bay warehouse</p>
<p>2017 Come with KERN into the digital future: Expansion of the model ranges compatible with Industry 4.0, as well as the related services</p>	<p>2019 Significant anniversary year! 25 years of accredited DAkkS/DKD laboratory 175 years of KERN & SOHN 250 years of balance manufacture in the Sauter family-owned company</p>	<p>2020 Construction of Ziegelei 3.0, extension of administration building</p>		



KERN Pictograms

 Internal adjusting: Quick setting up of the balance's accuracy with internal adjusting weight (motordriven)	 KERN Communication Protocol (KCP): It is a standardized interface command set for KERN balances and other instruments, which allows retrieving and controlling all relevant parameters and functions of the device. KERN devices featuring KCP are thus easily integrated with computers, industrial controllers and other digital systems	 Battery operation: Ready for battery operation. The battery type is specified for each device
 Adjusting program CAL: For quick setting up of the balance's accuracy. External adjusting weight required	 GLP/ISO log: The balance displays serial number, user ID, weight, date and time, regardless of a printer connection	 Universal mains adapter: with universal input and optional input socket adapters for A) EU, CH, GB B) EU, CH, GB, USA C) EU, CH, GB, USA, AUS
 Easy Touch: Suitable for the connection, data transmission and control through PC, tablet or smartphone. For details see page 131	 GLP/ISO log: With weight, date and time. Only with KERN printers, see page 170-172	 Mains adapter: 230V/50Hz in standard version for EU, CH. On request GB, USA or AUS version available
 Memory: Balance memory capacity, e.g. for article data, weighing data, tare weights, PLU etc.	 Piece counting: Reference quantities selectable. Display can be switched from piece to weight	 Power supply: Integrated in balance. 230V/50Hz standard EU. More standards e.g. GB, USA or AUS on request
 Alibi memory: Secure, electronic archiving of weighing results, complying with the 2014/31/EU standard. For details see page 223	 Recipe level A: The weights of the recipe ingredients can be added together and the total weight of the recipe can be printed out	 Weighing principle: Strain gauges Electrical resistor on an elastic deforming body
 Data interface RS-232: To connect the balance to a printer, PC or network	 Recipe level B: Internal memory for complete recipes with name and target value of the recipe ingredients. User guidance through display	 Weighing principle: Tuning fork A resonating body is electromagnetically excited, causing it to oscillate
 RS-485 data interface: To connect the balance to a printer, PC or other peripherals. Suitable for data transfer over large distances. Network in bus topology is possible	 Totalising level A: The weights of similar items can be added together and the total can be printed out	 Weighing principle: Electromagnetic force compensation Coil inside a permanent magnet. For the most accurate weighings
 USB data interface: To connect the balance to a printer, PC or other peripherals	 Percentage determination: Determining the deviation in % from the target value (100 %)	 Weighing principle: Single cell technology: Advanced version of the force compensation principle with the highest level of precision
 Bluetooth* data interface: To transfer data from the balance to a printer, PC or other peripherals	 Weighing units: Can be switched to e.g. nonmetric units at the touch of a key. See balance model. Please refer to KERN's website for more details	 Verification possible: The time required for verification is specified in the pictogram
 WiFi data interface: To transfer data from the balance to a printer, PC or other peripherals	 Weighing with tolerance range: (Checkweighing) Upper and lower limiting can be programmed individually, e.g. for sorting and dosing. The process is supported by an audible or visual signal, see the relevant model	 DAkkS calibration possible (DKD): The time required for DAkkS calibration is shown in days in the pictogram
 Control outputs (optocoupler, digital I/O): To connect relays, signal lamps, valves, etc.	 Hold function: (Animal weighing program) When the weighing conditions are unstable, a stable weight is calculated as an average value	 Factory calibration (ISO): The time required for Factory calibration is shown in days in the pictogram
 Analogue interface: to connect a suitable peripheral device for analogue processing of the measurements	 Protection against dust and water splashes IPxx: The type of protection is shown in the pictogram. For details see page 58	 Package shipment: The time required for internal shipping preparations is shown in days in the pictogram
 Interface for second balance: For direct connection of a second balance	 Suspended weighing: Load support with hook on the underside of the balance	 Pallet shipment: The time required for internal shipping preparations is shown in days in the pictogram
 Network interface: For connecting the scale to an Ethernet network		







KERN – measuring technology and testing services from a single source



Balances & Test service catalogue Provides a complete overview of the KERN line of balances, test weights, and services such as verification, calibration, etc.	Medical scales catalogue Complete line of medical scales, from infant scales to patient scales, chair scales and adiposity scales, as well as hand grip dynamometers, chemist's balances and veterinary scales.	Microscopes & refractometers catalogue Extensive range in the area of optical instruments, such as, biological microscopes, stereo microscopes, metallurgical microscopes, polarisation microscopes as well as analogue and digital refractometers.	SAUTER measuring equipment catalogue Test instruments for industry and commerce, such as force, coating thickness, material thickness and calibration service.	DAkkS calibration service brochure Detailed information on topics pertaining to the calibration and verification of balances, test weights, and force measuring devices.
---	---	---	--	--

Your advantages

fast • 24 hours delivery service for products in stock – ordered today, on its way tomorrow • Sales & service hotline available from 8:00 am to 6:00 pm	competent • DAkkS accreditation DIN EN ISO/IEC 17025 • Certified QM system DIN EN ISO 9001 • Authorisation for initial verification by the manufacturer 2014/31/EU • Medical certifications DIN EN ISO 13485 and 93/42/EWG	versatile • One-stop shopping: from pocket balances through to 12 t crane balance – everything from one supplier • Find the product you want at lightning speed with the “Balance Quick-Finder” at www.kern-sohn.com
reliable • Up to 3 years warranty • Precision in weighing technology for more than 175 years		

 Order hotline +49 7433 9933-0	 Online Shop www.kern-sohn.com
 Service hotline +49 7433 9933-199	 E-mail order info@kern-sohn.com
 Calibration hotline +49 7433 9933-196	 Fax order +49 7433 9933-146
 Our team of consultants will assist you from Monday to Friday from 8:00 am to 6:00 pm	

Keyword index

A Adiposity scales_____ see website Accessories_____ 169-181 Alibi memory_____ 109, 102 Aluminium sample plate_____ 47-49 Analogue refractometer_____ see website Analytical balances_____ 36-45 Animal scales_____ 54-55, 57, 65, 72, 95-109, _____ 113, 117-125, 138-140, 156-160	I Information_____ 223-226 Interface cable_____ 173 Internet_____ 2, 6-8 Ioniser_____ 37-45, 180 IP 65...68 protected scales_____ 63-67, 69-72, _____ 105-107, 117, 122, 125 ISO calibration_____ 221-222	R Recalibration_____ 218 Refractometers, digital_____ see website Retail balances_____ 73-76 Roller conveyor_____ 181 Round fiberglass filter_____ 47-49 RS-232/Bluetooth-Adapter_____ 177 RS-232/Ethernet-Adapter_____ 176 RS-232/USB-Adapter_____ 178 RS-232/WiFi-Adapter_____ 176
B Baby scales_____ see website Bench scales_____ 50-58 Bluetooth/RS-232 Adapter_____ 177 Body fat scales_____ see website	J Junction box_____ 150	S Safety Set_____ 184 Semi-micro balances_____ 39, 42, 45 Shop balances_____ 73-76 Signal lamp_____ 178 Software_____ 6-8, 175 Spring balances_____ see website Stainless steel scales _ 63-67, 69-72, 105-107, _____ 117, 122, 125
C Calibration_____ 210-220 Calibration Service_____ 210-220 Carat balances ____ 13, 17, 24-35, 37-42, 44-45 Catalogues, Brochures, Flyer_____ 2, 226 Chair scales_____ see website Chair weighers_____ see website Coating thickness gauges _____ see website Column_____ 179 Control of checking equipment_ 210-222, 225 Counting scales_____ 77-89 Counting systems_____ 87-89 Crane scales_____ 161-168	L Laboratory balances_____ 14-49 Length measuring devices_____ see website Lexicon_____ 223-225 Load cells_____ 145-150 Luggage scale_____ 155	T Tare pan_____ 179 Temperature calibration set_____ 47-49 Tensile force measurement device_____ 162-162 Terminals_____ 129, 136-140 Test service_____ 210-222 Test stands_____ see website Test weights_____ 183-209 Touchscreen scales_____ 108-109 Tweezers_____ 206
D DakkS/DKD_____ 210-220 Density determination _____ 16-17, 25-26, 28, _____ 30-31, 33-35, 38-45, 104 Display devices_____ 129, 136-140 Drive-through scale_____ 123-125 Drying balance_____ 46-49	M Material thickness gauge_____ see website Measuring cells_____ 145-150 Mechanical balances (spring balances)_____ see website Medical scales_____ see website Microscopes, biological_____ see website Microscopes, metallurgical _____ see website Microscopes, polarisation_____ see website Microscopes, stereo_____ see website Minimum sample weight_____ 215 Mobile pallet weigher_____ 151-152 Moisture analysers_____ 46-49	U Underfloor weighing, accessories_____ 16-17, _____ 25-26, 28, 30-31, 33-35, 38-45, 104
E Earth's gravitational force_____ 226 EasyTouch App_____ 6-8 Equipment qualification_____ 216 Ethernet/RS-232 Adapter_____ 176 Explosion hazard_____ 226	P Pallet scales_____ 119-122 Personal floor scales_____ see website Personal scales _____ see website Pictogram overview_____ 2 Platform scales_____ 91-109 Platforms_____ 130, 141-144 Plummet, density determination_____ 179 Pocket balances_____ 11-13 Power supply adapter set_____ 178 Pre-packaging legislation (FPVO)_____ 224 Precious stones plate_____ 32 Precision balances_____ 14-49 PREMIUM+ WEIGHTS_____ 184 Price computing scales_____ 73-75 Printers_____ 170-172 Protective dust cover_____ 179	V Verification_____ 219, 223 Verification plug_____ 219, 223
F Factory calibration_____ 221-222 Floor scales_____ 110-125 Foot switch_____ 107, 140 Force gauges_____ see website	G Grain balances_____ see website	W Weighing beams_____ 118 Weighing bridges_____ 141-144 Weighing Systems Industry 4.0_____ 126 Weighing table_____ 180 Weighing transmitter, digital_____ 128 Wheelchair platform scales _____ see website WiFi/RS-232 Adapter_____ 176
H Handrail scales_____ see website Hanging scales_____ 153-168 Hardness tester_____ see website Height rods_____ see website Hydrostatic balances_____ 16-17, 25-26, 28, _____ 30-31, 33-35, 38-45, 104		

*The Bluetooth® word mark and logos are registered trademarks owned by Bluetooth SIG, Inc. and any use of such marks by KERN & SOHN GmbH is under license. Other trademarks and trade names are those of their respective owners.

Product group index 2021

01	Pocket balances		12 – 13
02	School balances		14 – 19
03	Precision balances		20 – 35
04	Analytical balances		36 – 45
05	Moisture analysers		46 – 49
06	Bench scales		50 – 58
07	Food (kitchen/stainless steel/IP65...68 protection)		59 – 72
08	Price computing scales		73 – 76
09	Counting scales/Counting systems		77 – 90
10	Parcel scales/Platform scales		91 – 109
11	Floor scales/Pallet scales/Drive-through scales		110 – 125
12	Weighing Systems Industry 4.0		126 – 135
13	Display devices/Platforms/Weighing bridges		136 – 144
14	Pallet truck scales		145 – 150
15	Hanging scales/Crane scales		151 – 168
16	Accessories		169 – 182
17	Test weights		183 – 209
18	DAkkS Calibration Service and Verification service		210 – 222

Do you have questions about our products? Our customer consultants will be pleased to assist you:

UK, IE, IS, FR, Maghreb, BE, LUX



Maren Möwert
Tel. +49 7433 9933-132
Mobil +49 151 46143240
maren.moewert@kern-sohn.com

DK, SE, FI, NO, PL, LV, LT, EE



Florian Bächle
Tel. +49 7433 9933-118
Mobil +49 151 44611168
florian.baechle@kern-sohn.com

GR, CY, BG, HU, RO, SK, CZ, AL, Ex-Yugoslavia, GUS



Aleksandar Delić
Tel. +49 7433 9933-120
Mobil +49 151 11196197
aleksandar.delic@kern-sohn.com

North America, Near- & Middle East, Africa, Asia, Oceania, TR



Corinna Klaass
Tel. +49 7433 9933-215
Mobil +49 151 44568364
klaass@kern-sohn.com

NL, Germany (CP 4, 7)



Taras Mikitisin
Tel. +49 7433 9933-143
Mobil +49 171 5590115
mikitisin@kern-sohn.com

PT, ES, South & Central America



Jesús Martínez
Tel. +49 7433 9933-209
Mobil +49 171 3059661
jesus.martinez@kern-sohn.com

Accountancy



Jutta Osswald
Tel. +49 7433 9933-215
jutta.osswald@kern-sohn.com

Marketing Management



Thomas Fimpel
Tel. +49 7433 9933-130
fimpel@kern-sohn.com

Board of Management



Albert Sauter
Tel. +49 7433 9933-157
albert.sauter@kern-sohn.com

Sales Management



Stephan Ade
Tel. +49 7433 9933-121
Mobil +49 171 3060086
ade@kern-sohn.com

Deputy Sales Management



Hendrik Neff
Tel. +49 7433 9933-161
Mobil +49 171 3059946
hendrik.neff@kern-sohn.com

DAkKS Calibration Service



FR, BeNeLux, DK, TR, GR, Africa,
America, Oceania, DE (CP 8, 9)
Friederike Alex
Tel. +49 7433 9933-123
friederike.alex@kern-sohn.com



EN, IE, FI, NO, S, AUS, ES, PT, IT,
DE (CP 5, 6, 7)
Balbina Pietrzak
Tel. +49 7433 9933-210
balbina.pietrzak@kern-sohn.com



GR, TR, Eastern Europe, Baltic
States, CIS, South East Asia, AT, CH,
DE (CP 0, 1, 2, 3, 4)
Waldemar Fleitling
Tel. +49 7433 9933-163
fleitling@kern-sohn.com

KERN Hotlines +49 7433 9933- ...

Service hotline	199	for general technical questions about your KERN or SAUTER product
System solutions Industry 4.0	200	for all technical questions concerning the interlocking of the latest information and communication technology with our scales, measuring cells and measuring devices as well as questions about KERN software
Industrial scales	333	for all technical questions concerning our basic scales (laboratory & industry), pocket balances, school balances, bench scales, price-computing scales, platform scales, counting scales, counting systems, floor scales, pallet truck scales, crane scales
Laboratory and analytical balances	444	for all technical questions concerning our high quality precision balances, analytical balances (especially with electromagnetic force-compensated measuring systems, tuning fork and high application density)
Medical scales	499	for all technical questions concerning our baby scales, personal scales, handrail scales, chair scales, wheelchair scales, dynamometers
SAUTER measuring instruments	555	for all technical questions concerning our SAUTER measuring instruments, test benches, force measuring accessories (clamps etc.), SAUTER software
Moisture analysers	599	for all technical questions concerning our moisture analyzers
Optical devices	777	for all technical questions concerning our microscopes, microscope cameras, refractometers, etc.

KERN SEGMENT SPECIALISTS

Laboratory



Sales departement

Aleksandar Delić

Tel. +49 7433 9933-120

Mobil +49 151 11196197

aleksandar.delic@kern-sohn.com



Product management

Timo Koch

Tel. +49 7433 9933-212

timo.koch@kern-sohn.com

Industry



Sales departement

Florian Bächle

Tel. +49 7433 9933-118

Mobil +49 151 446 11168

florian.baechle@kern-sohn.com



Product management

Sebastian Duft

Tel. +49 7433 9933-319

sebastian.duft@kern-sohn.com

Medical sector



Sales departement

Jesús Martínez

Tel. +49 7433 9933-209

Mobil +49 171 3059661

jesus.martinez@kern-sohn.com



Product management

Liberatus Demischew

Tel. +49 7433 9933-251

liberatus.demischew@kern-sohn.com

Test weights



Sales departement

Taras Mikitisin

Tel. +49 7433 9933-143

Mobil +49 171 5590115

mikitisin@kern-sohn.com

Food



Sales departement

Sebastian Hipp

Tel. +49 7433 9933-168

Mobil +49 1751 72838959

sebastian.hipp@kern-sohn.com



Product management

Christoph Sauter

Tel. +49 7433 9933-286

christoph.sauter@kern-sohn.com

EasyTouch



Sales departement

Albert Sauter

Tel. +49 7433 9933-157

albert.sauter@kern-sohn.com

NEW WEBSHOP

The new KERN Webshop - now online!

The fresh design offers a lot of useful information about professional weighing and measuring technology from KERN.

It also offers many new features that make information and ordering easy and convenient.

You will find a small foretaste of the new content on the following page - or discover it for yourself at www.kern-sohn.com



Large slider images guide you to the KERN product worlds

— ONLINE NOW:

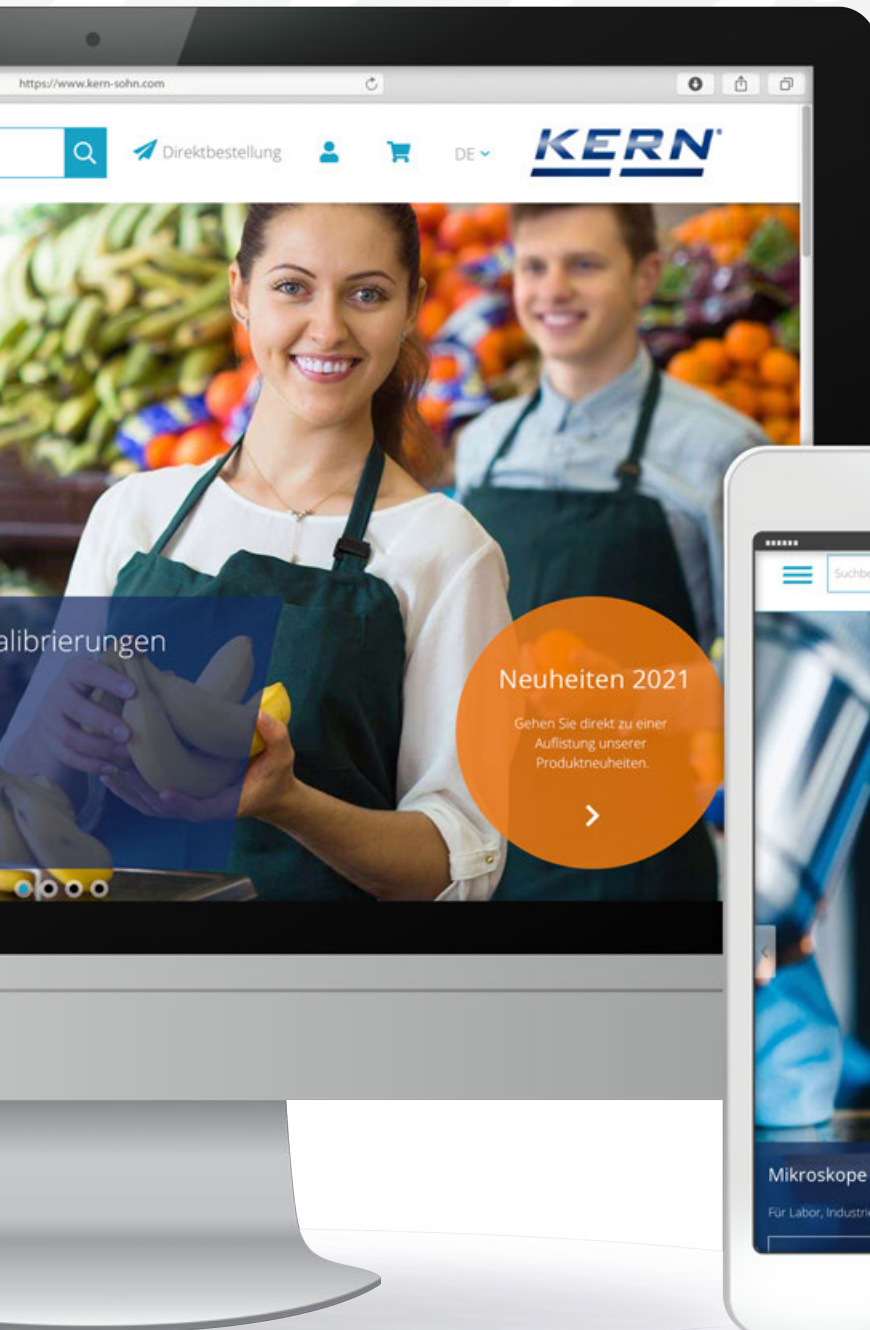

KERN-SOHN.COM

NEW FEATURES

KERN product categories

Simple and well structured for a quick overview

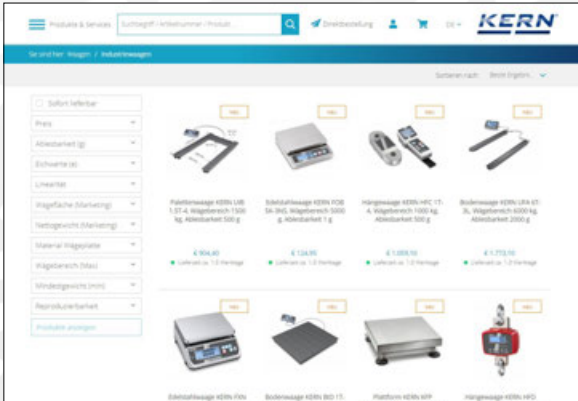

Improved filter function

Enables the targeted pre-selection of product properties

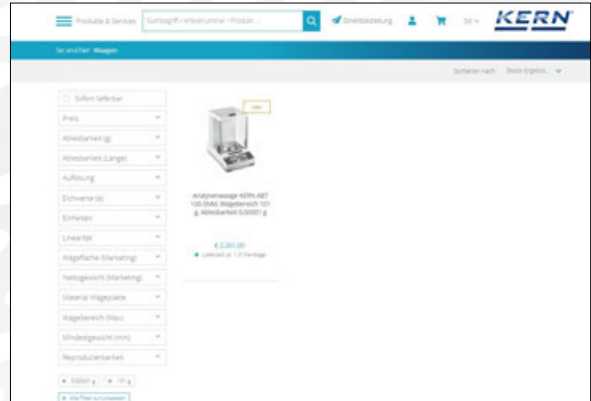

KERN Product search

For faster finding the desired products

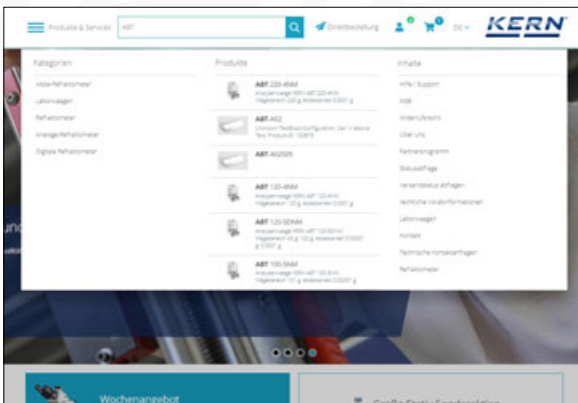

Clear product presentation

Shows all important facts at a glance, with 360° view of the models



KERN quick order form with availability check

See immediately if your products are in stock and available

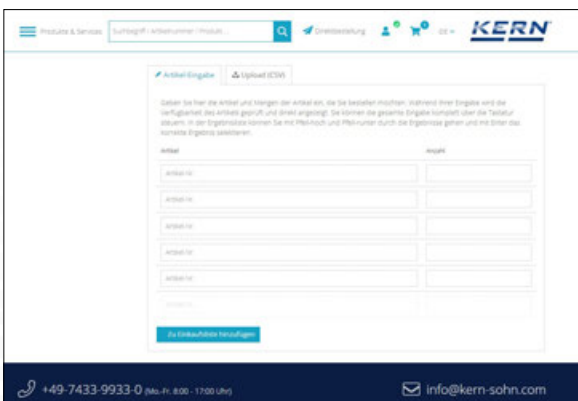

The KERN Partner Program

Convenient access to your customer account: accelerates the ordering process and provides full transparency of your orders

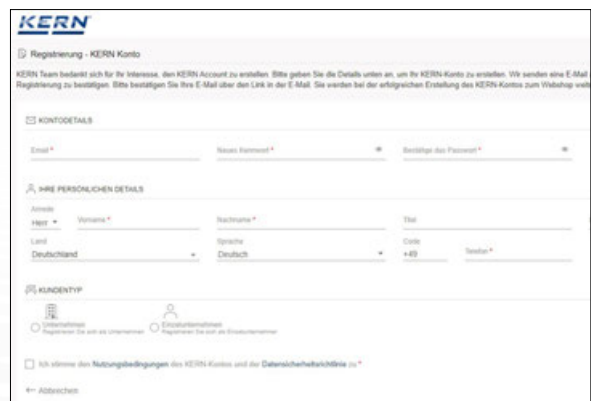

Convenient working and even easier online ordering with the new KERN Webshop:
Now online at www.kern-sohn.com

NEWS 2021

Also 2021 we have many new models for you in our program

Analytical balances KERN ALS/ALJ

Analytical balance with high weighing capacity, graphic display and convenient recipe function



Further details ▶ Page 38/39
from € 960,-

Moisture analysers KERN DLB

Moisture analyzer with intuitive graphic display and step-by-step user guidance in 6 languages



Further details ▶ Page 49
only € 1150,-

Design kitchen scale KERN FGE

Precise design kitchen scale for kitchen, canteen, gastronomy



Further details ▶ Page 61
from € 19,80*
*unit price within the set of 5

Counting scale KERN CIB

Robust counting scale with large article memory, convenient operating philosophy and checkweighing display, counting resolution up to 30,000 points



Further details ▶ Page 80
only € 240,-

Drive-through scale KERN NIB

Compact and robust drive-through scale (IP67), especially mobile thanks to handle, wheels and light construction

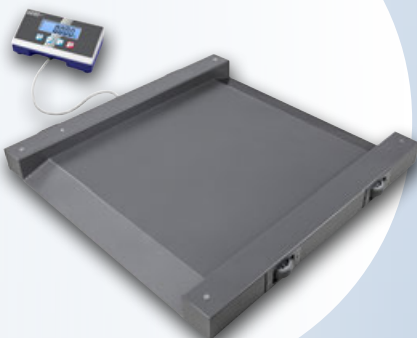

Further details ▶ Page 123
only € 640,-

KERN EasyTouch App

Turn your balance into a powerful weighing system with the KERN EasyTouch App



Further details ▶ Page 131-135
from € 690,-

KERN scales and components with KCP

Aim & advantages:

Searching and remote control of the balances using external control devices or computers with the KERN Communication Protocol (KCP).

KCP is a standardised interface command structure for KERN balances and other instruments which allows you to recall and manage all relevant parameters and device functions.

You can therefore simply connect KERN devices with KCP to computers, industrial control systems and other digital systems.

In a large number of cases the KCP is compatible with the MT-SICS protocol.

KERN models with KCP:

Balance	Model		Page
	KERN		
A/D converter box	YKV-01/ YKV-02	Modern A/D converter for the rapid recording of weighing data and forwarding it to the most varied output channels such as tablets, networks, SPS controllers, etc.	128
Digital platform	KDP	Universal weighing platforms for flexible connection in process chains	130
Compact laboratory balance	PFB	Quick-displaying precision balance, now with larger housing for more secure footing	27
Compact laboratory balance	EWJ	High-quality precision balance with automatic internal adjustment, also with EC type approval [M]	29
Counting scale	CPB	Professional model, also with EC type approval [M], counting resolution up to 60,000 points	82
Counting scale	CFS	Professional, high-resolution counting scale with 100 item memories and second balance interface, counting resolution up to 75,000 points	83
Counting scale	IFS	Industrial counting scale with convenient decimal keypad for easy data entry – now also with EC type approval [M], counting resolution up to 75000 points	85
Counting system	CCS	Counting system to count the smallest parts in the largest quantities, counting resolution up to 999,999 points	88/89
Platform scale	SFB	Stainless steel platform scales with IP65/67 protection, also with XL platform or EC type approval [M]	71
Platform scale	EOC	All-round parcel scale with practical Flip/Flop display device for greatest ease of use	100/101
Platform scale	IOC	All-round platform scale with a range of communication options and EC type approval [M]	102
Platform scale	IFB	High-resolution industrial scale in heavy version with EC type approval [M], now also up to [Max] 600 kg	103
Floor scale	BID	Floor scale with EC type approval [M] and the best price-performance ratio	113/114
Floor scale	BFB	Weighing bridge with screwed-on weighing plate (IP67) and XXL display device, with EC type approval [M]	115/116
Floor scale	BFN	Stainless steel weighing bridge with screwed-on weighing plate (IP68) and stainless steel display device (IP65), with EC type approval [M]	117
Weighing beams	UFA	Highly versatile weighing beams (IP67) for large loads to 6 t	118
Pallet scale	UFB	Pallet scale with steel load support (IP67) and EC type approval [M]	121
Drive-through scale	NFB	Drive-through scale (IP67) with XXL display device and EC type approval [M]	124
Drive-through scale	NFN	Stainless steel drive-through scale (IP68) with stainless steel display device (IP65), with EC type approval [M]	125
Display device	KFB-TM	Display device with large digits – easy to read	138
Display device	KFS-TM	Professional indicator with 3 displays, also with EC type approval [M]	138
Display device	KFN-TM	Stainless steel display device with IP65 protection and superior display size	140
Display device	KIB-TM	Practical Flip/Flop display device for greatest ease of use	139
Display device	KFT-TM	KERN Easy-Touch display device – the intuitive way to weigh	see internet





Pocket balances

Pocket size precision

Pocket balances are the ideal helpers whenever mobility and high precision are required. Since they have fewer keys, operation is simple and fast. Different weighing units stored in the pocket balance, such as g, oz, ct, gn, etc., make them universally usable. An integrated calculator allows you to use the measured weight immediately in calculations, to e.g. determine a price, quantity, average value and much more. Compact in size and well protected with a flap or protective cover, which can be used as a convenient taring container, the pocket balance is always a useful tool for mobile weighing.

- In production, to control of production weights or during the picking of small parts
- In quality control for the quick testing of small parts like plastic parts from injection moulding machines, milled parts, screws, etc.
- For mobile weighing, on-site sampling, and fast analysis wherever there's no power outlet
- In hobbies and sports, e.g. when filling black powder, weighing parts from modelling kits etc.
- In commerce, for the fast determination of the weights of coins, jewellery, precious stones, etc.
- In veterinary sector for the weighing of small animals, the mixing of food, etc.
- In the food sector for the preparation of spice or tea mixes, for the weighing of food in line with a diet sheet.

Quick-Finder Pocket balances

Readability [d] g	Weighing capacity [Max] g	Model KERN	Price excl. of VAT ex works €	Page	 DAYS	 CAL EXT	 BATT
0,001	50	TGD 50-3CS05 	260,-*	13	1	●	●
0,002	10	CM 50-C2N 	90,-	13	1	●	●
0,01	60	CM 60-2N	79,-	12	1	●	●
0,01	150	TGC 150-2S05	99,-*	12	1	●	●
0,1	150	TEE 150-1	40,-	12	1	●	●
0,1	150	CM 150-1N	50,-	12	1	●	●
0,1	320	CM 320-1N	55,-	12	1	●	●
0,1	500	TGC 500-1S05	99,-*	12	1	●	●
1	1000	CM 1K1N	52,-	12	1	●	●
1	1000	TGC 1K-3S05	99,-*	12	1	●	●

*Price set of 5 units

 = Carat balances

● = standard

○ = option

KERN TGC

Page 12

- High-resolution pocket balance
- Especially fast response and settling time
- Particularly flat design
- Stainless steel weighing plate

only €
19,80*

* Price set of 5 units
excl. of VAT ex works



01



KERN TEE

Designer pocket balance at a bargain price

KERN CM

Pocket balance with integrated pocket calculator

KERN TGC

Slim pocket balance with large stainless steel weighing plate and practical tare pan

STANDARD

CAL EXT BATT 1 DAY

STANDARD

CAL EXT UNIT BATT 1 DAY

STANDARD

CAL EXT UNIT BATT 1 DAY

OPTION

DAkKS +3 DAYS

OPTION

DAkKS +3 DAYS

OPTION

DAkKS +3 DAYS

- Simple and convenient 2-key operation
- Cover made of shock proof plastic as protection against pressure and dust. Can also be used as a tare cup

- Simple and convenient 4-key operation
- Hard case cover as protection against pressure and dust
- Robust, handy, well protected
- Integrated calculator

- High-resolution pocket balance with particularly rapid reaction and stabilisation time, which means that you can work extremely efficiently
- Particularly flat design
- Cover made of shock proof plastic as protection against pressure and dust. Can also be used as a tare cup
- Stainless steel weighing plate, which makes cleaning easy and hygienic
- **Note:** The models are only delivered in a set of 5 units. i.e. the prices given in the table refer to a delivery of 5 items. Cannot be delivered individually. The calibration prices given here refer to calibration of a single balance

Tip: KERN pocket scales are also ideal as a customer gift or for personalised marketing and sales campaigns. We are happy to print your logo on the cover, the lid or the packaging, from 100 pieces. Please inquire details

KERN	TEE 150-1*	CM 60-2N	CM 150-1N	CM 320-1N	CM 1K1N	TGC 150-2S05	TGC 500-1S05	TGC 1K-3S05
Weighing capacity [Max] g	150 g	60 g	150 g	320 g	1000 g	150 g	500 g	1000 g
Readability [d]	0,1 g	0,01 g	0,1 g	0,1 g	1 g	0,01 g	0,1 g	1 g
LCD display	backlit, digit height 9 mm	backlit, digit height 12 mm				backlit, digit height 12 mm		
Dimensions of weighing plate	W×D 60×64 mm	W×D 70×80 mm				ø 81 mm		
Overall dimensions	W×D×H 67×100×22 mm	W×D×H 85×130×25 mm				W×D×H 100×130×18 mm		
Power supply	Batteries included, 2× 1,5 V AAA, operating time up to 50 h	Batteries included, 2× 1,5 V AAA, AUTO-OFF function to preserve battery life, operating time up to 33 h				Batteries included, 2× CR2032, operating time up to 33 h		
Net weight	100 g	180 g				200 g		
Permissible ambient temperature	5 °C/35 °C					0 °C/40 °C		
Price € , excl. of VAT, ex works	40,-	79,-	50,-	55,-	52,-	99,-*	99,-*	99,-*
Option DAkKS Calibr. Certificate	963-127, 78,-							

* ONLY WHILE STOCKS LAST!

*Price set of 5 units excl. of VAT exworks

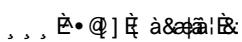



KERN CM-C

Pocket balance with carat display – ideal for jewellers



KERN TGD

Compact pocket carat balance for precision weighing of jewellery and precious stones



STANDARD

- CAL EXT
- UNIT
- BATT
- 1 DAY

STANDARD

- CAL EXT
- UNIT
- BATT
- 1 DAY

OPTION

- DAkKs
- +3 DAYS

OPTION

- DAkKs
- +3 DAYS

- Hard case cover as protection against pressure and dust
- Adjusting weight standard
- Draft shield against air movements standard
- Weighing pan standard

- Simple and convenient 4-key operation
- Can be switched over from g to ct, gn, dwt, ozt, oz at the touch of a key
- Innovative touchscreen: Large touch-sensitive, backlit touch display with very good contrast for easy operation and convenient reading
- Hard case cover as protection against pressure and dust
- Stainless steel weighing plate, which makes cleaning easy and hygienic
- Weighing pan standard
- Powder scale with Grain division (gn), ideal for sport shooters, reloaders etc. for self-filling cartridge cases
- USB cable for power supply as standard
- **1** Delivered in appealing packaging
- **Note:** The models are only delivered in a set of 5 units. i.e. the prices given in the table refer to a delivery of 5 items. Cannot be delivered individually. The calibration prices given here refer to calibration of a single balance

Tip: KERN pocket scales are also ideal as a customer gift or for personalised marketing and sales campaigns. We are happy to print your logo on the cover, the lid or the packaging, from 100 pieces. Please inquire details

KERN	CM 50-C2N*	TGD 50-3CS05
Weighing capacity [Max] g	10 g 50 ct	50 g 250 ct
Readability [d]	0,002 g 0,01 ct	0,001 g 0,005 ct
LCD display	digit height 9 mm	backlit, digit height 12 mm
Dimensions of weighing plate	W×D 50×40 mm	ø 65 mm
Overall dimensions	W×D×H 85×130×25 mm	W×D×H 96×149×36 mm
Power supply	Batteries included, 2×1,5 V AAA, AUTO-OFF function to preserve battery life, can be switched off, operating time up to 30 h	Batteries included, 4×1,5 V AAA, operating time up to 150 h without backlight
Net weight	200 g	
Permissible ambient temperature	5 °C/35 °C	5 °C/35 °C
Price €, excl. of VAT, ex works	90,-	260,-**
Option DAkKs Calibr. Certificate	963-127, 78,-	

1 * ONLY WHILE STOCKS LAST!

**Price set of 5 units excl. of VAT exworks

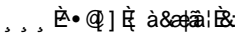

02

School balances

As entry-level models, KERN school balances cover the most important basic applications of laboratory balances and offer simple operation, easy readability and an optimal price-performance ratio. The mostly stackable precision balances can be used flexibly and independent of location thanks to battery operation and are therefore the ideal choice for school or teaching purposes.

Our recommendation: Brand new in the range is the school balance EHA (quality code AA), a real and affordable all-rounder for laboratory, industry and teaching purposes.

Quick-Finder School balances

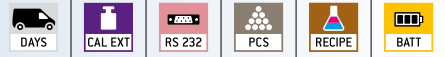
Readability [d] g	Weighing capacity [Max] g	Model KERN	Price excl. of VAT ex works €	Page	Quality code QUA LITY	 For an explanation on the pictos, see front flap					
						DAYS	CAL EXT	RS 232	PCS	RECIPE	BATT
0,001	100	EMB 100-3	195,-	16	AA	1	●				●
0,001	200	EMB 200-3	210,-	16	AA	1	●				●
0,001	200	EMB 200-3V	250,-	17	AA	1	●	●			●
0,001	300	EMS 300-3	260,-	18	AA	1	●		●	●	●
0,01	200	EMB 200-2	125,-	16	AA	1	●				●
0,01	500	EMB 500-2S	115,-	15	AA	1	●				●
0,01	500	EHA 500-2	90,-	19	AA	1	●		●		●
0,01	600	EMB 600-2	160,-	16	AA	1	●				●
0,01	1000	EMB 1000-2	195,-	16	AA	1	●				●
0,01	2000	EMB 2000-2	205,-	16	AA	1	●				●
0,01	2000	EMB 2000-2V	250,-	17	AA	1	●	●			●
0,01	3000	EMS 3000-2	240,-	18	BA	1	●		●	●	●
0,1	200	EMB 200-1SS05	150,-*	15	AA	1	●				●
0,1	500	EMB 500-1SS05	170,-*	15	AA	1	●				●
0,1	500	EMB 500-1	55,-	16	AA	1	●				●
0,1	500	EMB 500-1BE	55,-	16	AA	1	●				●
0,1	500	EHA 500-1	65,-	19	AA	1	●		●		●
0,1	1000	EHA 1000-1	65,-	19	AA	1	●		●		●
0,1	1200	EMB 1200-1	78,-	16	AA	1	●				●
0,1	3000	EMB 3000-1	125,-	16	AA	1	●				●
0,1	3000	EMB 3000-1S	99,-	15	AA	1	●				●
0,1	3000	EHA 3000-1	90,-	19	AA	1	●		●		●
0,1	6000	EMB 6000-1	160,-	16	AA	1	●				●
0,1	6000	EMS 6K0.1	160,-	18	AA	1	●		●	●	●
0,1	12000	EMS 12K0.1	205,-	18	AA	1	●		●	●	●
1	2000	EMB 2000-0SS05	150,-*	15	AA	1	●				●
1	2200	EMB 2200-0	57,-	16	AA	1	●				●
1	3000	EHA 3000-0	65,-	19	AA	1	●		●		●
1	5000	EMB 5000-0SS05	170,-*	15	AA	1	●				●
1	5200	EMB 5.2K1	60,-	16	AA	1	●				●
1	6000	EMS 6K1	80,-	18	AA	1	●		●	●	●
1	12000	EMS 12K1	85,-	18	AA	1	●		●	●	●
5	5200	EMB 5.2K5	55,-	16	AA	1	●				●

* Price set of 5 units

● = standard

○ = option



from €
65,-

KERN EHA

Page 19

- Large, shock-resistant stainless steel weighing plate
- Particularly flat design
- Large, bright LCD display
- Simple operation, suitable for school and teaching use



Models with addition -S05



The price breaker!
 Cheapest Laboratory balance in the KERN assortment
 from € **30,-****
 ** unit price within the set of 5, excl. of VAT ex works

The space miracle – stackable school balance for experiment-based teaching

Features

- Simple and convenient 2-key operation
- Tare function facilitates formulation work
- Particularly flat design
- Secure and non-slip positioning through rubber feet
- **1** Stackable for space-saving storage
- **2** A practical transport safety lock prevents the weighing technology from being overloaded when stacked, stored or during transportation

Technical data

- Large LCD display, digit height 15 mm
- Dimensions of weighing surface, plastic, Ø 120 mm
- Overall dimensions W×D×H 145×205×45 mm
- Optional battery operation, 2×1.5 V AA, standard, operating time up to 35 h, AUTO-OFF function to preserve the battery
- Net weight 2,0 kg
- Permissible ambient temperature 5 °C/35 °C
- **Note:** The models are only delivered in a set of 5 units. i.e. the price given in the table refers to a delivery of 5 items. Cannot be delivered individually. The calibration prices given here refer to calibration of a single balance

Accessories

- External universal mains adapter, with universal input and optional input socket adapters for EU, GB, USA, KERN YKA-03N, € 32,-

STANDARD: CAL EXT, UNIT, BATT, DMS, 1 DAY
 OPTION: MULTI, +3 DAYS, DAKKS

Model	Weighing capacity [Max] g	Readability [d] g	Reproducibility g	Linearity g	Quantity delivered (balance)	Price excl. of VAT ex works €	Option		Quantity delivered (DAkkS Calibr. Certificate)
							DAkkS KERN	DAkkS Calibr. Certificate €	
EMB 500-2S	500	0,01	0,02	± 0,03	1	115,- ↓	963-127	78,-	1
EMB 200-1SS05	200	0,1	0,2	± 0,3	5	150,-* ↓	963-127	78,-	1
EMB 500-1SS05	500	0,1	0,2	± 0,3	5	170,-* ↓	963-127	78,-	1
EMB 3000-1S	3000	0,1	0,2	± 0,3	1	99,- ↓	963-127	78,-	1
EMB 2000-OSS05	2000	1	2	± 3	5	150,-* ↓	963-127	78,-	1
EMB 5000-OSS05	5000	1	2	± 3	5	170,-* ↓	963-127	78,-	1

↓ Price reduction

* Price set of 5 units



Entry level laboratory balance with tremendous weighing performance

Features

- Simple and convenient 2-key operation
- Tare function facilitates formulation work
- Particularly flat design
- Ready for use: Batteries included
- **1** Ring-shaped draught shield standard, only for models with weighing plate size **A**, weighing space $\varnothing \times H$ 96×35 mm
- Hook for underfloor weighing standard
- **2** Note: KERN EMB 500-1BE Black Edition
- Note: With the optional auxiliary set for density determination KERN YDB-04 also well suited for school and teaching operation.

Technical data

- Large LCD display, digit height 15 mm
- Dimensions weighing surface
 - A** \varnothing 82 mm
 - B** \varnothing 105 mm
 - C** \varnothing 150 mm, see larger picture
- Weighing plate material
 - A** plastic, with conductive lacquer
 - B, C** plastic
- Net weight approx. 0,85 kg
- Batteries included, 9 V block, respectively 2×1.5 V AA
- Permissible ambient temperature 5 °C/35 °C

Accessories

- Stainless steel weighing plate, only for models with weighing plate size **B**, KERN EMB-A02, **€ 26,-**
- External universal mains adapter, with universal input and optional input socket adapters for EU, GB, USA, KERN YKA-03N, **€ 32,-**
- **3** Ancillary kit for density determination of liquids and solids with density > 1. Scope of supplies: Bridge for holding the beaker (\varnothing 102 mm), hook (H 139 mm), suitable for models with weighing plate size **A**, KERN YDB-04, **€ 40,-**

STANDARD

CAL EXT UNIT UNDER BATT DMS 1 DAY

OPTION

B MULTI DAKKS +3 DAYS

Model	Weighing capacity [Max] g	Readability [d] g	Reproducibility g	Linearity g	Housing dimensions W×D×H mm	Weighing plate	Price excl. of VAT ex works €	Option	
								DAKKS KERN	€
KERN EMB 100-3	100	0,001	0,001	± 0,005	170×244×54	A	195,-	963-127	78,-
EMB 200-3	200	0,001	0,001	± 0,005	170×244×54	A	210,-	963-127	78,-
EMB 200-2	200	0,01	0,01	± 0,02	170×244×39	B	125,-	963-127	78,-
EMB 600-2	600	0,01	0,01	± 0,03	170×244×39	B	160,-	963-127	78,-
EMB 1000-2	1000	0,01	0,01	± 0,05	170×244×54	C	195,-	963-127	78,-
EMB 2000-2	2000	0,01	0,01	± 0,05	170×244×54	C	205,-	963-127	78,-
EMB 500-1	500	0,1	0,1	± 0,2	170×244×39	C	55,-	963-127	78,-
EMB 500-1BE	500	0,1	0,1	± 0,2	170×244×39	C	55,-	963-127	78,-
EMB 1200-1	1200	0,1	0,1	± 0,3	170×244×39	C	78,-	963-127	78,-
EMB 3000-1	3000	0,1	0,1	± 0,3	170×244×39	C	125,-	963-127	78,-
EMB 6000-1	6000	0,1	0,1	± 0,3	170×244×39	C	160,-	963-128	94,-
EMB 2200-0	2200	1	1	± 2	170×244×39	C	57,-	963-127	78,-
EMB 5.2K1	5200	1	1	± 3	170×244×39	C	60,-	963-128	94,-
EMB 5.2K5	5200	5	5	± 10	170×244×39	C	55,-	963-128	94,-



School balance with integrated density determination function

Features

- Density determination made easy! Thanks to the self-explanatory, graphic-assisted control panel, the density of solids and liquids can be determined in seconds, making them ideal for use in schools and universities
- Self-explanatory graphic control panel, the workings steps can be understood immediately, even without operating instructions
 - no learning time = reduces costs
 - ideal for untrained users
 - visualised process avoids operating errors
- The 4 steps are carried out from left to right:
 - 1 Tare the balance by pressing the [TARE] key
 - 2 Select density determination mode (solids/liquids)
 - 3 Weighing of samples/plummets in air
 - 4 Weighing of samples/plummets in liquid. The density will be shown on the display right away
- Particularly flat design
- Hook for underfloor weighing standard
- Ready for use: Batteries included, 9 V block, operating time up to 12 h, AUTO-OFF function to preserve the battery
- **Note:** Balance and appropriate set for density determination should be ordered at the same time, see accessories

Technical data

- Large LCD display, digit height 15 mm
- Dimensions weighing surface, plastic
 - A \varnothing 82 mm
 - B \varnothing 150 mm, see larger picture
- Overall dimensions WxDxH 175x245x54 mm
- Net weight approx. 0,85 kg
- Permissible ambient temperature 5 °C/35 °C
- Now also with carat weighing unit:
EMB 200-3V: 1000 ct/0,005 ct

Accessories

KERN EMB 200-3V:

- 5 Ancillary kit for density determination of liquids and solids with density > 1. Scope of supplies: Bridge for holding the beaker (\varnothing 102 mm), hook (H 139 mm), suitable for models with weighing plate size A, KERN YDB-04, € 24,-
- 6 Set for density determination of liquids and solids with density \leq/\geq 1. Scope of delivery: Weighing plate, beaker (Hx \varnothing 71x51 mm), sample holder, plummet, KERN YDB-01, € 215,-
- DAkkS-Calibration certificate for the plummet (20 g), KERN 962-335V, € 143,-

KERN EMB 2000-2V:

- 7 Set for density determination of liquids and solids with density \leq/\geq 1. Scope of delivery: Weighing plate, beaker (Hx \varnothing 135x100 mm), sample holder, plummet KERN YDB-02, € 330,-
- DAkkS-Calibration certificate for the plummet (200 g), KERN 962-338V, € 141,-

STANDARD



OPTION



Model	Weighing capacity [Max] g	Readability [d] g	Reproducibility g	Linearity g	Weighing plate	Price excl. of VAT ex works €	Option	
							DAkkS KERN	DAkkS Calibr. Certificate €
KERN EMB 200-3V	200	0,001	0,002	\pm 0,005	A	250,-	963-127	78,-
EMB 2000-2V	2000	0,01	0,02	\pm 0,05	B	250,-	963-127	78,-



Entry level model in the low-cost range with large weighing plate

Features

- Especially suitable for use in schools and universities, for example for biology, chemistry, physics
- Large, shock proof weighing plate made of plastic, with conductive lacquer
- Particularly flat design
- Ergonomically optimised key pad with large keys and a high-contrast LCD display
- Secure and non-slip positioning through rubber feet
- Adjusting program CAL for quick setting of the balance accuracy, external test weights at an additional price, see Test weights
- **1** Draught shield standard for models with weighing plate size **A**, weighing space W×D×H 145×145×65 mm
- Suitable for common school LIMS systems

Technical data

- LCD display, digit height 25 mm
- Dimensions of weighing surface, **A** Ø 105 mm, **B** W×D 175×190 mm, see larger picture
- Weighing plate material **A** plastic, with conductive lacquer, **B** plastic
- Overall dimensions W×D×H 200×280×63 mm (without draught shield)
- Optional battery operation, 9 V block not included in scope of delivery, operating time up to 40 h
- External mains adapter standard
- Net weight approx. 1,4 kg
- Permissible ambient temperature 5 °C/35 °C

Accessories

- **2** Stainless steel weighing plate, only for models with weighing plate size **B**, KERN EMS-A01, € 30,-

STANDARD: CAL EXT, PCS, RECIPE, PERCENT, UNIT, BATT, MULTI, DMS, 1 DAY, DAKKS +3 DAYS

OPTION: DAKKS +3 DAYS

Model	Weighing capacity [Max] g	Readability [d] g	Reproducibility g	Linearity g	Weighing plate	Quality code	Price excl. of VAT ex works €	Option	
								DAKKS KERN	€
KERN EMS 300-3	300	0,001	0,002	± 0,005	A	AA	260,-	963-127	78,-
EMS 3000-2	3000	0,01	0,02	± 0,05	B	BA	240,-	963-127	78,-
EMS 6K0.1	6000	0,1	0,1	± 0,3	B	AA	160,-	963-128	94,-
EMS 12K0.1	12000	0,1	0,1	± 0,3	B	AA	205,-	963-128	94,-
EMS 6K1	6000	1	1	± 3	B	AA	80,-	963-128	94,-
EMS 12K1	12000	1	1	± 3	B	AA	85,-	963-128	94,-

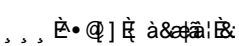



The compact all-round model with robust stainless steel weighing plate for us in laboratories, industries and for teaching

Features

- Thanks to its compact, robust design, its bright display and high precision, this range is ideal for use in laboratories, quality control, production as well in schools and universities for teaching e.g. biology, chemistry and physics
- Large, shock proof weighing plate made from stainless steel, can be removed and therefore is hygienic and easy to clean
- **1** Particularly flat design
- Ergonomically-optimised key pad with large keys and a high-contrast LCD screen
- **2** Secure and non-slip positioning through rubber feet
- Level indicator and levelling feet for precise levelling of the scale, fitted as standard, to give the most accurate weighing result
- Adjusting program CAL for quick setting of the balance accuracy using an external test weight

Technical data

- Backlit LCD display, digit height 22 mm
- Dimensions of weighing surface, stainless steel
 - A** Ø 105 mm
 - B** 120×120×7 mm, see larger picture
- Overall dimensions W×D×H 225×160×50 mm (without draught shield)
- Optional battery operation, 2×1.5 V AA not included in scope of delivery, operating time up to 70 h
- External mains adapter standard
- Net weight 0,50 kg
- Permissible ambient temperature 5 °C/40 °C

STANDARD

CAL EXT PCS UNIT BATT MULTI DMS 1 DAY

OPTION

DAKKS +3 DAYS

Model	Weighing capacity [Max] g	Readability [d] g	Reproducibility g	Linearity g	Weighing plate	Price excl. of VAT ex works €	Option	
							DAKKS KERN	DAKKS Calibr. Certificate €
EHA 500-2	500	0,01	0,03	± 0,02	A	90,-	963-127	78,-
EHA 500-1	500	0,1	0,3	± 0,2	A	65,-	963-127	78,-
EHA 1000-1	1000	0,1	0,3	± 0,2	B	65,-	963-127	78,-
EHA 3000-1	3000	0,1	0,3	± 0,3	B	90,-	963-127	78,-
EHA 3000-0	3000	1	3	± 2	B	65,-	963-127	78,-

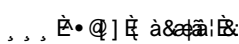



03





Precision balances

Here you'll find a complete summary of the KERN laboratory scales series and their positioning within the precision scales segment on the basis of application, price-performance ratio and functional volume

PREMIUM LABORATORY BALANCES

				★★★★
				★★
				★





STANDARD LABORATORY BALANCES

					★★★★
					★★
					★

BASIC LABORATORY BALANCES

						★★★★
						★★
						★

SCHOOL BALANCES

						★★★★
						★★
						★
	► Page 15	► Page 16	► P. 17	► P. 18	► P. 19	



from €
340,-

KERN EWJ

Page 29

- Easy to use
- Automatic internal adjustment
- Capacity display
- USB interface (not EWJ-SM)

Precision balances

KERN school balances

are entry-level devices in the field of laboratory balances, and they cover basic applications. They feature simple operation and the very best price/performance ratio. In addition they usually can be stacked and can also be operated by battery, as an alternative to mains power, which means that they have the flexibility to be used in different locations.

See *school balances*

KERN Basic laboratory balances

are used in laboratory applications mostly as single-user balances for sample preparation, etc. They are fitted with all useful laboratory functions which will support the user in a helpful way. With their strain gauge measuring principle, they are used anywhere where individual weighings are carried out, such as, for example, checkweighing. These devices are often connected to printers or local PCs using the standard, integrated RS-232 data interface.

KERN Basic standard laboratory balances

offer you all the tools you would need for effective and accurate work in your laboratory environment. All important laboratory functions such as a recipe weighing function or data interfaces are on board at all times. But above all, the high-quality measuring principles of these balances such as force compensation or tuning fork measuring principle,

allow them to be used in dosing procedures with very small weight changes and rapid display. In addition these balances are often fitted with automatic internal adjustment, which permits calibrated operation and means the balance can be used in any location.

KERN premium laboratory balances

are right at the top of the precision balance segment. The numerous equipment features of the standard balances are complemented by high-quality materials with robust, sturdy construction, high-quality, high-performance weighing systems, optimised operating sequences, speed benefits and in some cases, the most modern touchscreen technology (KERN EasyTouch). With its touchscreen technology (KERN EasyTouch) a premium laboratory balance its users in their typical procedures. In this way these scales can be operated more efficiently and quickly than devices from other quality classes. In particular these balances are used in demanding laboratory applications and anywhere where the environmental conditions are not ideal because of vibrations or other interference, but where, naturally, the balance is expected to provide accurate weighing results. Another field of application for these balances is the pharmaceutical industry, which is subject to particularly demanding requirements and authorities such as, for example, the FDA (Food and Drug Administration).

In order to make it easier for you to make the right choice of KERN balance, we have included a quality code for each model, which is made up of two quality features and will give you technical data and pictograms in addition to the product features. This will help you to make the decision on the perfect balance for your application:

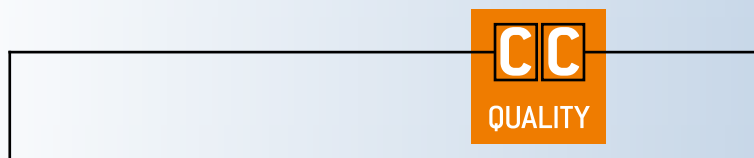

The stability quality feature

How quickly and sensitively weighing results are displayed? This quality feature on the basis of the information on the housing material and total weight of the balance, the stability quality feature gives you an indication of the types of application for which the balance is particularly well-suited. Due to their low weight, materials such as plastic allows structures which are particularly advantageous for mobile applications. The appeal of models which are used to process high-quality, heavy material, such as, for example, aluminium casting or steel, is their durability and robustness and the fact that they are less susceptible to vibrations. A high level of stability allows rapid, repeatable weighing results.









Categorisation in **A, B, C, best value: C**

The dosing level quality feature

comes from the values for reaction time, stabilisation time and behaviour during long-term weighing procedures. These parameters give information about how well-suited a model is for fine dosing, amongst other functions. In particular with these dosing procedures, the balance performs a balancing act between filtering out disruptive environmental influences, such as, for example, vibrations on the one hand, and the highest level of accuracy as well as rapid display when weighing goods right down to the smallest division [d] on the other hand. In addition this value is printed, whether drift effects influence the continuous measurement in long-term trials. Categorisation into **A, B, C, best value: C**

If you have further questions on the subject of "Which balance will be best for my application?", then please ask your personal KERN KERN segment specialists who will be happy to help you.

Quick-Finder Precision balances

Readability [d] g	Weighing capacity [Max] g	Model KERN	Price excl. of VAT ex works €	Page	Quality code QUALITY										For an explanation on the pictos, see front flap									
0,001	60	440-21A	350,-	26	AA	1			●	●	●		●	○										
0,001	100	PCB 100-3	265,-	25	AA	1			●	●	●		●	○										
0,001	120	PFB 120-3	280,-	27	AA	1			●	●	●													
0,001	120	KB 120-3N	290,-	28	AA	1			●	●	●			○										
0,001	200	PFB 200-3	295,-	27	AA	1			●	●	●													
0,001	220	EW 220-3NM	620,-	33	AB	1			●	●	●	●		○										
0,001	220	EG 220-3NM	760,-	33	BB	1	○	●		●	●	●		○										
0,001	240	KB 240-3N	300,-	28	AA	1			●	●	●			○										
0,001	240	572-30	520,-	30	BA	1			●	●	●			○										
0,001	250	PCD 250-3	305,-	24	AA	1			●	●	●		●	○										
0,001	250	PCB 250-3	290,-	25	AA	1			●	●	●		●	○										
0,001	300	PFB 300-3	320,-	27	BA	1			●	●	●													
0,001	300	EWJ 300-3	450,-	29	BA	1		●		●	●													
0,001	300	EWJ 300-3H	490,-	29	BA	1		●		●	●													
0,001	300	572-31	530,-	30	BA	1			●	●	●			○										
0,001	350	PCD 300-3	350,-	24	AA	1			●	●	●		●	○										
0,001	350	PCB 350-3	300,-	25	AA	1			●	●	●		●	○										
0,001	360	KB 360-3N	310,-	28	AA	1			●	●	●			○										
0,001	420	572-32	540,-	30	BA	1			●	●	●			○										
0,001	420	PLS 420-3F	590,-	31	BA	1			●	●	●	●												
0,001	420	PLJ 420-3F	700,-	31	BA	1		●	●	●	●	●												
0,001	420	EW 420-3NM	690,-	33	AB	1			●	●	●	●		○										
0,001	420	EG 420-3NM	830,-	33	BB	1	○	●		●	●	●		○										
0,001	620	PNS 600-3	620,-	32	BB	1			●	●	●													
0,001	620	PNJ 600-3M	740,-	32	BB	1	○	●		●	●	●												
0,001	620	EW 620-3NM	770,-	33	AB	1			●	●	●	●		○										
0,001	620	EG 620-3NM	930,-	33	BB	1	○	●		●	●	●		○										
0,001	620	PBS 620-3M	1370,-	34	BC	1			●	●	●	●												
0,001	620	PBJ 620-3M	1610,-	34	BC	1	○	●		●	●	●												
0,001	620	PES 620-3M	1220,-	35	BB	1			●	●	●	●		○										
0,001	620	PEJ 620-3M	1480,-	35	BB	1	○			●	●	●	●		○									
0,001	720	PLS 720-3A	840,-	31	BC	1			●	●	●	●												
0,001	720	PLJ 720-3A	980,-	31	BC	1		●		●	●	●												
0,001	720	PLJ 720-3AM	980,-	31	BC	1	○	●		●	●	●												
0,001	1200	PLS 1200-3A	880,-	31	BC	1			●	●	●	●												
0,001	1200	PLJ 1200-3A	1000,-	31	BC	1		●		●	●	●												
0,001	2100	PLJ 2000-3A	1650,-	31	CC	1		●		●	●	●												
0,01	200	PCB 200-2	230,-	25	AA	1			●	●	●		●	○										
0,01	200	440-33N	290,-	26	AA	1			●	●	●		●	○										
0,01	400	440-35N	330,-	26	AA	1			●	●	●		●	○										
0,01	600	440-35A	365,-	26	AA	1			●	●	●		●	○										
0,01	600	PFB 600-2	245,-	27	BA	1			●	●	●													
0,01	600	EWJ 600-2SM	350,-	29	BA	1	○	●		●	●	●		○										
0,01	600	EWJ 600-2M	360,-	29	BA	1	○	●		●	●	●		○										
0,01	650	KB 650-2N	270,-	28	BA	1			●	●	●			○										
0,01	650	573-34	530,-	30	BA	1			●	●	●			○										
0,01	820	EW 820-2NM	540,-	33	BB	1			●	●	●	●		○										
0,01	1000	PCB 1000-2	280,-	25	AA	1			●	●	●		●	○										
0,01	1200	PFB 1200-2	245,-	27	AA	1			●	●	●													
0,01	1200	KB 1200-2N	280,-	28	BA	1			●	●	●			○										
0,01	1600	572-33	490,-	30	BA	1			●	●	●			○										
0,01	2000	PFB 2000-2	260,-	27	BA	1			●	●	●													
0,01	2000	KB 2000-2N	280,-	28	BA	1			●	●	●			○										
0,01	2200	EW 2200-2NM	660,-	33	BB	1			●	●	●	●		○										
0,01	2200	EG 2200-2NM	800,-	33	BB	1	○	●		●	●	●		○										
0,01	2200	PES 2200-2M	840,-	35	BB	1			●	●	●	●		○										
0,01	2200	PEJ 2200-2M	1060,-	35	CB	1	○	●		●	●	●		○										
0,01	2400	KB 2400-2N	290,-	28	BA	1			●	●	●			○										
0,01	2400	572-35	500,-	30	BA	1			●	●	●			○										
0,01	2500	PCD 2500-2	295,-	24	BA	1			●	●	●		●	○										
0,01	2500	PCB 2500-2	290,-	25	BA	1			●	●	●		●	○										
0,01	3000	PFB 3000-2	285,-	27	AA	1			●	●	●													
0,01	3000	EWJ 3000-2	430,-	29	BA	1		●		●	●													
0,01	3000	572-37	510,-	30	BA	1			●	●	●			○										
0,01	3200	PNS 3000-2	580,-	32	BB	1			●	●	●													
0,01	3200	PNJ 3000-2M	705,-	32	BB	1	○	●		●	●	●												
0,01	3500	PCD 3000-2	350,-	24	BA	1			●	●	●		●	○										
0,01	3500	PCB 3500-2	300,-	25	AA	1			●	●	●		●	○										
0,01	3600	KB 3600-2N	310,-	28	BA	1			●	●	●			○										
0,01	4200	572-39	520,-	30	BA	1			●	●	●			○										
0,01	4200	PLS 4200-2F	590,-	31	BA	1			●	●	●	●												

● = standard

○ = option

Quick-Finder Precision balances

Readability [d] g	Weighing capacity [Max] g	Model KERN	Price excl. of VAT ex works €	Page	Quality code QUALITY										
						For an explanation on the pictos, see front flap									
0,01	4200	PLJ 4200-2F	690,-	31	BA	1		●		●	●	●			
0,01	4200	EW 4200-2NM	760,-	33	BB	1			●	●	●	●		○	
0,01	4200	EG 4200-2NM	880,-	33	BB	1	○	●		●	●	●		○	
0,01	4200	PBS 4200-2M	1160,-	34	BC	1			●	●	●	●			
0,01	4200	PBJ 4200-2M	1430,-	34	BC	1	○	●		●	●	●			
0,01	4200	PES 4200-2M	1000,-	35	BB	1			●	●	●	●		○	
0,01	4200	PEJ 4200-2M	1230,-	35	CB	1	○	●		●	●	●		○	
0,01	6200	PLS 6200-2A	860,-	31	BC	1			●	●	●	●			
0,01	6200	PLJ 6200-2A	980,-	31	CC	1			●	●	●	●			
0,01	6200	PLJ 6200-2AM	980,-	31	CC	1	○	●		●	●	●			
0,01	6200	EW 6200-2NM	810,-	33	BB	1				●	●	●		○	
0,01	6200	PBS 6200-2M	1390,-	34	BC	1			●	●	●	●			
0,01	6200	PBJ 6200-2M	1730,-	34	CC	1	○		●	●	●	●			
0,01	6200	PES 6200-2M	1240,-	35	BB	1			●	●	●	●		○	
0,01	8200	PLS 8000-2A	1040,-	31	BC	1			●	●	●	●			
0,05	6000	PFB 6000-2	250,-	27	BA	1			●	●	●	●			
0,05	10000	KB 10K0.05N	280,-	28	BA	1			●	●	●	●		○	
0,05	12000	572-45	500,-	30	BA	1			●	●	●	●		○	
0,05	20000	572-55	530,-	30	BA	1			●	●	●	●		○	
0,1	400	440-43N	215,-	26	AA	1			●	●	●	●	●	○	
0,1	1000	PCB 1000-1	185,-	25	AA	1			●	●	●	●	●	○	
0,1	1000	440-45N	245,-	26	AA	1			●	●	●	●	●	○	
0,1	2000	PCB 2000-1	215,-	25	AA	1			●	●	●	●	●	○	
0,1	2000	440-47N	270,-	26	AA	1			●	●	●	●	●	○	
0,1	4000	440-49N	330,-	26	AA	1			●	●	●	●	●	○	
0,1	6000	PCD 6K-4	260,-	24	BA	1			●	●	●	●	●	○	
0,1	6000	PCB 6000-1	240,-	25	BA	1			●	●	●	●	●	○	
0,1	6000	440-49A	365,-	26	AA	1			●	●	●	●	●	○	
0,1	6000	PFB 6000-1	225,-	27	BA	1			●	●	●	●	●		
0,1	6000	EWJ 6000-1SM	340,-	29	BA	1	○	●		●	●	●		○	
0,1	6000	EWJ 6000-1M	350,-	29	BA	1	○	●		●	●	●		○	
0,1	6500	KB 6500-1N	260,-	28	BA	1			●	●	●	●		○	
0,1	6500	573-46	530,-	30	BA	1			●	●	●	●		○	
0,1	8200	PBJ 8200-1M	1420,-	34	BC	1	○	●		●	●	●	●		
0,1	10000	PCD 10K0.1	240,-	24	BA	1			●	●	●	●	●	○	
0,1	10000	PCB 10000-1	245,-	25	BA	1			●	●	●	●	●	○	
0,1	10000	KB 10000-1N	270,-	28	BA	1			●	●	●	●	●	○	
0,1	10000	572-43	490,-	30	BA	1			●	●	●	●		○	
0,1	12000	PNS 12000-1	570,-	32	BB	1			●	●	●	●			
0,1	12000	PNJ 12000-1M	705,-	32	BB	1	○	●		●	●	●			
0,1	12000	EW 12000-1NM	630,-	33	BB	1			●	●	●	●	●	○	
0,1	15000	PES 15000-1M	1190,-	35	BB	1			●	●	●	●	●	○	
0,1	16000	572-49	500,-	30	BA	1			●	●	●	●	●	○	
0,1	20000	PLS 20000-1F	570,-	31	BA	1			●	●	●	●	●		
0,1	24000	572-57	500,-	30	BA	1			●	●	●	●	●	○	
0,1	31000	PES 31000-1M	2090,-	35	CB	1			●	●	●	●	●	○	
1	4000	440-51N	160,-	26	AA	1			●	●	●	●	●	○	
1	6000	PCB 6000-0	185,-	25	BA	1			●	●	●	●	●	○	
1	6000	440-53N	210,-	26	AA	1			●	●	●	●	●	○	
1	10000	PCD 10K-3	190,-	24	BA	1			●	●	●	●	●	○	

● = standard

○ = option



03

High-resolution precision balance with removable display for maximum flexibility

Features

- Laboratory balance with separate platform: Ideal when working in the glove bag or fume cupboard. Particularly practical for weighing toxic, volatile or contaminated substances
- PRE-TARE function for manual subtraction of a known container weight, useful for checking fill-levels
- Freely programmable weighing unit, e.g. display direct in special units such as length of thread g/m, paper weight g/m², or similar
- Level indicator and levelling feet for precise levelling of the scale, fitted as standard, to give the most accurate weighing result
- **1** Draught shield standard for models with weighing plate size **A**, weighing space W×D×H 146×146×80 mm
- Protective working cover included with delivery

Technical data

- Large backlit LCD display, digit height 21 mm
- Dimensions weighing surface
 - A** Ø 105 mm
 - B** W×D , see larger picture
- Weighing plate material
 - A** plastic, with conductive lacquer
 - B** Stainless Steel
- Dimensions of display device W×D×H 165×280×141 mm
- Optional battery operation, 9 V block not included in scope of delivery, operating time up to 12 h, AUTO-OFF function to preserve the battery
- Overall dimensions W×D×H, without draught shield 165×280×75 mm
- Cable length of display device approx. 1,2 m
- Net weight approx. 1,2 kg
- Permissible ambient temperature 5 °C/35 °C

Accessories

- Protective working cover over the display device, scope of delivery: 5 items, KERN PCD-A05S05, **€ 50,-**
- **2** Stand to elevate display device, height of stand approx. 250 mm, KERN PCD-A03, **€ 50,-**
- Internal rechargeable battery pack, operating time up to 24 h without backlight, charging time approx. 10 h, KERN PCD-A04, **€ 50,-**
- **3** Foot switch, ideal when the application requires two free hands. TARE or PRINT function can be selected. Scope of delivery: foot switch, junction box, connection cable. For the PRINT function you will need the RS-232 interface cable, KERN YKF-01, **€ 85,-**
- RS-232/Ethernet adapter for connection to an IP-based Ethernet network, KERN YKI-01, **€ 290,-**
- Individual header data: the free software can be used to print 4 header lines on the printout when using printers 911-013, YKN-01, YKB-01N and YKE-01 (in combination with YKI-02)
- Further details, plenty of further accessories and suitable printers see *Accessories*

STANDARD



OPTION



Model	Weighing capacity [Max] g	Readability [d] g	Reproducibility g	Linearity g	Weighing plate	Quality code	Price excl. of VAT ex works €	Option	
								DAkKS KERN	DAkKS Certificate €
KERN PCD 250-3	250	0,001	0,002	± 0,005	A	AA	305,-	963-127	78,-
KERN PCD 300-3	350	0,001	0,002	± 0,005	A	AA	350,-	963-127	78,-
KERN PCD 2500-2	2500	0,01	0,02	± 0,05	B	BA	295,-	963-127	78,-
KERN PCD 3000-2	3500	0,01	0,02	± 0,05	B	BA	350,-	963-127	78,-
KERN PCD 6K-4	6000	0,1	0,1	± 0,3	B	BA	260,-	963-128	94,-
KERN PCD 10K0.1	10000	0,1	0,1	± 0,3	B	BA	240,-	963-128	94,-
KERN PCD 10K-3	10000	1	1	± 3	B	BA	190,-	963-128	94,-



The standard in the laboratory

Features

- PRE-TARE function for manual subtraction of a known container weight, useful for checking fill-levels
- Freely programmable weighing unit, e.g. display direct in special units such as length of thread g/m, paper weight g/m², or similar
- With the recipe function you can weigh the different ingredients of a mixture. As a check, you can also call up the total weight of all the ingredients
- Plus/minus weighing procedures
- Ring-shaped draught shield standard, only for models with weighing plate size **A**, weighing space $\varnothing \times H$ 90×40 mm
- Protective working cover included with delivery

Technical data

- Backlit LCD display, digit height 15 mm
- Dimensions of weighing surface
 - A** \varnothing 81 mm
 - B** \varnothing 105 mm
 - C** W×D 130×130 mm
 - D** W×D 150×170 mm, see larger picture
- Weighing plate material
 - A** plastic, with conductive lacquer
 - B, C, D** Stainless Steel
- Overall dimensions W×D×H 163×245×79 mm (without draught shield)
- Optional battery operation, 9 V block not included in scope of delivery, operating time up to 20 h, AUTO-OFF function to preserve the battery
- Permissible ambient temperature 5 °C/35 °C

Accessories

- Protective working cover, scope of delivery: 5 items, for models with weighing plate size
 - A** KERN PCB-A02S05, € 40,-
 - B** KERN PCB-A03S05, € 40,-
 - C** KERN PCB-A04S05, € 40,-
 - D** KERN PCB-A05S05, € 40,-
- Internal rechargeable battery pack, operating time up to 48 h without backlight, charging time approx. 8 h, KERN PCB-A01, € 75,-
- RS-232/Ethernet adapter for connection to an IP-based Ethernet network, KERN YKI-01, € 290,-
- Balance Connection Software, KERN SCD-4.0, € 150,-
- Individual header data: the free software SHM-01 can be used to print 4 header lines on the printout when using printers 911-013, YKN-01, YKB-01N, YKE-01 and YKC-01 (in combination with YKI-02)
- Further details, plenty of further accessories and suitable printers see *Accessories*

STANDARD



OPTION



Model	Weighing capacity [Max] g	Readability [d] g	Reproducibility g	Linearity g	Weighing plate	Quality code	Price excl. of VAT ex works €	Option	
								DAKKS KERN	Calibr. Certificate €
KERN PCB 100-3	100	0,001	0,001	± 0,003	A	AA	265,-	963-127	78,-
PCB 250-3	250	0,001	0,001	± 0,005	A	AA	290,-	963-127	78,-
PCB 350-3	350	0,001	0,002	± 0,005	A	AA	300,-	963-127	78,-
PCB 200-2	200	0,01	0,01	± 0,02	B	AA	230,-	963-127	78,-
PCB 1000-2	1000	0,01	0,01	± 0,03	C	AA	280,-	963-127	78,-
PCB 2500-2	2500	0,01	0,01	± 0,05	C	BA	290,-	963-127	78,-
PCB 3500-2	3500	0,01	0,02	± 0,05	C	AA	300,-	963-127	78,-
PCB 1000-1	1000	0,1	0,1	± 0,2	C	AA	185,-	963-127	78,-
PCB 2000-1	2000	0,1	0,1	± 0,2	C	AA	215,-	963-127	78,-
PCB 6000-1	6000	0,1	0,1	± 0,3	D	BA	240,-	963-128	94,-
PCB 10000-1	10000	0,1	0,1	± 0,3	D	BA	245,-	963-128	94,-
PCB 6000-0	6000	1	1	± 2	D	BA	185,-	963-128	94,-



03

The classic balance in the laboratory

Features

- Compact size, practical for small spaces
- Percentage determination: makes it possible to store a given weight value (100 %) and to determine deviations from this target value
- Ring-shaped draught shield standard, only for models with weighing plate size **A**, weighing space $\phi \times H$ 90×40 mm
- Protective working cover included with delivery

Technical data

- Backlit LCD display, digit height 15 mm
- Dimensions weighing surface
 - A** ϕ 81 mm
 - B** ϕ 105 mm
 - C** W×D 130×130 mm
 - D** W×D 150×170 mm, see larger picture
- Weighing plate material
 - A** plastic, with conductive lacquer
 - B, C, D** Stainless Steel
- Overall dimensions (without draught shield) W×D×H 165×230×80 mm
- Optional battery operation, 9 V block, standard, operating time up to 20 h, AUTO-OFF function to preserve the battery
- Net weight approx. 0,95 kg
- Permissible ambient temperature 5 °C/35 °C

Accessories

- Protective working cover, scope of delivery: 5 items, for models with weighing plate size
 - A** KERN 440-210-002S05, € 40,-
 - B** KERN 440-330-002S05, € 40,-
 - C** KERN 440-450-002S05, € 40,-
 - D** KERN 440-530-002S05, € 40,-
- Internal rechargeable battery pack, operating time up to 20 h, without backlight, charging time approx. 10 h, KERN FCB-A01, € 50,-
- Hook for underfloor weighing, KERN 440-A01, € 25,-
- RS-232/Ethernet adapter for connection to an IP-based Ethernet network, KERN YKI-01, € 290,-
- Individual header data: the free software SHM-01 can be used to print 4 header lines on the printout when using printers 911-013, YKN-01, YKB-01N, YKE-01 and YKC-01 (in combination with YKI-02)
- Further details, plenty of further accessories and suitable printers see *Accessories*

STANDARD



OPTION



Model	Weighing capacity [Max] g	Readability [d] g	Reproducibility g	Linearity g	Weighing plate	Price excl. of VAT ex works €	Option	
							DAKKS KERN	Calibr. Certificate €
440-21A	60	0,001	0,001	± 0,003	A	350,-	963-127	78,-
440-33N	200	0,01	0,01	± 0,02	B	290,-	963-127	78,-
440-35N	400	0,01	0,01	± 0,03	B	330,-	963-127	78,-
440-35A	600	0,01	0,01	± 0,03	B	365,-	963-127	78,-
440-43N	400	0,1	0,1	± 0,2	C	215,-	963-127	78,-
440-45N	1000	0,1	0,1	± 0,2	C	245,-	963-127	78,-
440-47N	2000	0,1	0,1	± 0,2	C	270,-	963-127	78,-
440-49N	4000	0,1	0,1	± 0,3	D	330,-	963-127	78,-
440-49A	6000	0,1	0,1	± 0,3	D	365,-	963-128	94,-
440-51N	4000	1	1	± 2	D	160,-	963-127	78,-
440-53N	6000	1	1	± 2	D	210,-	963-128	94,-

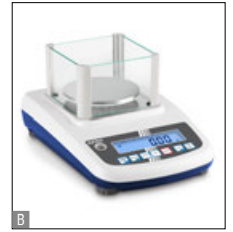

03

Quick-display precision balance with user-friendly concept of operation mode – now with larger housing for more stability

Features

- Easy to use: All primary functions have their own key on the keypad
- Compact size, practical for small spaces
- Capacity display: A bargraph display lights up to show how much of the weighing range is still available
- Level indicator and levelling feet for precise levelling of the scale, fitted as standard, to give the most accurate weighing result
- Draught shield standard for models with weighing plate size **A** and **B**, weighing space W×D×H 158×143×64 mm

Technical data

- Backlit LCD display, digit height 15 mm
- Dimensions weighing surface, Stainless Steel
 - A** ø 80 mm
 - B** ø 120 mm
 - C** W×D 155×145 mm, see larger picture
- Overall dimensions W×D×H 210×315×90 mm (without draught shield)
- Net weight approx. 2,0 kg
- Permissible ambient temperature 15 °C/30 °C

Accessories

- Protective working cover, scope of delivery: 5 items, KERN PFB-A12S05, **€ 40,-**
- **1** Separate second display, ideal for training and demonstration purposes in laboratories or industry, not permitted for direct sales to the public, KERN PFB-A08, **€ 115,-**
- Bluetooth data interface for wireless data transfer to PC or tablets, must be ordered at purchase
 - Bluetooth 2.0: KERN PFB-A10, **€ 95,-**
 - Bluetooth 4.0: KERN PFB-A11, **€ 125,-**
- Further details, plenty of further accessories and suitable printers see *Accessories*

STANDARD: CAL EXT, RS 232, KCP, GLP, PCS, RECIPE, PERCENT, MULTI, DMS, 1 DAY

OPTION: DAKKS +3 DAYS

FACTORY: BT 2.0 (PFB-A10), BT 4.0 (PFB-A11)

Model	Weighing capacity [Max] g	Readability [d] g	Reproducibility g	Linearity g	Weighing plate	Price excl. of VAT ex works €	Option	
							DAKKS KERN	DAKKS Calibr. Certificate €
PFB 120-3	120	0,001	0,001	± 0,003	A	280,-	963-127	78,-
PFB 200-3	200	0,001	0,002	± 0,005	A	295,-	963-127	78,-
PFB 300-3	300	0,001	0,002	± 0,005	A	320,-	963-127	78,-
PFB 600-2	600	0,01	0,01	± 0,03	B	245,-	963-127	78,-
PFB 1200-2	1200	0,01	0,01	± 0,03	B	245,-	963-127	78,-
PFB 2000-2	2000	0,01	0,02	± 0,05	B	260,-	963-127	78,-
PFB 3000-2	3000	0,01	0,02	± 0,05	B	285,-	963-127	78,-
PFB 6000-2	6000	0,05	0,05	± 0,15	C	250,-	963-128	94,-
PFB 6000-1	6000	0,1	0,1	± 0,3	C	225,-	963-128	94,-

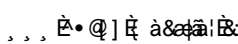



03

Compact precision balance with large weighing capacity

Features

- Thanks to the many typical laboratory functions, such as, for example, recipe function, percentage determination, GLP record keeping, combined with the high level of precision, the KERN KB-N is a reliable partner for day-to-day work in the laboratory
- User guidance step by step on display by Yes/No dialogue
- Freely programmable weighing unit, e.g. display direct in special units such as length of thread g/m, paper weight g/m², or similar
- Ring-shaped draught shield standard, only for models with weighing plate size **A**, weighing space $\varnothing \times H$ 90×40 mm
- Model with resolution > 240,000 Pt.: Level indicator to level the balance precisely
- Protective working cover included with delivery

Technical data

- Backlit LCD display, digit height 9 mm
- Dimensions of weighing surface
 - A** \varnothing 81 mm, plastic, with conductive lacquer
 - B** W×D 130×130 mm, stainless steel
 - C** W×D 150×170 mm, stainless steel, see larger picture
- Overall dimensions W×D×H 167×250×85 mm (without draught shield)
- Net weight 1,00 kg
- Permissible ambient temperature 10 °C/40 °C

Accessories

- Protective working cover, scope of delivery: 5 items, for models with weighing plate size
 - A** KERN PCB-A02S05, € 40,-
 - B** KERN PCB-A04S05, € 40,-
 - C** KERN PCB-A05S05, € 40,-
- Internal rechargeable battery pack, operating time up to 30 h without backlight, charging time approx. 10 h, KERN KB-A01N, € 50,-
- **1** Rechargeable battery pack external, operating time up to 30 h without backlight, charging time approx. 10 h, KERN KS-A01, € 160,-
- Further details, plenty of further accessories and suitable printers see *Accessories*

STANDARD

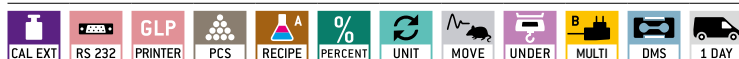

OPTION



Model	Weighing capacity [Max] g	Readability [d] g	Reproducibility g	Linearity g	Weighing plate	Quality code	Price excl. of VAT ex works €	Option	
								DAKkS Calibr. Certificate	€
KERN KB 120-3N	120	0,001	0,001	± 0,003	A	AA	290,-	963-127	78,-
KB 240-3N	240	0,001	0,001	± 0,003	A	AA	300,-	963-127	78,-
KB 360-3N	360	0,001	0,002	± 0,005	A	AA	310,-	963-127	78,-
KB 650-2N	650	0,01	0,01	± 0,03	B	BA	270,-	963-127	78,-
KB 1200-2N	1200	0,01	0,01	± 0,03	B	BA	280,-	963-127	78,-
KB 2000-2N	2000	0,01	0,01	± 0,03	B	BA	280,-	963-127	78,-
KB 2400-2N	2400	0,01	0,01	± 0,03	B	BA	290,-	963-127	78,-
KB 3600-2N	3600	0,01	0,02	± 0,05	B	BA	310,-	963-127	78,-
KB 10K0.05N	10000	0,05	0,05	± 0,15	C	BA	280,-	963-128	94,-
KB 6500-1N	6500	0,1	0,1	± 0,3	C	BA	260,-	963-128	94,-
KB 10000-1N	10000	0,1	0,1	± 0,3	C	BA	270,-	963-128	94,-

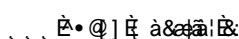



03

High-quality precision balance with automatic internal adjustment, also with EC type approval [M]

Features

- Easy to use: All primary functions have their own key on the keypad
- Automatic internal adjustment, time-controlled every 2 h, guarantees high degree of accuracy and makes the balance independent of its location
- Capacity display: A bargraph display lights up to show how much of the weighing range is still available
- KERN EWJ-H/-M: USB data interface for transferring weighing data to the PC, printer etc. Can only be used in combination with KERN KERN DBS-A02 accessories
- KERN EWJ-SM: Cost-effective variant without data interfaces
- Draught shield standard on models with [Max] 600 g, weighing space W×D×H 134×128×80 mm

- **1** KERN EWJ 300-3H: Large glass draught shield with 3 sliding doors for easy access to the items being weighed. Weighing space W×D×H 155×175×217 mm
- Protective working cover included with delivery

Technical data

- Large backlit LCD display, digit height 16,5 mm
- Dimensions weighing surface
 - A** Ø 80 mm
 - B** Ø 120 mm, see larger picture
 - C** W×D 155×145 mm
- Overall dimensions W×D×H
 - 220×315×90 mm (without draught shield)
 - 220×340×321 mm (incl. draught shield)
- Permissible ambient temperature
 - KERN EWJ: 15 °C/35 °C
 - KERN EWJ-M: 15 °C/30 °C

Accessories

- Protective working cover, scope of delivery: 5 items, KERN EWJ-A04S05, **€ 40,-**
- Internal rechargeable battery pack, operating time up to 20 h without backlight, charging time approx. 12 h, KERN KFB-A01, **€ 35,-**
- KERN EWJ-H/-M: Scope of delivery: USB cable, driver, Software BalanceConnection, USB interface kit for bi-directional data exchange between balance/moisture analyzer and computer. KERN DBS-A02, **€ 290,-**
- RS-232/WiFi adapter for wireless connection to networks and WiFi capable devices, such as tablets, laptops or smartphones, KERN YKI-03, **€ 690,-**
- RS-232/Ethernet adapter for connection to an IP-based Ethernet network, KERN YKI-01, **€ 290,-**
- Further details, plenty of further accessories and suitable printers see *Accessories*

STANDARD



OPTION



FACTORY



Model	Weighing capacity [Max] g	Readability [d] g	Verification value [e] g	Minimal load [Min] g	Linearity g	Weighing plate	Price excl. of VAT ex works €	Option			
								Verification		DAkkS Calibr. Certificate	
								M	€	DAkkS KERN	€
KERN EWJ 300-3	300	0,001	-	-	± 0,005	A	450,-	-	-	963-127	78,-
KERN EWJ 300-3H	300	0,001	-	-	± 0,005	A	490,-	-	-	963-127	78,-
KERN EWJ 3000-2	3000	0,01	-	-	± 0,05	B	430,-	-	-	963-127	78,-
Note: For applications that require verification, please order verificati on at the same time, initial verification at a later date is not possible. Verification at the factory, we need to know the full address of the location of use.											
KERN EWJ 600-2SM	600	0,01	0,1	0,5	± 0,03	B	350,-	965-216	70,-	963-127	78,-
KERN EWJ 600-2M	600	0,01	0,1	0,5	± 0,03	B	360,-	965-216	70,-	963-127	78,-
KERN EWJ 6000-1SM	6000	0,1	1	5	± 0,3	C	340,-	965-217	82,-	963-128	94,-
KERN EWJ 6000-1M	6000	0,1	1	5	± 0,3	C	350,-	965-217	82,-	963-128	94,-



03

All-rounder e.g. as precision balance in the laboratory or in harsh industrial applications

Features

- Thanks to the many typical laboratory functions, such as, for example, recipe function, percentage determination, GLP record keeping, combined with the high level of precision, the KERN 572 is a reliable partner for day-to-day work in the laboratory
- The robust version, typical industrial functions, such as piece-counting, vibrationfree weighing and the large weighing ranges also make these balances ideal for all industrial applications, where a high level of precision is required
- Freely programmable weighing unit, e.g. display direct in special units such as length of thread g/m, paper weight g/m², or similar

- The robust aluminium diecast housing maintains the stability, protects the weighing technology elements and is robust enough to cope with everyday use
- Ring-shaped draught shield standard, only for models with weighing plate size **A**, weighing space $\varnothing \times H$ 157×43 mm
- Model with resolution > 240,000 Pt.: Level indicator to level the balance precisely
- Loop for underfloor weighing, standard for models with [d] ≥ 0,01 g
- Protective working cover included with delivery

Technical data

- Large backlit LCD display, digit height 18 mm
- Dimensions weighing surface, Stainless Steel
 - A** \varnothing 106 mm
 - B** \varnothing 150 mm
 - C** W×D 160×200 mm, see larger picture
- Net weight **A**, **B** approx. 2,4 kg **C** approx. 2,8 kg
- Overall dimensions W×D×H 180×310×85 mm
- Permissible ambient temperature 10 °C/40 °C

Accessories

- Protective working cover, scope of delivery: 5 items, KERN 572-A02S05, **€ 40,-**
- Rechargeable battery pack external, operating time up to 30 h without backlight, charging time approx. 10 h, KERN KS-A01, **€ 160,-**
- Loop and hook for underfloor weighing, for models with [d] ≥ {0,01 g, KERN 572-A03, **€ 25,-**
- **1** Large glass draught shield with 3 sliding doors for easy access to the items being weighed. Weighing space W×D×H 150×140×130 mm, for models with weighing plate size **A**, KERN 572-A05, **€ 230,-**

STANDARD



OPTION



Model	Weighing capacity [Max] g	Readability [d] g	Reproducibility g	Linearity g	Resolution Points	Weighing plate	Price excl. of VAT ex works €	Option	
								DAKKS	Calibr. Certificate
KERN								DAKKS	€
572-30	240	0,001	0,001	± 0,003	240.000	A	520,-	963-127	78,-
572-31	300	0,001	0,002	± 0,005	300.000	A	530,-	963-127	78,-
572-32	420	0,001	0,002	± 0,005	420.000	A	540,-	963-127	78,-
573-34	650	0,01	0,01	± 0,03	65.000	B	530,-	963-127	78,-
572-33	1600	0,01	0,01	± 0,03	160.000	B	490,-	963-127	78,-
572-35	2400	0,01	0,01	± 0,03	240.000	B	500,-	963-127	78,-
572-37	3000	0,01	0,02	± 0,05	300.000	B	510,-	963-127	78,-
572-39	4200	0,01	0,02	± 0,05	420.000	B	520,-	963-127	78,-
572-45	12000	0,05	0,05	± 0,15	240.000	C	500,-	963-128	94,-
572-55	20000	0,05	0,1	± 0,25	400.000	C	530,-	963-128	94,-
573-46	6500	0,1	0,1	± 0,3	65.000	C	530,-	963-128	94,-
572-43	10000	0,1	0,1	± 0,3	100.000	C	490,-	963-128	94,-
572-49	16000	0,1	0,1	± 0,3	160.000	C	500,-	963-128	94,-
572-57	24000	0,1	0,1	± 0,3	240.000	C	500,-	963-128	94,-

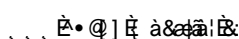

FACE
LIFT



03

High-quality precision scale with comfortable graphic display and enormous weighing range

Features

- Rapid and efficient operation thanks to the graphics display
- **1** Convenient recipe-weighing: with the recipe database, in which up to 99 recipes can be stored, each with up to 20 recipe ingredients with name and target value
- Simple, clear user interface on the display in the following languages: German, English, French, Italian, Spanish, Portuguese
- **2** KERN PLJ 2000-3A: High-quality milligram balance with enormous weighing range up to 2100 g - ideal for large samples or heavy tare containers

- KERN PLJ: Automatic internal adjustment, guarantees high degree of accuracy and makes the balance independent of its location of use. Ideal for mobile applications which require verification, such as ambulatory gold and jewellery purchasing
- Dosage aid: high stability mode and other filter settings can be selected
- Internal memory for complete recipes with name and target value of the recipe ingredients. User guidance through display
- Draught shield standard for models with weighing plate size **A**, weighing space $\varnothing \times H$ 150×60 mm
- Protective working cover included with delivery

Technical data

- Backlit LCD display, digit height 15 mm
- Dimensions weighing surface, stainless steel
A \varnothing 110 mm
B \varnothing 160 mm, see larger picture
C W×D 200×175 mm
- Permissible ambient temperature
 KERN PLS, PLJ: 5 °C/35 °C, 35 °C
 KERN PLJ-M: 15 °C/30 °C

Accessories

- Protective working cover, scope of delivery: 5 items, KERN PLJ-A01S05, **€ 40,-**
- **4** Hook for underfloor weighing, KERN PLJ-A02, **€ 30,-**
- Set for density determination of liquids and solids with density > 1 for models with [d] = 0,001 g, KERN ALT-A02, **€ 830,-**

STANDARD

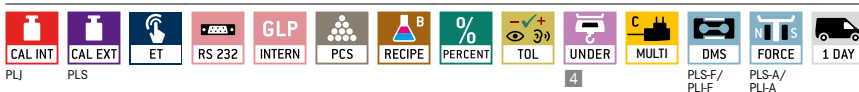

OPTION



FACTORY



Model	Weighing capacity [Max] g	Readability [d] g	Verification value [e] g	Minimal load [Min] g	Linearity g	Weighing plate	Quality code	Price excl. of VAT ex works €	Option			
									Verification		DAkkS Calibr. Certificate	
KERN									MII KERN	€	DAkkS KERN	€
PLS 420-3F	420	0,001	-	-	± 0,004	A	BA	590,-	-	-	963-127	78,-
PLS 720-3A	720	0,001	-	-	± 0,002	A	BC	840,-	-	-	963-103	130,-
PLS 1200-3A	1200	0,001	-	-	± 0,003	A	BC	880,-	-	-	963-103	130,-
PLS 4200-2F	4200	0,01	-	-	± 0,04	B	BA	590,-	-	-	963-127	78,-
PLS 6200-2A	6200	0,01	-	-	± 0,03	B	BC	860,-	-	-	963-104	148,-
PLS 8000-2A	8200	0,01	-	-	± 0,04	B	BC	1040,-	-	-	963-104	148,-
PLS 20000-1F	20000	0,1	-	-	± 0,4	C	BA	570,-	-	-	963-128	94,-
PLJ 420-3F	420	0,001	-	-	± 0,003	A	BA	700,-	-	-	963-127	78,-
PLJ 720-3A	720	0,001	-	-	± 0,002	A	BC	980,-	-	-	963-103	130,-
PLJ 1200-3A	1200	0,001	-	-	± 0,003	A	BC	1000,-	-	-	963-103	130,-
PLJ 2000-3A	2100	0,001	-	-	± 0,004	A	CC	1650,-	-	-	963-103	130,-
PLJ 4200-2F	4200	0,01	-	-	± 0,04	B	BA	690,-	-	-	963-127	78,-
PLJ 6200-2A	6200	0,01	-	-	± 0,03	B	CC	980,-	-	-	963-104	148,-
Note: For applications that require verification, please order verification at the same time, initial verification at a later date is not possible. Verification at the factory, we need to know the full address of the location of use.												
PLJ 720-3AM	720	0,001	0,01	0,02	± 0,002	A	BC	980,-	965-216	70,-	963-103	130,-
PLJ 6200-2AM	6200	0,01	0,1	0,5	± 0,03	B	CC	980,-	965-217	82,-	963-104	148,-



03



The new standard in the laboratory with robust tuning fork weighing system

Features

- KERN PNJ: Automatic internal adjustment, guarantees high degree of accuracy and makes the balance independent of its location of use. Ideal for mobile applications which require verification, such as ambulatory gold and jewellery purchasing
- KERN PNS: Adjusting program CAL for quick setting of the balance accuracy using an external test weight
- High-quality tuning fork measuring system for steady weight values and continuous weighing
- Capacity display: A bargraph display lights up to show how much of the weighing range is still available
- Precise counting: The automatic reference weight optimisation of reference weight gradually improves the average piece weight value
- Compact size, practical for small spaces

- **3** Large, shock proof weighing plate made of Stainless Steel
- Large glass draught shield with 3 sliding doors for easy access to the items being weighed. Weighing space W×D×H 172×171×160 mm, for models with weighing plate size **A**
- Protective working cover included with delivery

Technical data

- Large LCD display, digit height 16,5 mm
- Dimensions weighing surface, Stainless Steel
 - A** Ø 140 mm
 - B** W×D 190×190 mm, see larger picture
- Overall dimensions W×D×H
 - A** 196×293×266 mm
 - B** 196×293×89 mm
- Net weight
 - A** approx. 2,2 kg
 - B** approx. 2,8 kg
- Permissible ambient temperature 5 °C/40 °C

Accessories

- Protective working cover, scope of delivery: 5 items, KERN PNJ-A01S05, **€ 40,-**
- RS-232/Bluetooth adapter to connect to Bluetooth capable devices, such as Bluetooth printers, tablets, laptops, smartphones, etc., KERN YKI-02, **€ 310,-**
- RS-232/WiFi adapter for wireless connection to networks and WiFi capable devices, such as tablets, laptops or smartphones, KERN YKI-03, **€ 690,-**
- RS-232/Ethernet adapter for connection to an IP-based Ethernet network, KERN YKI-01, **€ 290,-**
- **1** Precious stones plate, aluminium with practical spout, W×D×H 123×72×15 mm, KERN AEJ-A05, **€ 40,-**
- Further details, plenty of further accessories and suitable printers see *Accessories*

STANDARD

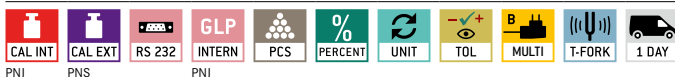

OPTION



FACTORY



Model	Weighing capacity [Max] g	Readability [d] g	Verification value [e] g	Minimal load [Min] g	Linearity g	Weighing plate	Price excl. of VAT ex works €	Option			
								Verification		DAkKS Calibr. Certificate	
KERN							€	€	DAkKS KERN	€	€
PNS 600-3	620	0,001	-	-	± 0,004	A	620,-	-	-	963-103	130,-
PNS 3000-2	3200	0,01	-	-	± 0,02	B	580,-	-	-	963-127	78,-
PNS 12000-1	12000	0,1	-	-	± 0,2	B	570,-	-	-	963-128	94,-
Note: For applications that require verification, please order verificati on at the same time, initial verification at a later date is not possible. Verification at the factory, we need to know the full address of the location of use.											
PNJ 600-3M	620	0,001	0,01	0,02	± 0,004	A	740,-	965-216	70,-	963-103	130,-
PNJ 3000-2M	3200	0,01	0,1	0,5	± 0,02	B	705,-	965-216	70,-	963-127	78,-
PNJ 12000-1M	12000	0,1	1	5	± 0,2	B	705,-	965-217	82,-	963-128	94,-



The classic balance with robust tuning fork measuring system

Features

- **1** KERN EG-N: Internal adjustment in the case of a change in temperature and time-controlled at defined intervals, guarantees high degree of accuracy and makes the balance independent of its location of use
- KERN EW-N: Adjusting program CAL for quick setting of the balance accuracy using an external test weight
- Stable temperature behaviour
- Short stabilisation time
- Shock proof construction
- High corner load performance
- GLP/ISO record keeping of weight values
- Totalising of pieces when counting

- Draught shield standard for models with weighing plate size **A**, weighing space W×D×H 158×130×78 mm
- Protective working cover included with delivery

Technical data

- Large LCD display, digit height 17 mm
- Dimensions weighing surface, Stainless Steel **A** Ø 118 mm, see larger picture **B** W×D 170×140 mm, **C** W×D 180×160 mm
- Overall dimensions W×D×H, without draught shield **A, B** 182×235×75 mm, **C** 192×275×87 mm
- Net weight approx. 1,4 kg
- Permissible ambient temperature 10 °C/30 °C

Accessories

- Protective working cover, scope of delivery: 5 items, for models with weighing plate size **A, B** KERN EG-A05S05, **€ 40,-**, **C** KERN EG-A09S05, **€ 40,-**
- Internal rechargeable battery pack, operating time up to 32 h without backlight, charging time approx. 12 h, for models with weighing plate size **A, B** KERN EG-A04, **€ 110,-**, **C** KERN EG-A06, **€ 110,-**
Note: If the rechargeable battery pack is retrofitted to a verified balance, it must be recalibrated
- **2** Large glass draught shield with 3 sliding doors for easy access to the items being weighed. Weighing space W×D×H 158×130×78 mm, for models with weighing plate size **A**, KERN EG-A03, **€ 250,-**
- Loop for underfloor weighing, for models with weighing plate size **A, B** KERN EG-A07, **€ 40,-**, **C** KERN EG-A08, **€ 40,-**
- Precious stones plate, aluminium with practical spout, W×D×H 83×66×23 mm, KERN AEJ-A05, **€ 40,-**
- Further details, plenty of further accessories and suitable printers see *Accessories*

STANDARD

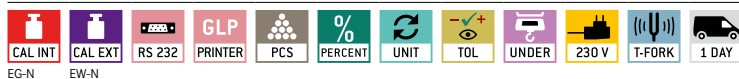

OPTION

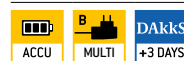

FACTORY



Model	Weighing capacity [Max] g	Readability [d] g	Verification value [e] g	Minimal load [Min] g	Linearity g	Weighing plate	Quality code	Price excl. of VAT ex works €	Option			
									Verification		DAkkS Calibr. Certificate	
KERN									M KERN	€	DAkkS KERN	€
EW 220-3NM	220	0,001	-	-	± 0,002	A	AB	620,-	-	-	963-127	78,-
EW 420-3NM	420	0,001	-	-	± 0,003	A	AB	690,-	-	-	963-127	78,-
EW 620-3NM	620	0,001	-	-	± 0,003	A	AB	770,-	-	-	963-103	130,-
EW 820-2NM	820	0,01	-	-	± 0,01	B	BB	540,-	-	-	963-127	78,-
EW 2200-2NM	2200	0,01	-	-	± 0,01	C	BB	660,-	-	-	963-127	78,-
EW 4200-2NM	4200	0,01	-	-	± 0,02	C	BB	760,-	-	-	963-127	78,-
EW 6200-2NM	6200	0,01	-	-	± 0,03	C	BB	810,-	-	-	963-104	148,-
EW 12000-1NM	12000	0,1	-	-	± 0,2	C	BB	630,-	-	-	963-128	94,-
Note: For applications that require verification, please order verification at the same time, initial verification at a later date is not possible. Verification at the factory, we need to know the full address of the location of use.												
EG 220-3NM	220	0,001	0,01	0,02	± 0,002	A	BB	760,-	965-216 (U)	70,-	963-127	78,-
EG 420-3NM	420	0,001	0,01	0,02	± 0,003	A	BB	830,-	965-216 (U)	70,-	963-127	78,-
EG 620-3NM	620	0,001	0,01	0,1	± 0,004	A	BB	930,-	965-201 (U)	120,-	963-103	130,-
EG 2200-2NM	2200	0,01	0,1	0,5	± 0,01	C	BB	800,-	965-216 (U)	70,-	963-127	78,-
EG 4200-2NM	4200	0,01	0,1	0,5	± 0,02	C	BB	880,-	965-216 (U)	70,-	963-127	78,-



03



Multifunctional laboratory balance with single-cell weighing system and EC type approval [M]

Features

- KERN PBJ: Internal adjustment in the case of a change in temperature and time-controlled at defined intervals, guarantees high degree of accuracy and makes the balance independent of its location of use
- KERN PBS: Adjusting program CAL for quick setting of the balance accuracy using an external test weight
- Metal housing: robust and sturdy
- Dosage aid
- Weighing with tolerance range (checkweighing): a visual signal helps with portioning, dispensing or grading
- Totalising of weights
- Identification number: 4 digits, printed on calibration protocol freely programmable
- Automatic data output to the PC/printer each time the balance is steady

- **1** Draught shield standard for models with [d] = 0,001 g, weighing space W×D×H 180×193×87 mm
- Protective working cover included with delivery

Technical data

- Large backlit LCD display, digit height 14 mm
- Dimensions weighing surface, Stainless Steel
 - A** W×D 108×105 mm
 - B** W×D 170×180 mm, see larger picture
- Overall dimensions W×D×H 209×322×78 mm (without draught shield)
- Net weight approx. 3,2 kg
- Permissible ambient temperature 10 °C/30 °C

Accessories

- Protective working cover, scope of delivery: 5 items, for models with weighing plate size
 - A** KERN PBS-A01S05, € 40,-
 - B** KERN PBS-A02S05, € 40,-
- **2** Set for density determination of liquids and solids with density ≥ 1, for models with weighing plate size
 - A** KERN PBS-A04, € 1600,-
 - B** KERN PBS-A03, € 1650,-
- RS-232/Ethernet adapter for connection to an IP-based Ethernet network, KERN YKI-01, € 290,-
- Further details, plenty of further accessories and suitable printers see *Accessories*

3 Single-cell advanced technology:

- **Fully automatic manufactured weighing cell from one piece of material**
- **Stable temperature behaviour**
- **Short stabilisation time:** steady weight values within approx. 3 s under laboratory conditions
- **Shock proof construction**
- **High corner load performance**

STANDARD

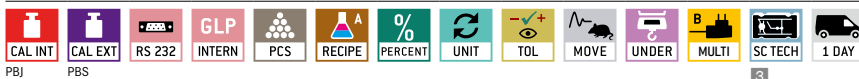

OPTION



FACTORY



Model	Weighing capacity [Max] g	Readability [d] g	Verification value [e] g	Minimal load [Min] g	Linearity g	Weighing plate	Quality code	Price excl. of VAT ex works €	Option				
									Verification		DAkkS Calibr. Certificate		
KERN							QUALITY		M KERN	€	DAkkS KERN	€	
PBS 620-3M	620	0,001	-	-	± 0,002	A	BC	1370,-	-	-	963-103	130,-	
PBS 4200-2M	4200	0,01	-	-	± 0,02	B	BC	1160,-	-	-	963-127	78,-	
PBS 6200-2M	6200	0,01	-	-	± 0,02	B	BC	1390,-	-	-	963-104	148,-	
Note: For applications that require verification, please order verification at the same time, initial verification at a later date is not possible. Verification at the factory, we need to know the full address of the location of use.													
PBJ 620-3M	620	0,001	0,01	0,1	± 0,002	A	BC	1610,-	965-201 U	120,-	963-103	130,-	
PBJ 4200-2M	4200	0,01	0,1	0,5	± 0,02	B	CC	1430,-	965-216 U	70,-	963-127	78,-	
PBJ 6200-2M	6200	0,01	0,1	1	± 0,02	B	CC	1730,-	965-202 U	120,-	963-104	148,-	
PBJ 8200-1M	8200	0,1	1	5	± 0,2	B	CC	1420,-	965-217 U	82,-	963-128	94,-	



03

Robust laboratory and industrial precision scale for heavy items, with EC type approval [M]

Features

- KERN PEJ: Automatic internal adjustment, guarantees high degree of accuracy and makes the balance independent of its location of use
- KERN PES: Adjusting program CAL for quick setting of the balance accuracy using an external test weight
- Metal housing: robust and sturdy
- Weighing with tolerance range (checkweighing): Input of two upper and two lower limit values through four arrow keys. An audible and visual signal assists with the portioning, dispensing or grading
- **1** Draught shield standard for models with [d] = 0,001 g, weighing space W×D×H 170×150×100 mm

- Underfloor weighing: load support with hook on the underside of the balance, standard for models with [d] = 0,001 g, hook not included with the delivery
- **A**, **B** Protective working cover included with delivery

Technical data

- Fluorescent display, bright with high contrast, digit height 14 mm
- Dimensions weighing surface, Stainless Steel
 - A** W×D 140×120 mm
 - B** W×D 200×200 mm, see larger picture
 - C** W×D 250×220 mm
- Overall dimensions W×D×H, without draught shield
 - A** 220×330×90 mm
 - B** 220×339×80 mm
 - C** 260×330×113 mm

- Net weight approx. **A** 4,0 kg, **B** 4,4 kg, **C** 10 kg
- Permissible ambient temperature 10 °C/30 °C

Accessories

- Protective working cover, scope of delivery: 5 items, KERN PES-A04S05, **€ 40,-**
- KERN PES: Internal rechargeable battery pack, operating time up to 32 h, without backlight, charging time approx. 15 h, KERN PES-A01, **€ 610,-**
- Loop for underfloor weighing, for models with weighing plate size **B**, KERN PES-A03, **€ 40,-**
- Relay output to connect relays, signal lamps, valves etc., 5 outputs for weighing in 3 tolerance ranges, must be ordered at purchase, KERN PES-A02, **€ 480,-**
- RS-232/Ethernet adapter for connection to an IP-based Ethernet network, KERN YKI-01, **€ 290,-**
- Further details, plenty of further accessories and suitable printers see *Accessories*

STANDARD

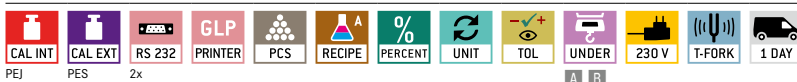

OPTION

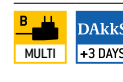

FACTORY

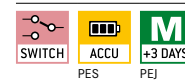

Model	Weighing capacity [Max] [g]	Readability [d] [g]	Verification value [e] [g]	Minimal load [Min] [g]	Linearity [g]	Weighing plate	Quality code	Price excl. of VAT ex works €	Option				
									Verification		DAkkS Calibr. Certificate		
KERN								€	€	DAkkS KERN	€	€	€
PES 620-3M	620	0,001	-	-	± 0,003	A	BB	1220,-	-	-	963-103	130,-	
PES 2200-2M	2200	0,01	-	-	± 0,02	B	BB	840,-	-	-	963-127	78,-	
PES 4200-2M	4200	0,01	-	-	± 0,02	B	BB	1000,-	-	-	963-127	78,-	
PES 6200-2M	6200	0,01	-	-	± 0,03	B	BB	1240,-	-	-	963-104	148,-	
PES 15000-1M	15000	0,1	-	-	± 0,2	B	BB	1190,-	-	-	963-128	94,-	
PES 31000-1M	31000	0,1	-	-	± 0,4	C	CB	2090,-	-	-	963-128	94,-	
Note: For applications that require verification, please order verification on at the same time, initial verification at a later date is not possible.													
Verification at the factory, we need to know the full address of the location of use.													
PEJ 620-3M	620	0,001	0,01	0,1	± 0,003	A	BB	1480,-	965-201 (M)	120,-	963-103	130,-	
PEJ 2200-2M	2200	0,01	0,1	0,5	± 0,02	B	CB	1060,-	965-216 (M)	70,-	963-127	78,-	
PEJ 4200-2M	4200	0,01	0,1	0,5	± 0,02	B	CB	1230,-	965-216 (M)	70,-	963-127	78,-	

04

Analytical balances

Quick-Finder Analytical balances

Readability [d] mg	Weighing capacity [Max] g	Model		Price excl. of VAT ex works €	Page	DAYS	M	CAL INT	CAL EXT	RS 232	RECIPE
		KERN									
0,01	101	ABT 100-5NM		1900,-	42	1	○	●		●	●
0,01 0,1	42 120	ABT 120-5DNM		2000,-	42	1	○	●		●	●
0,01 0,1	52 120	ABP 100-5DM		2660,-	44	1	○	●		●	●
0,01 0,1	82 220	ALJ 200-5DA		1690,-	38	1		●		●	●
0,01 0,1	82 220	ABT 220-5DNM		2060,-	42	1	○	●		●	●
0,01 0,1	102 220	ABP 200-5DM		2850,-	44	1	○	●		●	●
0,1	82	ABS 80-4N		920,-	40	1			●	○	●
0,1	82	ABJ 80-4NM		1030,-	40	1		●		○	●
0,1	82	ACS 80-4		1050,-	40	1			●	○	●
0,1	82	ACJ 80-4M		1160,-	40	1	○	●		●	●
0,1	120	ADB 600-C3	◆	610,-	37	1			●	○	●
0,1	120	ADB 100-4		620,-	37	1			●	○	●
0,1	120	ADJ 600-C3	◆	740,-	37	1		●		○	●
0,1	120	ADJ 100-4		750,-	37	1		●		○	●
0,1	120	ABS 120-4N		1000,-	40	1			●	○	●
0,1	120	ABJ 120-4NM		1050,-	40	1		●		○	●
0,1	120	ACS 100-4		1130,-	40	1			●	○	●
0,1	120	ACJ 100-4M		1180,-	40	1	○	●		●	●
0,1	120	ABT 120-4NM		1450,-	42	1	○	●		●	●
0,1	120	ABP 100-4M		1840,-	44	1	○	●		●	●
0,1	160	ALS 160-4A		960,-	38	1			●	○	●
0,1	160	ALJ 160-4A		1060,-	38	1		●		○	●
0,1	160	ALJ 160-4AM		1130,-	38	1	○	●		●	●
0,1	210	ADB 200-4		640,-	37	1			●	○	●
0,1	210	ADJ 200-4		790,-	37	1		●		○	●
0,1	220	ABS 220-4N		1070,-	40	1			●	○	●
0,1	220	ABJ 220-4NM		1150,-	40	1		●		○	●
0,1	220	ACS 200-4		1190,-	40	1			●	○	●
0,1	220	ACJ 200-4M		1280,-	40	1	○	●		●	●
0,1	220	ABT 220-4NM		1760,-	42	1	○	●		●	●
0,1	220	ABP 200-4M		2220,-	44	1	○	●		●	●
0,1	250	ALS 250-4A		980,-	38	1			●	○	●
0,1	250	ALJ 250-4A		1060,-	38	1		●		○	●
0,1	250	ALJ 250-4AM		1130,-	38	1	○	●		●	●
0,1	310	ALJ 310-4A		1100,-	38	1		●		○	●
0,1	320	ABS 320-4N		1200,-	40	1			●	○	●
0,1	320	ABJ 320-4NM		1320,-	40	1		●		○	●
0,1	320	ACS 300-4		1350,-	40	1			●	○	●
0,1	320	ACJ 300-4M		1470,-	40	1	○	●		●	●
0,1	320	ABT 320-4NM		1960,-	42	1	○	●		●	●
0,1	320	ABP 300-4M		2470,-	44	1	○	●		●	●
0,1	510	ALJ 500-4A		1860,-	38	1		●		○	●

News 2021

◆ = Carat balances

● = standard

○ = option



from €
960,-

KERN ALS-A/ALJ-AM

Page 38/39

- Graphic display and convenient recipe function
- Internal and external adjustment
- Large glass draught shield with 3 sliding doors
- Large weighing capacities at a top price



04

The price leader in analytical balances, also with internal adjustment

Features

- KERN ADJ: Automatic internal adjustment in the case of a change in temperature $\geq 2\text{ }^{\circ}\text{C}$ or timecontrolled every 3 h, guarantees high degree of accuracy and makes the balance independent of its location of use
- KERN ADB: Adjusting program CAL for quick setting of the balance accuracy using an external test weight
- **1** ADB 600-C3: Compact, space-saving carat balance with a readout of 0.001 ct and a weighing range of 600 ct. The high level of accuracy saves hard cash wherever you are weighing valuable precious stones
- Level indicator and levelling feet for precise levelling of the scale, fitted as standard, to give the most accurate weighing result
- Large glass draught shield with 3 sliding doors for easy access to the items being weighed
- Compact size, practical for small spaces
- Simple and convenient 6-key operation

Technical data

- Large backlit LCD display, digit height 16 mm
- Dimensions weighing surface, stainless steel, $\varnothing 90\text{ mm}$
- Overall dimensions (incl. draught shield) W×D×H
KERN ADB/ADJ: 230×310×330 mm
KERN ADB-C/ADJ-C: 230×310×210 mm
- Weighing space W×D×H
KERN ADB/ADJ: 170×160×205 mm
KERN ADB-C/ADJ-C: 170×160×110 mm
- Permissible ambient temperature 10 °C/30 °C

Accessories

- **2** Ioniser to neutralise electrostatic charge, KERN YBI-01A, **€ 890,-**
- **3** Precious stones plate, aluminium with practical spout, W×D×H 83×66×23 mm, KERN AEJ-A05, **€ 40,-**
- **4** Weighing table to absorb vibrations and oscillations, which would otherwise distort the weighing result, KERN YPS-03, **€ 850,-**
- Minimum weight of sample, smallest weight to be weighed, depending on the required process accuracy, only in combination with a DAkkS calibration certificate, KERN 969-103, **€ 10,-**
- Further details, plenty of further accessories and suitable printers see *Accessories*

STANDARD

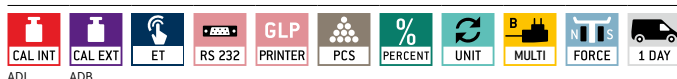

OPTION



Model	Weighing capacity	Readability	Reproducibility	Linearity	Net weight	Price excl. of VAT ex works €	Option	
							DAkkS KERN	DAkkS Calibr. Certificate €
KERN	[Max] g	[d] mg	mg	mg	approx. kg	€	963-101	152,-
ADB 100-4	120	0,1	0,2	$\pm 0,4$	4,4	620,-	963-101	152,-
ADB 200-4	210	0,1	0,2	$\pm 0,4$	4,4	640,-	963-101	152,-
ADB 600-C3	600 ct	0,001 ct	0,002 ct	$\pm 0,004\text{ ct}$	3,8	610,-	963-101	152,-
ADJ 100-4	120	0,1	0,2	$\pm 0,4$	5	750,-	963-101	152,-
ADJ 200-4	210	0,1	0,2	$\pm 0,4$	5	790,-	963-101	152,-
ADJ 600-C3	600 ct	0,001 ct	0,002 ct	$\pm 0,004\text{ ct}$	4,5	740,-	963-101	152,-

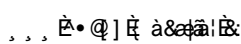

FACE
LIFT



KERN ALJ 200-5DA with optional ionisor **I**, see Accessories. High-precision semi-microbalance. Thanks to its precision, this model is suitable to calibrate pipettes.
Tip: To avoid evaporation, we recommend affordable capillary tubes. (cf. standard 8655)

Analytical balance with high weighing capacity, graphic display and convenient recipe function

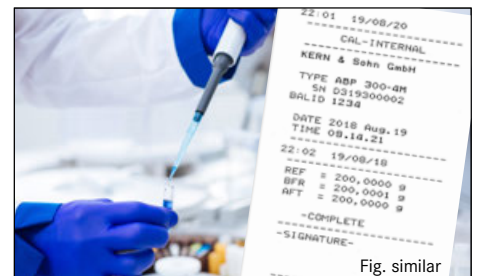
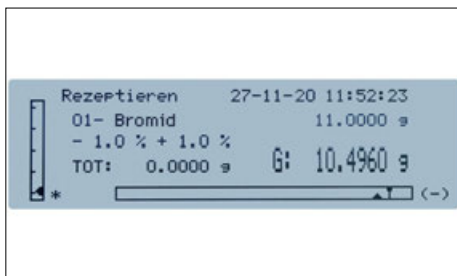

Convenient recipe-weighing: with the recipe database, in which up to 99 recipes can be stored, each with up to 20 recipe ingredients with name and target value

Clear printout with date and time. In addition, the components of the mixture are numbered automatically and printed out with the name and weight

- GLP/ISO record keeping professional, detailed GLP Protocol, so that the balance is completely compliant with the relevant standard requirements in accordance with ISO, GLP and GMP



Features

- **NEW:** Rapid and efficient operation thanks to the graphics display. Simple, clear user interface on the display in the following languages: DE, EN, FR, IT, ES, PT
- ALJ-A03: Ionizer to neutralise electrostatic charge for fixed installation in the analytical balance. Particularly convenient handling as you no longer need a separate device. Simply enable the ionizer fan at the push of a button. Suitable for all models, see *Accessories* on the right
- Adjusting program CAL for quick setting of the balance accuracy using an external *test weight*
- Short stabilisation time: steady weight values within approx. 4 s (models with [d] = 0,1 mg), 6 | 10 s (models with [d] = 0,01 | 0,1 mg) under laboratory conditions
- Weighing with tolerance range (checkweighing): Input of an upper/lower limit value. A visual signal assists with portioning, dispensing or grading
- Dosage aid: high stability mode and other filter settings can be selected
- Internal memory for complete recipes with name and target value of the recipe ingredients. User guidance through Display.
- Ergonomically optimised keypad for left and righthanded users
- Large glass draught shield with 3 sliding doors for easy access to the items being weighed.
- Compact size, practical for small spaces
- Protective working cover included with delivery

Technical data

- Backlit LCD display, digit height 15 mm
- Dimensions weighing surface, stainless steel, \varnothing 80 mm
- Overall dimensions (incl. draught shield) WxDxH 210x340x330 mm
- Weighing space WxDxH 160x140x205 mm
- Net weight 7 kg
- Permissible ambient temperature 5 °C/35 °C

Accessories

- Protective working cover, scope of delivery: 5 items, KERN ALJ-A01S05, **€ 40,-**
- Protective dust cover, KERN ABS-A08, **€ 30,-**
- **1** Draft shield rear panel with integrated ionizer to neutralise electrostatic charge. Is fitted in place of the existing glass rear panel of the draft shield. Suitable for all models in the range, please order at the time you order your balance, the scope of delivery is the rear panel, ionizer, power supply. Factory Option, KERN ALJ-A03, **€ 620,-**
- **2** Set for density determination of liquids and solids with density \leq/\geq 1, the density is indicated directly on the display, KERN YDB-03, **€ 390,-**
- **3** Weighing table to absorb vibrations and oscillations, which would otherwise distort the weighing result, KERN YPS-03, **€ 850,-**
- Minimum weight of sample, smallest weight to be weighed, depending on the required process accuracy, only in combination with a DAkkS calibration certificate, KERN 969-103, **€ 10,-**
- Equipment qualification: compliant qualification concept which includes the following validation services: Installation Qualification (IQ), Operating Qualification (OQ), KERN 961-231B, **€ 750,-**
- Further details, plenty of further accessories and suitable printers see *Accessories*

STANDARD



OPTION



FACTORY



Model	Weighing capacity [Max] g	Readability [d] mg	Verification value [e] mg	Minimal load [Min] mg	Reproducibility mg	Linearity mg	Price excl. of VAT ex works €	Option			
								Verification		DAkkS Calibr. Certificate	
KERN								MD KERN	€	DAkkS KERN	€
ALS 160-4A	160	0,1	-	-	0,1	± 0,3	960,-	-	-	963-101	152,-
ALS 250-4A	250	0,1	-	-	0,1	± 0,3	980,-	-	-	963-101	152,-
Note: For applications that require verification, please order verification at the same time, initial verification at a later date is not possible. Verification at the factory, we need to know the full address of the location of use.											
ALJ 200-5DA	82 220	0,01 0,1	-	-	0,04 0,1	± 0,1 0,2	1690,-	-	-	963-101	152,-
ALJ 160-4A	160	0,1	-	-	0,1	± 0,3	1060,-	-	-	963-101	152,-
ALJ 160-4AM	160	0,1	1	10	0,2	± 0,3	1130,-	965-201	120,-	963-101	152,-
ALJ 250-4A	250	0,1	-	-	0,1	± 0,3	1060,-	-	-	963-101	152,-
ALJ 250-4AM	250	0,1	1	10	0,2	± 0,3	1130,-	965-201	120,-	963-101	152,-
ALJ 310-4A	310	0,1	-	-	0,1	± 0,3	1100,-	-	-	963-101	152,-
ALJ 500-4A	510	0,1	-	-	0,2	± 0,4	1860,-	-	-	963-101	152,-

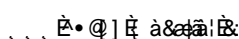

04

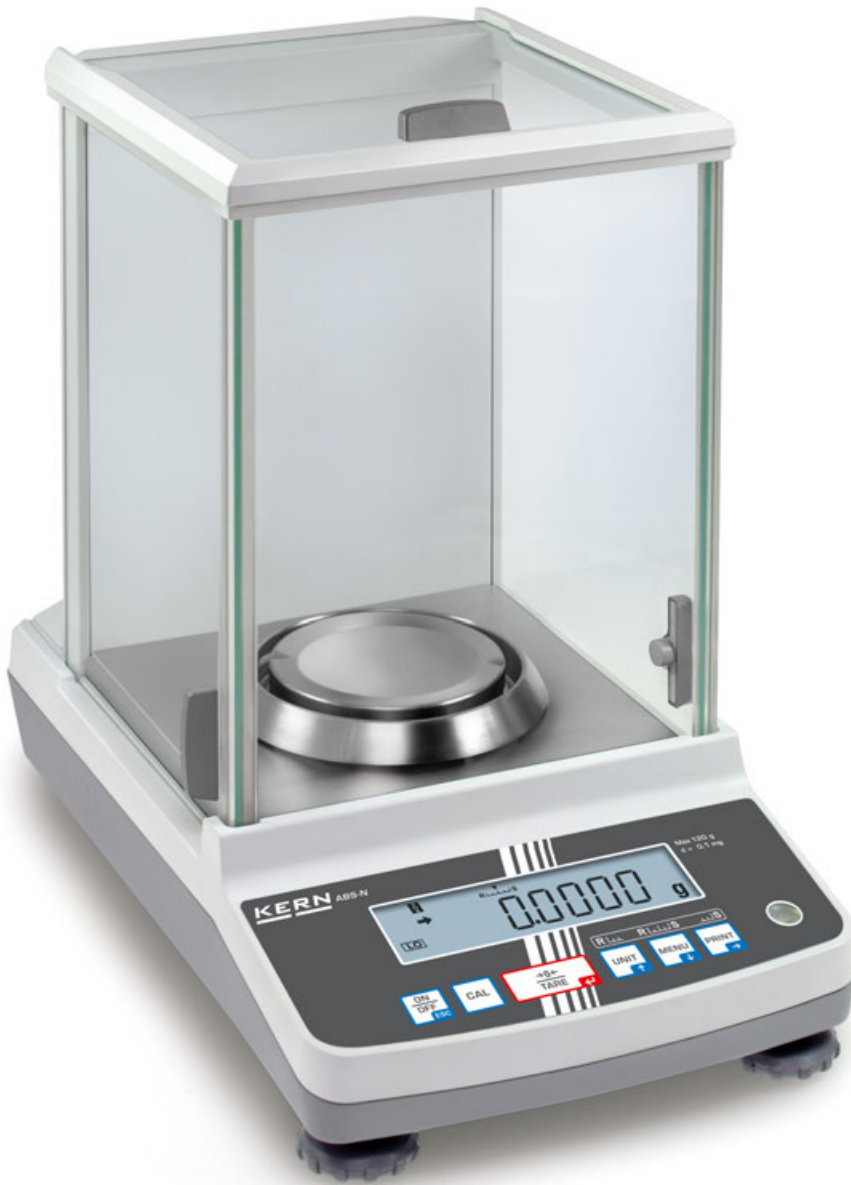

KERN ACS/ACJ with standard data interface RS-232 and USB

The bestseller in analytical balances, with high-quality single-cell weighing system, also with EC type approval [M]

Features

- ABJ-NM: Automatic internal adjustment in the case of a change in temperature $\geq 2\text{ }^{\circ}\text{C}$ or timecontrolled every 4 h, guarantees high degree of accuracy and makes the balance independent of its location of use
- ABS-N: Adjusting program CAL for quick setting of the balance accuracy using an external test weight
- Dosage aid
- Simple recipe weighing and documenting with a combined tare/print function. In addition, the ingredients for the recipe are numbered automatically and printed out with their corresponding number and nominal weight
- Automatic data output to the PC/printer each time the balance is steady
- Identification number: 4 digits, printed on calibration protocol freely programmable
- ABJ-NM has OIML certification
- Protective working cover included with delivery

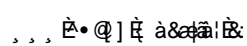



Technical data

- Large LCD display, digit height 14 mm
- Dimensions of weighing surface, stainless steel, \varnothing 91 mm
- Overall dimensions (incl. draught shield) WxDxH 210x340x325 mm
- Weighing space WxDxH 174x162x227 mm
- Net weight 6 kg
- Permissible ambient temperature 10 °C/30 °C

Accessories

- Protective working cover, scope of delivery: 5 items, KERN ACS-A02S05, **€ 40,-**
- **1** Set for density determination of liquids and solids with density $\leq/\geq 1$, the density is indicated directly on the display, KERN YDB-03, **€ 390,-**
- **2** Ioniser to neutralise electrostatic charge, KERN YBI-01A, **€ 890,-**
- KERN ABS-N/ABJ-NM: Data interface RS-232, interface cable included, approx. 1,5 m KERN ACS-A01, **€ 90,-**
- **3** Weighing table to absorb vibrations and oscillations, which would otherwise distort the weighing result, KERN YPS-03, **€ 850,-**
- Minimum weight of sample, smallest weight to be weighed, depending on the required process accuracy, only in combination with a DAkkS calibration certificate, KERN 969-103, **€ 10,-**
- Further details, plenty of further accessories and suitable printers see *Accessories*



Single-cell advanced technology:

- **Fully automatic manufactured weighing cell from one piece of material**
- **Stable temperature behaviour**
- **Short stabilisation time:** steady weight values within approx. 3 s under laboratory conditions
- **Shock proof construction**
- **High corner load performance**

04

STANDARD

CAL INT
 CAL EXT
 RS 232
 USB
 GLP
 PRINTER
 PCS
 RECIPE
 PERCENT
 UNIT
 TOL
 MULTI
 SC TECH
 1 DAY

OPTION

RS 232
 DAkkS
 +3 DAYS

FACTORY

M
 +3 DAYS

Model	Weighing capacity [Max]	Readability	Verification value	Minimal load	Reproducibility	Linearity	Price excl. of VAT ex works €	Option			
								Verification		DAkkS Calibr. Certificate	
								MI	€	DAkkS KERN	€
KERN	g	[d] mg	[e] mg	[Min] mg	mg	mg	€	€	€	€	
ABS 80-4N	82	0,1	-	-	0,2	± 0,3	920,-	-	-	963-101 152,-	
ABS 120-4N	120	0,1	-	-	0,2	± 0,3	1000,-	-	-	963-101 152,-	
ABS 220-4N	220	0,1	-	-	0,2	± 0,3	1070,-	-	-	963-101 152,-	
ABS 320-4N	320	0,1	-	-	0,2	± 0,3	1200,-	-	-	963-101 152,-	
Note: For applications that require verification, please order verification at the same time, initial verification at a later date is not possible. Verification at the factory, we need to know the full address of the location of use.											
ABJ 80-4NM	82	0,1	1	10	0,2	± 0,3	1030,-	-	-	963-101 152,-	
ABJ 120-4NM	120	0,1	1	10	0,2	± 0,3	1050,-	-	-	963-101 152,-	
ABJ 220-4NM	220	0,1	1	10	0,2	± 0,3	1150,-	-	-	963-101 152,-	
ABJ 320-4NM	320	0,1	1	10	0,2	± 0,3	1320,-	-	-	963-101 152,-	
ACS 80-4	82	0,1	-	-	0,2	± 0,3	1050,-	-	-	963-101 152,-	
ACS 100-4	120	0,1	-	-	0,2	± 0,3	1130,-	-	-	963-101 152,-	
ACS 200-4	220	0,1	-	-	0,2	± 0,3	1190,-	-	-	963-101 152,-	
ACS 300-4	320	0,1	-	-	0,2	± 0,3	1350,-	-	-	963-101 152,-	
Note: For applications that require verification, please order verification at the same time, initial verification at a later date is not possible. Verification at the factory, we need to know the full address of the location of use.											
ACJ 80-4M	82	0,1	1	10	0,2	± 0,3	1160,-	965-201 120,-	963-101	152,-	
ACJ 100-4M	120	0,1	1	10	0,2	± 0,3	1180,-	965-201 120,-	963-101	152,-	
ACJ 200-4M	220	0,1	1	10	0,2	± 0,3	1280,-	965-201 120,-	963-101	152,-	
ACJ 300-4M	320	0,1	1	10	0,2	± 0,3	1470,-	965-201 120,-	963-101	152,-	



The premium model with single-cell weighing system

Features

- Automatic internal adjustment in the case of a change in temperature $\geq 0,5 \text{ }^\circ\text{C}$ or timecontrolled every 4 h, guarantees high degree of accuracy and makes the balance independent of its location of use
- Dosage aid: High-stability mode and other filter settings can be selected
- Simple recipe weighing and documenting with a combined tare/print function. In addition, the ingredients for the recipe are numbered automatically and printed out with their corresponding number and nominal weight
- Identification number: 4 digits, printed on calibration protocol freely programmable
- Automatic data output to the PC/printer each time the balance is steady
- Large glass draught shield with 3 sliding doors for easy access to the items being weighed.
- Protective working cover included with delivery

Technical data

- Large LCD display, digit height 14 mm
- Dimensions weighing surface, stainless steel, $\varnothing 80 \text{ mm}$
- Overall dimensions (incl. draught shield) WxDxH 217x356x338 mm
- Weighing space WxDxH 168x172x223 mm
- Net weight approx. 7 kg
- Permissible ambient temperature $10 \text{ }^\circ\text{C}/30 \text{ }^\circ\text{C}$

Accessories

- Protective working cover, scope of delivery: 5 items, KERN ABT-A02S05, € 40,-
- 1 Set for density determination of liquids and solids with density $\leq/\geq 1$, the density is indicated directly on the display, KERN YDB-03, € 390,-
- 2 Ioniser to neutralise electrostatic charge, KERN YBI-01A, € 890,-

- 3 Weighing table to absorb vibrations and oscillations, which would otherwise distort the weighing result, KERN YPS-03, € 850,-
- Minimum weight of sample, smallest weight to be weighed, depending on the required process accuracy, only in combination with a DAkkS calibration certificate, KERN 969-103, € 10,-
- Further details, plenty of further accessories and suitable printers see *Accessories*

4 Single-cell advanced technology:

- **Fully automatic manufactured weighing cell from one piece of material**
- **Stable temperature behaviour**
- **Short stabilisation time:** steady weight values within approx. 4 s under laboratory conditions
- **Shock proof construction**
- **High corner load performance**

STANDARD

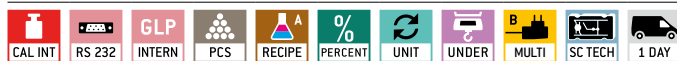

OPTION



FACTORY



Model	Weighing capacity [Max] g	Readability [d] mg	Verification value [e] mg	Minimal load [Min] mg	Reproducibility mg	Linearity mg	Price excl. of VAT ex works €	Option			
								Verification		DAkkS Calibr. Certificate	
KERN							M1 KERN	€	DAkkS KERN	€	
ABT 120-4NM	120	0,1	1	10	0,1	$\pm 0,2$	1450,-	965-201	120,-	963-101	152,-
ABT 220-4NM	220	0,1	1	10	0,1	$\pm 0,2$	1760,-	965-201	120,-	963-101	152,-
ABT 320-4NM	320	0,1	1	10	0,1	$\pm 0,3$	1960,-	965-201	120,-	963-101	152,-
ABT 100-5NM	101	0,01	1	1	0,05	$\pm 0,15$	1900,-	965-201	120,-	963-101	152,-
Dual-range balance switches automatically to the next largest weighing capacity [Max] and readability [d]											
ABT 120-5DNM	42 120	0,01 0,1	1	1	0,02 0,1	$\pm 0,05 0,2$	2000,-	965-201	120,-	963-101	152,-
ABT 220-5DNM	82 220	0,01 0,1	1	1	0,05 0,1	$\pm 0,1 0,2$	2060,-	965-201	120,-	963-101	152,-

Note: For applications that require verification, please order verification at the same time, initial verification at a later date is not possible. Verification at the factory, we need to know the full address of the location of use.



TIPS FROM THE EXPERTS

As well as our balances and test services, we can offer you an extensive range of microscopes and refractometers.

We will offer you reliable quality at fair prices and with the shortest delivery times. Our product specialists will give you professional advice, will work with you to find the right product and will provide comprehensive support after the purchase too.

This ensures a high level of investment security and a good feeling – KERN, the nice balance manufacturer from the wilds of Southern Germany.

For all details on our ranges, please see www.kern-sohn.com or request your own personal catalogues right now: Telephone +49 7433 9933-0



*Daniel Junger,
Head of Product Management
Optical devices*

“No compromises with optical device”

KERN offers you a complete, carefully-designed range of biological microscopes, stereo microscopes, metallurgical microscopes, polarisation microscopes, especially flexible, preconfigured stereomicroscope sets, individually configurable stereomicroscope systems as well as microscope cameras and camera software

“High-precision refractive index measurement for laboratories and industry”

Quick and easy determination of measured values, whether on site, in production or in the laboratory, ensuring safety, consistent quality and accelerating processes. This is what KERN's analog and digital refractometers stand for and at an extremely attractive price in consistently high quality.

All microscopes, microscope cameras, refractometers and a variety of practical accessories can be found in the new KERN Catalog of Microscopes & Refractometers 2021.



KERN OBE-13



04

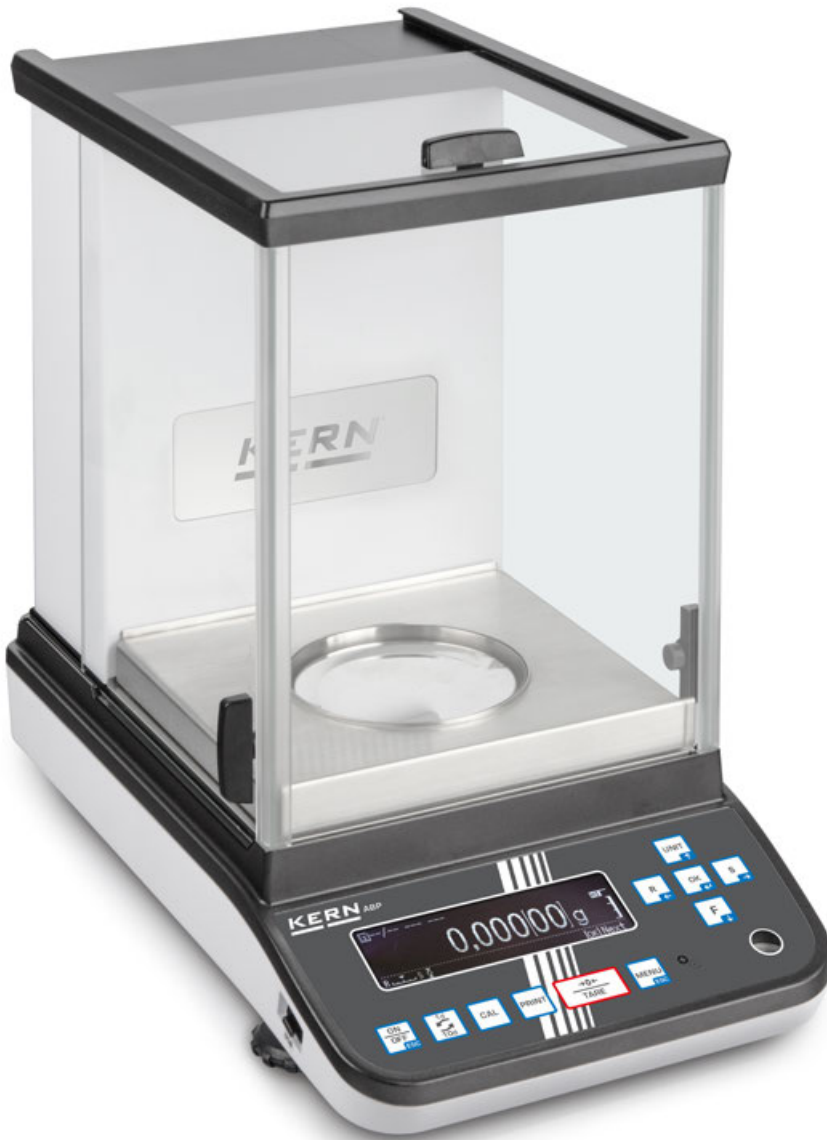

2 KERN ABP 100-5DM with optional ionizer

1 **NEW:** Extremely fast ionization process, thanks to the latest generation of KERN ionization technology to neutralise electrostatic charge for fixed installation in the analytical balance. Particularly convenient handling as you no longer need a separate device. Simply enable the ionizer fan at the push of a button. Suitable for all models

Premium analytical balance with the latest Single-Cell Generation for extremely rapid, stable weighing results



Bright OLED display with large viewing angle for the very best readout from a wide range of lines of sight or poor lighting conditions



USB data interfaces and RS-232 for transferring weighing data to the PC, tablet, printer, USB as well as connecting external devices, such as barcode scanner (option), numeric keypad (option) etc.



GLP/ISO record keeping professional and detailed GLP protocol, so that the scale is fully compliant with the relevant standard requirements according to ISO, GLP and GMP

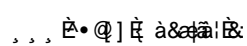



Features

- This new generation of analytical balances combines the highest level of precision with large weighing ranges. Thanks to the new Single-Cell Generation, the weighing result is displayed in a fraction of the time with comparable models. Together with the intuitively structured menu, this means that you can work efficiently and rapidly
- Navigation pad for super quick navigating through the menus
- Automatic internal adjustment in the case of a change in temperature $\geq 1\text{ }^{\circ}\text{C}$ or time-controlled every 4 h, guarantees high degree of accuracy and makes the balance independent of its location of use
- The Minimum weight of sample can be manually stored in the device or automatically calculated. For weighings below this value, the balance issues a warning message
- Dosage aid: High-stability mode and other filter settings can be selected
- Simple recipe weighing and documenting with a combined tare/print function. In addition, the ingredients for the recipe are numbered automatically and printed out with their corresponding number and nominal weight
- Individual user settings can be stored for up to 10 users: user name/number (can be printed out or added to the record for each process), password, menu language, user profiles, accessing user settings via barcode, additional guest mode for users who are not logged in, authorizations, eg. B. balance adjustment, changing settings or conditioning or modification of a recipe only by the authorized person & performing the formulation by the user
- U.S. FDA 21 Part 11: assists you in data integrity in accordance with U.S. FDA 21 Part 11 (for example weighing result, sample ID, user name, scales ID, ...)

- Menu languages DE, EN
- Automatic data output to the PC/printer each time the balance is steady
- Large glass draught shield with 3 sliding doors for easy access to the items being weighed.
- **1** KERN ABP-DM: Multi-function weighing plate included with delivery, minimises the effect of currents of air in the weighing chamber and therefore significantly improves the stabilisation time and repeatability. In addition samples, sample paper, PCR containers, micro centrifuge tubes and many other items which protrude can be easily fixed in place and weighed easily
- Protective working cover included with delivery

Technical data

- Luminescent OLED display, digit height 14 mm, bright with high contrast, for easy reading of the weight, even in poor lighting conditions
- Dimensions weighing surface $\varnothing 91\text{ mm}$
- Overall dimensions (incl. draught shield) WxDxH, 213x433x344 mm
- Weighing space WxDxH 166x156x220 mm
- Net weight approx. 8 kg
- Permissible ambient temperature $10\text{ }^{\circ}\text{C}/30\text{ }^{\circ}\text{C}$

Accessories

- Protective working cover, scope of delivery: 5 items, KERN YBA-A06S05, **€ 40,-**
- Set for density determination of liquids and solids with density $\leq/\geq 1$, the density is indicated directly on the display, KERN YDB-03, **€ 390,-**

- **2** Draft shield rear panel with integrated ioniser to neutralise electrostatic charge. Is fitted in place of the existing glass rear panel of the draft shield. Suitable for all models in the KERN ABP range, please order at the time you order your balance, the scope of delivery is the rear panel, ioniser, power supply. Factory Option, KERN ABP-A01, **€ 1710,-**
- USB barcode scanner, hand-held version, dimensions WxDxH 152x84x63 mm, KERN PET-A09, **€ 350,-**
- USB keyboard for easy capture of items, descriptions etc., dimensions WxDxH 440x128x24 mm, KERN PET-A06, **€ 45,-**
- **3** Weighing table to absorb vibrations and oscillations, which would otherwise distort the weighing result, KERN YPS-03, **€ 850,-**
- Minimum weight of sample, smallest weight to be weighed, depending on the required process accuracy, only in combination with a DAkKS calibration certificate, KERN 969-103, **€ 10,-**
- Equipment qualification: compliant qualification concept which includes the following validation services, Installation Qualification (IQ), Operating Qualification (OQ), KERN 961-231B, **€ 750,-**
- Further details, plenty of further accessories and suitable printers see *Accessories*

Single-cell advanced technology:

- **Fully automatic manufactured weighing cell from one piece of material**
- **Stable temperature behaviour**
- **Short stabilisation time:** steady weight values within approx. 2 s (models with [d] = 0,1 mg), approx. 8 s (models with [d] = 0,01 mg) under laboratory conditions
- **Shock proof construction**
- **High corner load performance**

STANDARD

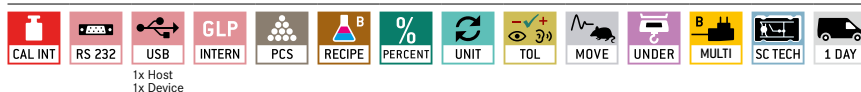

OPTION

FACTORY



Model	Weighing capacity [Max] g	Readability [d] mg	Verification value [e] mg	Minimal load [Min] mg	Reproducibility mg	Linearity mg	Price excl. of VAT ex works €	Option					
								Verification		DAkKS Calibr. Certificate			
KERN								MI KERN	€	DAkKS KERN	€		
ABP 100-4M	120	0,1	1	10	0,1	$\pm 0,2$	1840,-	965-201	120,-	963-101	152,-		
ABP 200-4M	220	0,1	1	10	0,1	$\pm 0,2$	2220,-	965-201	120,-	963-101	152,-		
ABP 300-4M	320	0,1	1	10	0,2	$\pm 0,3$	2470,-	965-201	120,-	963-101	152,-		
Dual-range balance switches automatically to the next largest weighing capacity [Max] and readability [d]													
ABP 100-5DM	52 120	0,01 0,1	1	1	0,02 0,1	$\pm 0,05 0,2$	2660,-	965-201	120,-	963-101	152,-		
ABP 200-5DM	102 220	0,01 0,1	1	1	0,05 0,1	$\pm 0,1 0,2$	2850,-	965-201	120,-	963-101	152,-		

Note: For applications that require verification, please order verification at the same time, initial verification at a later date is not possible. Verification at the factory, we need to know the full address of the location of use.

05

Moisture analysers

During the processing and production of many raw and finished products, the correct moisture level is a measure for quality and determines the shelf life, storage time or viscosity of the product. KERN moisture analysers work with halogen and infra-red drying methods and deliver accurate results through a multitude of functions.

Our drying balances have a number of memories, network connectivity, different drying modes and are easy to use due to the intuitive operation and easy-to-read displays. Our high-quality moisture analysers are ideal for use in the food processing industry, water resource management, plastics industry, the energy industry or agriculture.

Halogen moisture analysers for rapid, reliable measuring results

Our models work on the thermogravimetric principle. This means the sample is weighed and warmed with a halogen lamp. During this procedure, the weight loss is recorded continuously while it is drying until it reaches the defined value. The current moisture content for the sample can then be automatically calculated from the measured weight difference.

All the benefits of our moisture analysers with halogen and infra-red drying:

- Even heating of the sample without risk of burning
- Rapid amortisation through low purchase costs
- Temperature ranges from 35 to 200 degrees
- High level of measurement accuracy to 0.01 %
- Spare capacity, weighing range up to 200 g
- You can select between different heating profiles
- You can select between different switch-off criteria, automatic or time-controlled

The drying programs

Depending on the model, our moisture analysers within the laboratory balance category have different heating profiles, so the procedure can be adapted to best suit the sample in question.

- The standard drying setting is suitable for most types of sample. As an option you can choose between these two types of switch-off criteria: Automatic drying (AUTO) or time-controlled (TIME).
- Rapid drying is suitable for samples with a high moisture content.
- Smooth heating through gentle drying prevents disintegration and formation of a skin
- As an alternative to rapid drying, you can also use stage drying as well. The temperature and the time period for the increase in temperature can be freely selected. Equally, the moisture can be determined selectively for different temperatures.

Our recommendation: The high-performance DBS moisture analyser with excellent stability, reliability and reaction speed, 10 drying programs can be stored and memory for 100 drying processes carried out as well as a USB and RS 232 data interface.

Simple data transfer

For easy, convenient communication between the moisture analyser and printer, or PC there are interfaces available, for example to connect a USB or Ethernet. The devices themselves have several internal memories, where you can store drying programs with drying parameters, such as, for example, drying period, drying temperature, display settings, switch-off criteria etc. This saves time and guarantees repeatable results. Compatible printers to print out weights, calibration and interface kits are available in our extensive range of accessories, suitable for each moisture analyser.





For communication between the balance and the printer, the moisture analyser must be disconnected from the power supply and connected to the printer. We guarantee fault-free operation with the KERN interface cable. To transfer the values to the PC we recommend our "Balance Connection KERN SCD 4.0" transfer software. As GLP-compliant laboratory software, the program supports balances and measuring devices with RS 232, RS 485, Bluetooth, LAN and WiFi networks. Programs such as Excel or other spreadsheet applications are ideal for displaying graphics.

Our recommendation: DLB moisture analyser with intuitive graphics display, multi-lingual user guidance, convenient Auto-Tare when closing the lid and RS 232 data interface

Our service options

In order for the comparability of the results of moisture analyses to be guaranteed, the correct temperatures must be maintained in the heating chamber or sample. We offer our customers regular calibration of the temperature for genuine, reliable measuring results KERN 964-305, € 140,- If requested, we can carry out sample analysis for you and support you in adjusting the parameters of your moisture analyser KERN 965-243, € 95,-/hour Please contact your personal customer advisor if you would like us to help!

Quick-Finder Moisture analysers

Readability [d] g	Weighing capacity [Max] g	Model KERN	Price excl. of VAT ex works €	Page	 DAYS	 CAL EXT	 MEMORY	 RS 232
For an explanation on the pictos, see front flap								
0,001	60	DBS 60-3	1270,-	48	1	●	●	●
0,001	110	DAB 100-3	1050,-	47	1	●	●	●
0,001	160	DLB 160-3A	1150,-	49	1	●	●	●
0,01	200	DAB 200-2	950,-	47	1	●	●	●

● = standard ○ = option

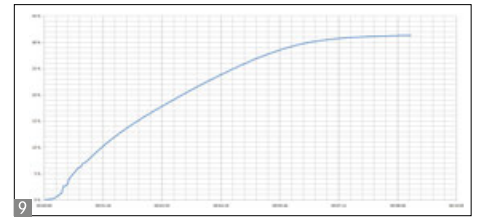
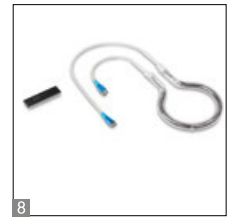
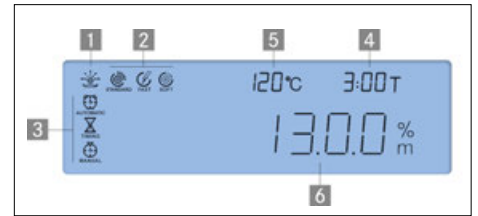
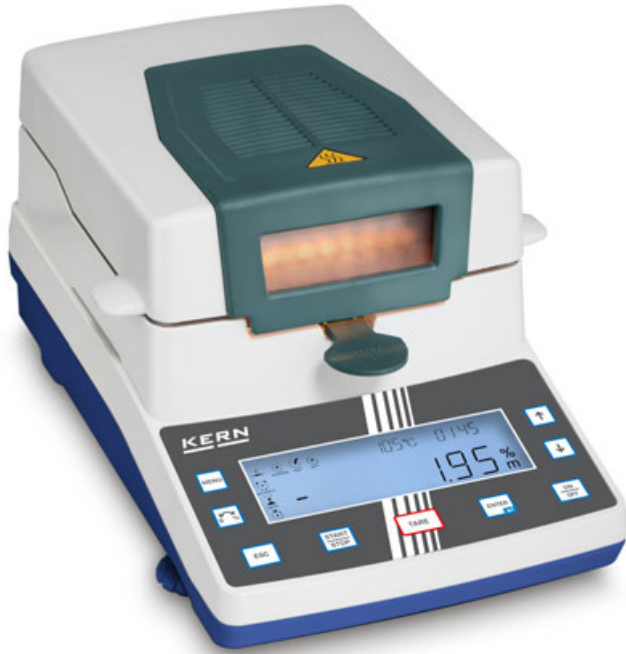

Particularly user-friendly moisture analyzer with high-quality halogen quartz glass heater- also available as version with [d] = 10 mg, ideal for recurring rapid tests

Features

- KERN DAB 200-2: Version with lower resolution, whereby the switch-off criterion is reached faster, which saves time. Ideal for quick tests and spot checks
- Backlit graphic display, digit height 14 mm
- 1 Drying process active
- 2 Active heating profile
- 3 Active switch-off criteria
- 4 Previous drying time
- 5 Current temperature
- 6 Current moisture content in %

- Halogen quartz glass heater 400 W
- Observation window above the sample, useful during initial setting
- Internal memory for automatic sequence of 15 complete drying processes and 5 drying processes carried out
- The last value measured remains on the display until it is replaced by a new measurement
- 50 sample plates included

- Application handbook: On the internet, you will find a practical application handbook containing many examples, field reports, settings and tips for each KERN moisture analyser

STANDARD

CAL EXT MEMORY RS 232 GLP UNIT 230 V DMS 1 DAY

OPTION

DAkkS +3 DAYS

Model KERN	DAB 200-2	DAB 100-3
Readability [d]	0,01 g/0,05 %	0,001 g/0,01 %
Weighing capacity [Max]	200 g	110 g
Reproducibility weight of sample 2 g*	1,5 %	0,15 %
Reproducibility, weight of sample 10 g*	0,3 %	0,03 %
Display after drying (Display can be switched over at any time)		
Moisture [%] = Moisture content (M) from wet weight (W)	0 - 100 %	
Dry content [%] = Dry weight (D) from W	100 - 0 %	
Moisture content (M)	Absolute value in [g]	
Temperature range	40 °C - 199 °C in steps up to 1 °C	
Drying modes	<input type="checkbox"/> Standard drying <input type="checkbox"/> Gentle drying <input type="checkbox"/> Rapid drying	
Switch-off criteria	• Automatic switch-off (2 mg loss in weight in 45 s) • Time controlled switch-off (3 min - 99 min 59 s, 10 s increments) • Manual switch-off at the press of a button	
Recall of measurement/ Log output	Interval can be set from 1 s - 10 min (Only when used with printer or PC)	
Overall dimensions WxDxH	240x365x180 mm	
Net weight	4,82 kg	
Price €, excl. of VAT, ex works	950,-	1050,-
Option DAkkS Calibr. Certificate	Mass: KERN 963-127, € 78,-	
Option Factory Calibr. Certificate	Temperature: KERN 964-305, € 140,-	

* application-dependent

Accessories

- Sample plates aluminium, ø 90 mm, unit of 80 pieces, KERN MLB-A01A, € 45,-
- Round fiberglass filter high mechanical stability, with organic binder, box of 100 pieces, KERN RH-A02, € 80,-
- Round fiberglass filter, medium mechanical stability, without organic binder, box of 100 pieces, KERN YMF-A01, € 40,-
- 7 Temperature calibration set consists of measuring sensor and display device, KERN DAB-A01., € 110,-
- 8 Infrared quartz glass heater, temperature range 40 °C-160 °C, Factory Option, KERN DAB-A02, € 165,-
- RS-232/Ethernet adapter for connection to an IP-based Ethernet network, KERN YKI-01, € 290,-
- RS-232/Bluetooth adapter to connect to Bluetooth capable devices, such as Bluetooth printers, tablets, laptops, smartphones, etc., KERN YKI-02, € 310,-
- RS-232/WiFi adapter for wireless connection to networks and WiFi capable devices, such as tablets, laptops or smartphones, KERN YKI-03, € 690,-
- 9 Display of the drying process in conjunction with BalanceConnection, KERN SCD-4.0, € 150,-
- Thermal printer, KERN YKB-01N, € 310,-
- Matrix needle printer, to print the weights on normal paper, ideal for long-term archiving, KERN 911-013, € 390,-

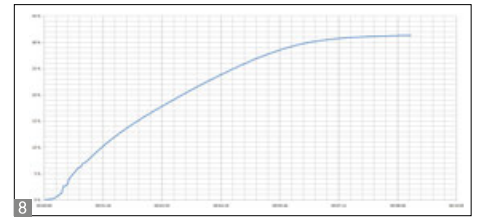
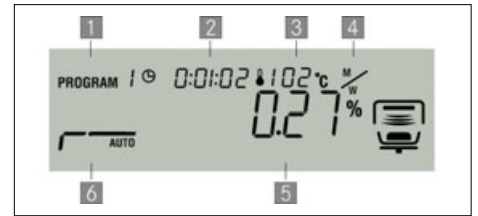

Moisture analyzer with high-quality single-cell weighing system for outstanding stability, reliability and response speed

Features

- Tip: Suitable for samples with low moisture content, e.g. plastics
- Backlit graphic display, digit height 15 mm
- 1 Drying process active
- 2 Previous drying time
- 3 Current temperature
- 4 Unit for displaying the results
- 5 Current moisture content in %
- 6 Active heating profile

- Halogen quartz glass heater 400 W
- Excellent temperature control thanks to halogen technology, suitable for temperature-sensitive samples
- Internal memory for automatic sequence of 10 complete drying processes and 100 drying processes carried out
- The last value measured remains on the display until it is replaced by a new measurement

- Password protection to prevent manipulation of stored settings, data, etc.
- Sample description for up to 99 samples, 2 digits, freely programmable, and is printed in the measuring protocol
- Date and time display as standard
- USB data interface for transferring weighing data to the PC, printer etc. *Can only be used in combination with KERN DBS-A02
- 10 sample plates included
- Protective working cover included with delivery
- Application handbook: On the internet, you will find a practical application handbook containing many examples, field reports, settings and tips for each KERN moisture analyser

STANDARD

CAL EXT MEMORY RS 232 USB GLP INTERN UNIT 230 V FORCE SC TECH 1 DAY

OPTION

DAkKS +3 DAYS

Modell KERN	DBS 60-3
Readability [d]	0,001 g/0,01 %
Weighing capacity [Max]	60 g
Reproducibility weight of sample 2 g*	0,15 %
Reproducibility, weight of sample 10 g*	0,02 %
Display after drying	
Moisture [%] = Moisture content (M) from wet weight (W)	0-100 %
Dry content [%] = Dry weight (D) from W	100-0 %
ATRO [%] [(W-D) : D] · 100%	0-999 %
Moisture content (M)	Absolute value in [g]
Temperature range	50 °C-200 °C in steps up to 1 °C
Drying modes	<input type="checkbox"/> Standard drying <input type="checkbox"/> Drying in levels <input type="checkbox"/> Gentle drying <input type="checkbox"/> Rapid drying
Switch-off criteria	• Automatic unrestricted switch-off (Selectable loss in weight 0,01%-0,1% in 30 s) • Time controlled switch-off (1 min - 12 h) • Manual switch-off at the press of a button
Recall of measurement/ Log output	Interval can be set from 1 s - 10 min (Only when used with printer or PC)
Overall dimensions WxDxH	204x336x167 mm
Net weight	approx. 4,6 kg
Price €, excl. of VAT, ex works	1270,-
Option DAkKS Calibr. Certificate	Mass: KERN 963-127, € 78,-
Option Factory Calibr. Certificate	Temperature: KERN 964-305, € 140,-

* application-dependent

Accessories

- Protective working cover, scope of delivery: 5 items, KERN DBS-A03S05, € 65,-
- Sample plates aluminium, ø 90 mm, unit of 80 pieces, KERN MLB-A01A, € 45,-
- Round fiberglass filter high mechanical stability, with organic binder, box of 100 pieces, KERN RH-A02, € 80,-
- 7 Temperature calibration set consists of measuring sensor and display device, KERN DBS-A01., € 450,-
- USB interface kit for bi-directional data exchange between balance/moisture analyser and computer. Scope of delivery: USB cable, driver, Software Balance Connection, KERN DBS-A02, € 290,-
- 8 Display of the drying process in conjunction with BalanceConnection, KERN SCD-4.0, € 150,-
- Thermal printer, KERN YKB-01N, € 310,-
- Matrix needle printer, to print the weights on normal paper, ideal for long-term archiving, KERN 911-013, € 390,-
- Label printer, KERN YKE-01, € 590,-

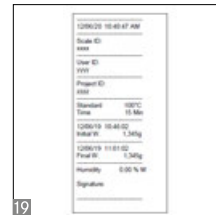
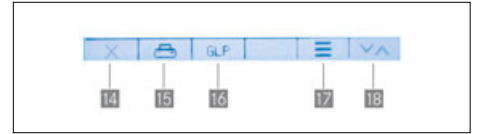
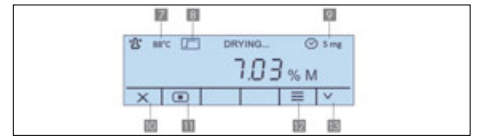

Moisture analyzer with intuitive graphic display and step-by-step user guidance in 6 languages

Features

- Rapid and efficient operation thanks to the graphics display
- Backlit graphics display, digit height 11 mm
- Start screen:
 - 1 Main menu
 - 2 Start drying process
 - 3 Select drying temperature
 - 4 Select shut-off criteria
 - 5 Setting to zero/taring
 - 6 Stand-by
- During measurement:
 - 7 Current temperature

- 8 Current heating profile
 - 9 Active shut-off criteria
 - 10 Abort drying process
 - 11 Stop drying process
 - 12 Display current drying parameters
 - 13 Toggle the unit for displaying the results
- At the end of the measurement:
- 14 Exit drying program:
 - 15 Print measurement report
 - 16 (De)activate, edit GLP parameters
 - 17 Display detailed result
 - 18 Toggle the unit for displaying the results
- 400 W halogen-quartz glass heater

- User guidance in 6 languages (DE, EN, FR, IT, ES, PT)
- Automatic taring when starting a measurement by closing the lid
- The last value measured remains on the display until it is replaced by a new measurement
- 19 Internal GLP; printout of balance ID, project ID, user ID, values determined by the drying process etc.
- 10 sample plates included
- Protective working cover included with delivery
- Application handbook: On the internet, you will find a practical application handbook containing many examples, field reports, settings and tips for each KERN moisture analyser

STANDARD

CAL EXT RS 232 GLP UNIT 230 V DMS 1 DAY

OPTION

DAKKS +3 DAYS

Modell KERN	DLB 160-3A
Readability [d]	0,001 g/0,01 %
Weighing capacity [Max]	160 g
Reproducibility weight of sample 2 g*	0,15 %
Reproducibility, weight of sample 10 g*	0,05 %
Display after drying (Display can be switched over at any time)	
Moisture [%] = Moisture content (M) from wet weight (W)	0-100 %
Dry content [%] = Dry weight (D) from W	100-0 %
ATRO [%] [(W-D) : D] · 100%	0-999 %
Moisture content (M)	Absolute value in [g]
Temperature range	35 °C-160 °C in steps up to 1 °C
Drying modes	<input checked="" type="checkbox"/> Standard drying <input type="checkbox"/> Rapid drying, preheating can be switched on
Switch-off criteria	<ul style="list-style-type: none"> • Automatic unrestricted switch-off (Selectable loss in weight 1 mg/30 s-10 mg/30 s) • Time controlled switch-off (1 min - 99 min) • Manual switch-off at the press of a button
Log output	• Interval adjustable (5 s - 250 s)
Overall dimensions WxDxH	215x345x235 mm
Net weight	approx. 4,7 kg
Price €, excl. of VAT, ex works	1 150,-
Option DAkkS Calibr. Certificate	Mass: KERN 963-127, € 78,-
Option Factory Calibr. Certificate	Temperature: KERN 964-305, € 140,-

* application-dependent

Accessories

- Protective working cover, scope of delivery: 5 items, KERN ALJ-A01S05, € 40,-
- Sample plates aluminium, ø 90 mm, unit of 80 pieces, KERN MLB-A01A, € 45,-
- Round fiberglass filter high mechanical stability, with organic binder, box of 100 pieces, KERN RH-A02, € 80,-
- Round fiberglass filter medium mechanical stability, without organic binder, box of 100 pieces, KERN YMF-A01, € 40,-
- Temperature calibration set consists of measuring sensor and display device, KERN DLB-A01N., € 460,-
- Thermal printer, KERN YKB-01N, € 310,-
- Matrix needle printer, to print the weights on normal paper, ideal for long-term archiving, KERN 911-013, € 390,-

06 Bench scales

Compact industrial weighing technology

Thanks to their compact dimensions, low weight, robust internal mechanism and the fact that they can be operated independent of mains power, bench scales can be used not only in a stationary situation, but also as mobile scales.

With weighing ranges between 3 kg and 65 kg, bench scales can cover a wide range of applications. Whether as a commissioning scale in the warehouse, for inventory purposes, on a production work station, in quality control, in small workshops, in service cars or in sales offices, bench scales are the first choice.

Durable stainless steel weighing plates, easy to read backlit displays, useful functions such as piece counting, PRE-TARE – subtraction of a known container weight, or ► **interfaces** to PC and printer, all these support the users in their daily work.

► **Dual range** scales cover a particularly wide range of applications. With these scales, the total weighing range is divided into 2 subranges and begins with a high resolution read-out in the fine weighing range. If this range is exceeded the balance automatically switches to the higher weighing range with the lower resolution read-out.

All KERN bench scales have an adjustment program (CAL) to adjust the accuracy. In this way, the high level of accuracy is guaranteed at all times, even during harsh everyday use. Find the right test weights for you, see page 184.

Touchscreen balances

The newest development for an even greater level of user-friendliness is the intuitive touchscreen operation, which is being integrated into new KERN models, see page 58/59 (FKT), 108/109 (IKT).

NOTE: a high-quality touchscreen bench scale range (KERN GAT, page 60/61) and touchscreen platform scale range (KERN IFT, page 110/111). Thanks to the intuitive touchscreen concept and multi-lingual operation (DE, EN, IT, ES, PT, NL, FI, PL, RUS, SE, CZ) the balances can be used easily by inexperienced users, straightaway. For the professional user, the balances also provide convenient functions which permit a high level of individualisation and which thereby make operation significantly easier and quicker. Through a large memory, e.g. for item master data, weighing data etc. the balances are the ideal solution when working with a large range of goods or where there are high requirements for record keeping and documentation. Thanks to the high level of connectivity it is easy to connect barcode readers for item recognition, USB sticks for data storage or data transfer to PCs and networks using RS 232 or USB and this means that this range can be used for many different functions in Industry 4.0 applications.

► **See the glossary on page 223–225**

from €
300,-



KERN FKB-A

Page 55

- Simple and convenient 5-key operation
- Very fast display
- High mobility

Quick-Finder Bench scales

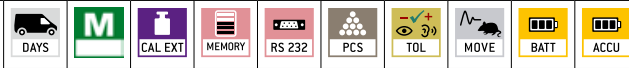
Readability [d] g	Weighing capacity [Max] kg	Weighing plate W×D mm	Model KERN	Price excl. of VAT ex works €	Page										
						For an explanation on the pictos, see front flap									
0,02	6	340×240	FKB 6K0.02	520,-	57	1		●		●	●		●	●	
0,05	6	294×225	GAB 6K0.05N	295,-	56	1		●		●	●	●		●	
0,05	8	340×240	FKB 8K0.05	480,-	57	1		●		●	●		●	●	
0,05	16	340×240	FKB 16K0.05	580,-	57	1		●		●	●		●	●	
0,1	3	253×227	FCB 3K0.1	215,-	54	1		●		●	●		●	●	
0,1	8	253×227	FCB 8K0.1	240,-	54	1		●		●	●		●	●	
0,1	8	340×240	FKB 8K0.1A	350,-	55	1		●		●	●		●	●	
0,1	12	294×225	GAB 12K0.1N	295,-	56	1		●		●	●	●		●	
0,1	16	340×240	FKB 16K0.1	480,-	57	1		●		●	●		●	●	
0,1	36	340×240	FKB 36K0.1	550,-	57	1		●		●	●		●	●	
0,2	30	294×225	GAB 30K0.2N	295,-	56	1		●		●	●	●		●	
0,2	36	340×240	FKB 36K0.2	510,-	57	1		●		●	●		●	●	
0,2	65	340×240	FKB 65K0.2	550,-	57	1		●		●	●		●	●	
0,5	6	253×227	FCB 6K0.5	195,-	54	1		●		●	●		●	●	
0,5	15	340×240	FKB 15K0.5A	350,-	55	1		●		●	●		●	●	
1	3	252×228	FCE 3K1N	110,-	53	1		●					●	●	
1	12	253×227	FCB 12K1	185,-	54	1		●		●	●		●	●	
1	15	340×240	FKB 15K1A	260,-	55	1		●		●	●		●	●	
1	30	253×227	FCB 30K1	220,-	54	1		●		●	●		●	●	
1	30	340×240	FKB 30K1A	300,-	55	1		●		●	●		●	●	
1	65	340×240	FKB 65K1A	320,-	55	1		●		●	●		●	●	
1 2	3 6	295×225	GAB 6K1DNM	225,-	56	1	○	●		●	●		●	●	
2	6	252×228	FCE 6K2N	110,-	53	1		●					●	●	
2	24	253×227	FCB 24K2	185,-	54	1		●		●	●		●	●	
2 5	6 15	300×230	GAB 15K2DNM	225,-	56	1	○	●		●	●		●	●	
5	10	320×260	ECE 10K-3N	95,-	52	1		●					●	●	
5	10	320×260	ECB 10K-3N	110,-	52	1		●					●	●	
5	15	252×228	FCE 15K5N	110,-	53	1		●					●	●	
5 10	15 30	294×225	GAB 30K5DNM	225,-	56	1	○	●		●	●		●	●	
10	20	320×260	ECE 20K-2N	95,-	52	1		●					●	●	
10	20	320×260	ECB 20K-2N	110,-	52	1		●					●	●	
10	30	252×228	FCE 30K10N	110,-	53	1		●					●	●	
20	50	320×260	ECE 50K-2N	95,-	52	1		●					●	●	
20	50	320×260	ECB 50K-2N	110,-	52	1		●					●	●	

● = standard ○ = option

06

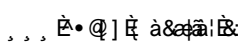



06

Plain, mobile, uncomplicated

Features

- **2** High mobility: Battery operation, compact, lightweight construction, recessed grips on the underside and low weight make this balance ideal for use in several locations
- Particularly large weighing plate
- Very fast display: steady weight values within 2 s
- Simple and convenient 2-key operation

Technical data

- KERN ECB-N: Large backlit LCD display, digit height 21 mm
- KERN ECE-N: Large LCD display, digit height 21 mm
- Dimensions weighing surface W×D 320×260 mm
- Weighing plate material
 - KERN ECE-N: plastic
 - KERN ECB-N: stainless steel, see larger picture
- Overall dimensions W×D×H 320×300×60 mm
- Optional battery operation, 6×1.5 V AA, standard, operating time up to 100 h, AUTO-OFF function to preserve the battery
- Net weight
 - KERN ECE-N: approx. 1,6 kg
 - KERN ECB-N: approx. 2,6 kg
- Permissible ambient temperature 5 °C/35 °C

Accessories

- Internal rechargeable battery pack, operating time up to 30 h without backlight, charging time approx. 10 h, KERN PCB-A01, **€ 75,-**
- Rechargeable battery pack external, operating time up to 30 h without backlight, charging time approx. 10 h, KERN KS-A01, **€ 160,-**
- Tare pan made from stainless steel. Ideal for weighing loose small parts, fruit, vegetables, etc., KERN RFS-A02, **€ 55,-**
- External universal mains adapter, with universal input and optional input socket adapters for EU, GB, USA, KERN YKA-03N, **€ 32,-**
- Further details, plenty of further accessories and suitable printers see *Accessories*

STANDARD				OPTION		
CAL EXT	BATT	DMS	1 DAY	ACCU	MULTI	DAkkS +3 DAYS

Model	Weighing capacity [Max] kg	Readability [d] g	Reproducibility g	Linearity g	Price excl. of VAT ex works €	Option DAkkS Calibr. Certificate	
						DAkkS KERN	€
KERN							
ECE 10K-3N	10	5	5	± 20	95,-	963-128	94,-
ECE 20K-2N	20	10	10	± 40	95,-	963-128	94,-
ECE 50K-2N	50	20	20	± 80	95,-	963-128	94,-
ECB							
ECB 10K-3N	10	5	5	± 20	110,-	963-128	94,-
ECB 20K-2N	20	10	10	± 40	110,-	963-128	94,-
ECB 50K-2N	50	20	20	± 80	110,-	963-128	94,-



06

Entry-level bench scale – mobile, practical, lightweight

Features

- Simple and convenient 2-key operation
- Very fast display: steady weight values within 3 s
- **1** Ideal as a compact letter and parcel scale, especially where space is limited
- **2** Ideal as a grading, commissioning or simple checkweighing scale in production or dispatch
- Protective working cover included with delivery

Technical data

- Large LCD display, digit height 25 mm
- Dimensions weighing surface, plastic, W×D 252×228 mm
- Overall dimensions W×D×H 270×323×110 mm
- Optional battery operation, 9 V block not included in scope of delivery, operating time up to 12 h, AUTO-OFF function to preserve the battery
- Net weight approx. 2,4 kg
- Permissible ambient temperature 5 °C/35 °C

Accessories

- Protective working cover, scope of delivery: 5 pieces, KERN FCB-A02S05, **€ 40,-**
- **1** Stainless steel weighing plate, robust, removable, for easy cleaning, KERN FCE-A01, **€ 35,-**
- Internal rechargeable battery pack, operating time up to 20 h, without backlight, charging time approx. 10 h, KERN FCB-A01, **€ 50,-**

STANDARD: CAL EXT, BATT, MULTI, DMS, 1 DAY

OPTION: ACCU, DAKKS +3 DAYS

Model	Weighing capacity [Max] kg	Readability [d] g	Reproducibility g	Linearity g	Price excl. of VAT ex works €	Option	
						DAKKS KERN	DAKKS Calibr. Certificate €
FCE 3K1N	3	1	2	± 3	110,-	963-127	78,-
FCE 6K2N	6	2	2	± 4	110,-	963-128	94,-
FCE 15K5N	15	5	10	± 15	110,-	963-128	94,-
FCE 30K10N	30	10	10	± 30	110,-	963-128	94,-

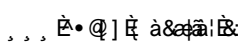



06

Bench scale with second display on the backside of the scale

Features

- **1** Second display on the rear of the balance
- PRE-TARE function for manual subtraction of a known container weight, useful for checking fill-levels
- High mobility: thanks to battery operation/ rechargeable battery operation (optional), compact, lightweight construction, it is suitable for the use in several locations (production, warehouse, dispatch department etc.)
- Data interface RS-232 standard
- Protective working cover included with delivery

Technical data

- Backlit LCD display, digit height 25 mm
- Dimensions of weighing surface, stainless steel, WxD 253x227 mm
- Overall dimensions WxDxH 270x323x110 mm
- Optional battery operation, 9 V block not included in scope of delivery, operating time up to 12 h
- Net weight approx. 2,6 kg
- Permissible ambient temperature 5 °C/35 °C

Accessories

- Protective working cover, scope of delivery: 5 pieces, KERN FCB-A02S05, **€ 40,-**
- Internal rechargeable battery pack, operating time up to 10 h, without backlight, charging time approx. 10 h., KERN FCB-A01, **€ 50,-**
- Further details, plenty of further accessories and suitable printers see *Accessories*

STANDARD OPTION

CAL EXT	RS 232	PCS	RECIPE	PERCENT	UNIT	MOVE	BATT	MULTI	DMS	1 DAY	ACCU	DAKkS

Model	Weighing capacity [Max] kg	Readability [d] g	Reproducibility g	Linearity g	Smallest part weight [Normal] g/piece	Price excl. of VAT ex works €	Option	
							DAKkS KERN	DAKkS Calibr. Certificate €
FCB 3K0.1	3	0,1	0,1	± 0,3	2	215,-	963-127	78,-
FCB 8K0.1	8	0,1	0,1	± 0,3	2	240,-	963-128	94,-
FCB 6K0.5	6	0,5	0,5	± 1,5	10	195,-	963-128	94,-
FCB 12K1	12	1	1	± 3	20	185,-	963-128	94,-
FCB 30K1	30	1	1	± 3	20	220,-	963-128	94,-
FCB 24K2	24	2	2	± 6	40	185,-	963-128	94,-

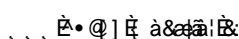



Bench scale up to 65 kg with large weighing plate

Features

- PRE-TARE function for manual subtraction of a known container weight, useful for checking fill-levels
- **1** Particularly practical: thanks to the large weighing ranges and compact dimensions, you can accurately weigh heavy loads in the most restricted of spaces. Useful for determining very small weight differences, such as, for example, gas wastage, abrasion of mechanical parts, rock samples, minerals, druses, silver etc.
- Large, robust weighing plate made from stainless steel, can be removed and therefore is easy to clean
- Freely programmable weighing unit, e.g. display direct in special units such as length of wire g/m, surface weight g/m², or else
- Protective working cover included with delivery

Technical data

- Large backlit LCD display, digit height 25 mm
- Dimensions weighing surface, stainless steel, W×D 340×240 mm
- Overall dimensions W×D×H 348×390×113 mm
- Optional battery operation, 9 V block not included in scope of delivery, operating time up to 12 h
- Net weight approx. 6 kg
- Permissible ambient temperature 5 °C/35 °C

Accessories

- Protective working cover, scope of delivery: 5 items, KERN FKB-A02S05, **€ 40,-**
- Internal rechargeable battery pack, operating time up to 30 h without backlight, charging time approx. 10 h, KERN PCB-A01, **€ 75,-**
- USB data interface, for transferring weighing to the PC, printer etc., must be ordered at purchase, KERN CKE-A02, **€ 65,-**
- WiFi data interface for wireless data transmission from balance to printer, PC or other peripheral devices, must be ordered at purchase, KERN YMI-A01, **€ 90,-**
- Ethernet interface to connect to an IP-based Ethernet network, must be ordered at purchase, KERN FKB-A01, **€ 30,-**
- Tare pan made from stainless steel. Ideal for weighing loose small parts, fruit, vegetables etc. W×D×H 370×240×20 mm, KERN RFS-A02, **€ 55,-**
- Further details, plenty of further accessories and suitable printers see *Accessories*

STANDARD



OPTION

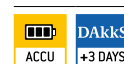

FACTORY

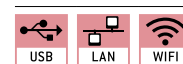

Model	Weighing capacity [Max] kg	Readability [d] g	Reproducibility g	Linearity g	Smallest part weight [Normal] g/piece	Price excl. of VAT ex works €	Option	
							DAkKS KERN	DAkKS Calibr. Certificate €
FKB 8K0.1	8	0,1	0,1	± 0,3	2	350,-	963-128	94,-
FKB 15K0.5	15	0,5	0,5	± 1,5	10	350,-	963-128	94,-
FKB 30K1	30	1	1	± 3	20	300,- ↓	963-128	94,-
FKB 65K1	65	1	1	± 3	20	320,- ↓	963-129	116,-

↓ Price reduction

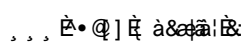



06

Checkweighing and portioning scale, also with EC type approval [M]

Features

- Compact size, practical for small spaces
- High mobility: thanks to rechargeable battery operation (optional), compact, lightweight construction, it is suitable for the use in several locations (production, warehouse, dispatch department etc.)
- Weighing with tolerance range (checkweighing): a visual and audible signal helps with portioning, dispensing or grading
- Totalising of weights
- Protective working cover included with delivery

Technical data

- Large backlit LCD display, digit height 24 mm
- Dimensions weighing surface W×D 295×225 mm
- Overall dimensions W×D×H, 320×345×125 mm
- Net weight approx. 3,0 kg
- Permissible ambient temperature
GAB-N: 0 °C/40 °C
GAB-DNM: -10 °C/40 °C

Accessories

- Protective working cover, scope of delivery: 5 items, KERN CFS-A02S05, € 40,-
- Internal rechargeable battery pack, operating time up to 90 h without backlight, charging time approx. 12 h, KERN GAB-A04, € 40,-
- Signal lamp for visual support of weighing with tolerance range, only in combination with, KERN CFS-A03, € 250,-

- Y-cable for parallel connection of two terminal devices to the RS-232 interface on the scale, e.g. signal lamp and printer, KERN CFS-A04, € 35,-
- Tare pan made from stainless steel. Ideal for weighing loose small parts, fruit, vegetables, etc., KERN RFS-A02, € 55,-
- Further details, plenty of further accessories and suitable printers see *Accessories*

Application examples

- Small industrial scale for pharmacies
- Hand mixtures of tea, coffee, chocolates
- Portioning of dough, meat, fish, poultry, mixed salads in cafeterias etc.
- Mobile weighing of freshly picked fruit on site
- Checkweigher in supermarkets
- High-precision industrial applications, piece counting or stock-taking

Note: Official verification duty for commercial trade

STANDARD

CAL EXT ET RS 232 PCS SUM PERCENT UNIT TOL MULTI DMS 1 DAY

OPTION

ACCU DAKKS +3 DAYS

FACTORY

M +3 DAYS GAB-DNM *

Model	Weighing capacity [Max] kg	Readability [d] g	Verification value [e] g	Minimal load [Min] g	Smallest part weight [Normal] g/piece	Price excl. of VAT ex works €	Option			
							Verification	€	DAKKS Calibr. Certificate	€
KERN								€	DAKKS KERN	€
GAB 6K0.05N	6	0,05	-	-	0,5	295,-	-	-	963-128	94,-
GAB 12K0.1N	12	0,1	-	-	1	295,-	-	-	963-128	94,-
GAB 30K0.2N	30	0,2	-	-	2	295,-	-	-	963-128	94,-
Dual-range balance switches automatically to the next largest weighing capacity [Max] and readability [d]										
Note: For applications that require verification, please order verification at the same time, initial verification at a later date is not possible.										
Verification at the factory, we need to know the full address of the location of use.										
GAB 6K1DNM	3 6	1 2	1 2	20	2	225,-	965-228	70,-	963-128	94,-
GAB 15K2DNM	6 15	2 5	2 5	40	5	225,-	965-228	70,-	963-128	94,-
GAB 30K5DNM	15 30	5 10	5 10	100	10	225,-	965-228	70,-	963-128	94,-

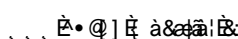



Large, high resolution bench scale

Features

- Thanks to the high resolution of up to 360.000 points it is ideal for high-precision weighing in the industrial field
- Housing with robust aluminium diecast housing trough, maintains the stability, protects the weighing technology elements and is robust enough to cope with everyday use
- **I** Particularly practical: thanks to the large weighing ranges and compact dimensions, you can accurately weigh heavy loads in the most restricted of spaces. Useful for determining very small weight differences, such as, for example, gas wastage, abrasion of mechanical parts, rock samples, minerals, druses, silver etc.
- PRE-TARE function for manual subtraction of a known container weight, useful for checking fill-levels
- Freely programmable weighing unit, e.g. display direct in special units such as length of wire g/m, surface weight g/m², or else

- Model with resolution > 240,000 Pt.: Level indicator and levelling feet for precise levelling of the scale, fitted as standard
- Protective working cover included with delivery

Technical data

- Backlit LCD display, digit height 18 mm
- Dimensions weighing surface, stainless steel, WxD 340x240 mm
- Dimensions housing WxDxH, 350x390x120 mm
- Optional battery operation, 6x1.5 V Size C not included in scope of delivery, operating time up to 40 h
- Net weight approx. 7 kg
- Permissible ambient temperature 10 °C/40 °C

Accessories

- Protective working cover, scope of delivery: 5 items, KERN FKB-A02S05, **€ 40,-**
- Rechargeable battery pack external, operating time up to 30 h without backlight, charging time approx. 10 h, KERN KS-A01, **€ 160,-**
- USB data interface, for transferring weighing to the PC, printer etc., must be ordered at purchase, KERN CKE-A02, **€ 65,-**
- WiFi data interface for wireless data transmission from balance to printer, PC or other peripheral devices, must be ordered at purchase, KERN YMI-A01, **€ 90,-**
- Ethernet interface to connect to an IP-based Ethernet network, must be ordered at purchase, KERN FKB-A01, **€ 30,-**
- Tare pan made from stainless steel. Ideal for weighing loose small parts, fruit, vegetables etc. WxDxH 370x240x20 mm, KERN RFS-A02, **€ 55,-**
- Further details, plenty of further accessories and suitable printers see *Accessories*

STANDARD



OPTION

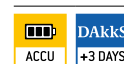

FACTORY

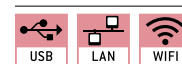

Model	Weighing capacity [Max] kg	Readability [d] g	Reproducibility g	Linearity g	Smallest part weight [Normal] g/piece	Price excl. of VAT ex works €	Option	
							DAkkS KERN	Certificate €
FKB 6K0.02	6	0,02	0,04	± 0,1	0,2	520,-	963-128	94,-
FKB 8K0.05	8	0,05	0,05	± 0,15	0,5	480,-	963-128	94,-
FKB 16K0.05	16	0,05	0,1	± 0,25	0,5	580,-	963-128	94,-
FKB 16K0.1	16	0,1	0,1	± 0,3	1	480,-	963-128	94,-
FKB 36K0.1	36	0,1	0,2	± 0,5	1	550,-	963-128	94,-
FKB 36K0.2	36	0,2	0,2	± 0,6	2	510,-	963-128	94,-
FKB 65K0.2	65	0,2	0,4	± 1	2	550,-	963-129	116,-

TIPS FROM THE EXPERTS

As well as our balances and test services, we can offer you an extensive range of professional measuring technology and testing technology as a comprehensive range of test services.

We will offer you reliable quality at fair prices and with the shortest delivery times. Our product specialists will give you professional advice, will work with you to find the right product and will provide comprehensive support after the purchase too.

For all details on our ranges, please see www.kern-sohn.com or request your own personal catalogues right now: Telephone +49 7433 9933-0

“New: High-quality load cells for force and mass measurement”

Accuracy classes with rated loads from 300g to 50t and protection classes up to IP69K are now available in the SAUTER product range. For which project whatsoever, whether to build individual weighing systems, for installation in silos and storage containers or shelves for continuous inventory, for special applications in mechanical engineering or any kind of test stands – SAUTER offers a suitable measuring cell.

Of course, we also supply the right accessories, such as load corners, rod ends, evaluation units, junction box or the appropriate calibration certificate.

Special wishes? Special load cells, other capacities or cable lengths, individual dynamometers or a special receptacle for your test object? No problem, our product specialist “Load cells”, Mr. Stefan Herrman, will be pleased to help you at any time and work with you to develop an individual concept for your application.

All load cells and measuring instruments can be found in the new SAUTER catalogue 2021 for measuring technology and test services



Stefan Herrmann, Product Manager
SAUTER measuring equipment

BALANCE MANUFACTURE

Load cell + Junction Box + KERN YKV



BALANCE MANUFACTURE

Load cell + display device



FORCE MEASUREMENT

Load cell + SAUTER FL + Software



BALANCE MANUFACTURE

Load cell + KERN YKV + KERN Software BalanceConnection



BALANCE MANUFACTURE

Load cell + Junction Box + display device

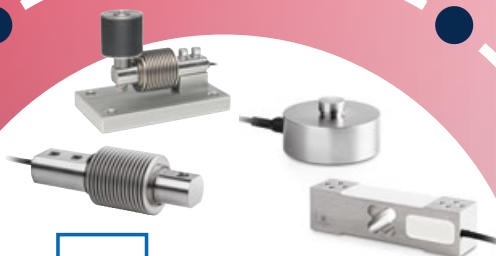

SAUTER Mess measuring cells – integration opportunities

Food (kitchen/stainless steel/IP65...68 protection)

KERN scales – not scared of water at all!

Scales used in industrial situations or the food industry are often exposed to extreme stresses and strains. Water, oils, fats, varnish, dust, dirt, flour, small parts etc. are all natural enemies of a scale. In industries such as the chemical, pharmaceutical, food, manufacturing industries, etc. scales must be able to cope with these stresses without this affecting their performance.





For use in such harsh environmental conditions, levels of protection are defined, which specify which environmental stresses a system can be exposed to with respect to the level of contact, foreign object and moisture protection, without damage being caused to the unit. These levels of protection are described in the following standard: "DIN EN 60529: protection types through housing" The IP code usually consists of a two-digit combination, which gives the relevant level of protection, e.g. IP68.

The first digit specifies the protection level for contact protection and protection against foreign bodies (dust protection), the second digit is for the water and moisture protection (protection against splashes of water).

All stainless steel components of the IP65...68 protected KERN stainless steel scales are made of corrosion-resistant steel of quality class 1.4301 (DIN X5CrNi18-10). The material properties support you in your ► **HACCP**-compliant quality system.

► See the glossary on page 223–225

Extract from the standard: "DIN EN 60529: protection types through housing":

KERN-Pictogram	1. digit	Specification	2. digit	Specification
	6	Dustproof	5	Protection against jets of water (nozzle) from any angle (cleaning with a damp cloth)
	6	Dustproof	6	Protection against powerful jets of water
	6	Dustproof	7	Protection against temporary immersion
	6	Dustproof	8	Protection against continuous immersion (designed for continuous use in wet areas, submersion is possible depending on the pressure (water depth))

KERN FGE 10K-3S05

Page 61

- Weighing plate made of safety glass
- For easy and hygienic cleaning
- Low overall height for secure footing and space-saving storage
- Large high-contrast display that is easy to read

only €
30,-*

* Price set of 5 units
excl. of VAT ex works



Quick-Finder Food (kitchen/stainless steel/IP65...68 protection)

Readability [d] g	Weighing capacity [Max] kg	Model KERN	Price excl. of VAT ex works €	Page										
For an explanation on the pictos, see front flap														
0,1	0,5	FOB 500-1S	79,-	63	1									
0,1	0,5	FOB 0.5K-4NS	105,-	64	1									
0,1	3	FCF 3K-4	185,-	62	1									
0,2	1,5	WTB 1K-4N	215,-	68	1									
0,2	1,5	FFN 1K-4N	260,-	68	1									
0,2	3	FOB 3K-4NL	265,-	67	1									
0,5	1,5	FOB 1.5K0.5	180,-	65	1									
0,5	1,5	FOB 1K-4LM	265,-	66	1									
0,5	1,5	WTB 1K-4NM	235,-	68	1									
0,5	1,5	FFN 1K-4NM	285,-	68	1									
0,5	3	WTB 3K-4N	215,-	68	1									
0,5	3	FFN 3K0.5IPN	255,-	68	1									
0,5	3	FXN 3K-4N	305,-	70	1									
0,5 1	5 7,5	FOB 7K-4NL	230,-	67	1									
1	3	FOB 3K1	180,-	65	1									
1	3	FOB 3K-3LM	265,-	66	1									
1	3	WTB 3K-3NM	235,-	68	1									
1	3	FFN 3K1IPM	285,-	68	1									
1	3	FXN 3K-3M	370,-	70	1									
1	5	FGE 5K-3S05	99,-*	61	1									
1	5	FOB 5K1S	79,-	63	1									
1	5	FOB 5K-3NS	105,-	64	1									
1	6	WTB 6K-3N	215,-	68	1									
1	6	FFN 6K1IPN	255,-	68	1									
1	6	FXN 6K-3N	305,-	70	1									
1	10	SFB 10K1HIP	670,-	72	1									
1	15	FGE 10K-3S05	150,-*	61	1									
1	30	FCF 30K-3	185,-	62	1									
1 2	3 6	SXS 6K-3M	700,-	71	1									
1 2	8 15	FOB 10K-3NL	230,-	67	1									
2	6	FOB 6K2	180,-	65	1									
2	6	FOB 6K-3LM	265,-	66	1									
2	6	WTB 6K-3NM	235,-	68	1									
2	6	FFN 6K2IPM	285,-	68	1									
2	6	FXN 6K-3M	370,-	70	1									
2	15	WTB 10K-3N	215,-	68	1									
2	15	FFN 15K2IPN	255,-	68	1									
2	15	FXN 10K-3N	305,-	70	1									
2	20	SFB 20K2HIP	670,-	72	1									
2 5	6 15	SXS 10K-3M	700,-	71	1									
2 5	6 15	SXS 10K-3LM	905,-	71	1									
2 5	16 30	FOB 30K-3NL	230,-	67	1									
5	15	FOB 10K-3LM	265,-	66	1									
5	15	WTB 10K-3NM	235,-	68	1									
5	15	FFN 15K5IPM	285,-	68	1									
5	15	FXN 10K-3M	370,-	70	1									
5	15	SFB 15K5HIPM	680,-	72	1									
5	25	FFN 25K5IPN	255,-	68	1									
5	30	WTB 30K-3N	215,-	68	1									
5	30	FXN 30K-3N	305,-	70	1									
5	50	SFB 50K-3XL	830,-	72	1									
5	50	SFB 50K5HIP	670,-	72	1									
5	50	SFB 50K5LHIP	710,-	72	1									
5 10	15 30	SXS 30K-2M	905,-	71	1									
5 10	15 30	SXS 30K-2LM	1120,-	71	1									
10	25	FFN 25K10IPM	285,-	68	1									
10	30	WTB 30K-2NM	235,-	68	1									
10	30	FXN 30K-2M	370,-	70	1									
10	30	SFB 30K10HIPM	690,-	72	1									
10	100	SFB 100K10HIP	730,-	72	1									
10	100	SFB 100K-2XL	1130,-	72	1									
10 20	30 60	SXS 60K-2M	915,-	71	1									
10 20	30 60	SXS 60K-2LM	1120,-	71	1									
20	60	SFB 60K-2XLM	930,-	72	1									
20	60	SFB 60K20LHIPM	740,-	72	1									
20 50	60 150	SXS 100K-2M	1120,-	71	1									
20 50	60 150	SXS 100K-2LM	1370,-	71	2**									
50	150	SFB 100K-2HM	760,-	72	1									
50	150	SFB 100K-2XLM	1150,-	72	1									
50 100	150 300	SXS 300K-2M	1370,-	71	2**									

News 2021 * Price set of 5 units ** Shipment via freight forwarder. Please ask for dimensions, gross weight, shipping costs ● = standard ○ = option

NEW 5x



1 FGE 5K-3S05

2 FGE 10K-3S05

The price breaker!
 Cheapest kitchen scale in the KERN assortment
 from € **19,80****

** unit price within the set of 5, excl. of VAT ex works

Precise design kitchen scale for kitchen, canteen, gastronomy

Features

- FGE 10K-3: Weighing plate made out of safety glass
- hygienic and easy to clean
- Low overall height for secure footing and space-saving storage
- Secure and non-slip positioning through rubber feet
- Very easy to use
 FGE 5K-3S05: 2 Buttons
 FGE 10K-3S05: 1 Button
- Comfortable taring with just one keystroke. For example, you can tare a bowl before starting a formulation. In addition, you can tare each time you weigh in a formulation ingredient, so that you can weigh in the next formulation ingredient with the weight indicated in the formula without having to do any calculations
- Integrated AUTO-OFF function to preserve the batteries
- 3 Large high-contrast display that is easy to read

Technical data

- 1 FGE 5K-3S05
 - Large backlit LCD display, digit height 18 mm
 - Overall dimensions W×D×H 152×230×15 mm
 - Dimensions of glass weighing plate W×D 152×230 mm
 - Ready for use: Batteries included, operating time up to 144 h
- 2 FGE 10K-3S05
 - Large backlit LED display, digit height 22 mm
 - Overall dimensions W×D×H 272×250×22 mm
 - Dimensions of glass weighing plate W×D 272×205 mm
 - Ready for use: Batteries included, operating time up to 300 h
 - 3 Delivered in appealing packaging
- **Note:** The models are delivered in a set of 5 units. i.e. the price given in the table refers to 5 items. Cannot be delivered individually. The calibration price refers to one single balance

STANDARD OPTION

CAL EXT
 UNIT
 BATT
 DMS
 1 DAY
 DAkKS +3 DAYS

Model	Weighing capacity [Max] kg	Readability [d] g	Price excl. of VAT ex works €	Option	
				DAkKS KERN	Calibr. Certificate €
FGE 5K-3S05	5	1	99,-*	963-127	78,-
FGE 10K-3S05	15	1	150,-*	963-128	94,-

* Price set of 5 units



07

Compact bench scale with multi-purpose functionality and a high level of accuracy for use in industry, gastronomy and kitchen

Features

- Simple and convenient 5-key operation
- Very fast display: steady weight values within 3 s
- Ideal as a
 - compact letter and parcel scale, especially in constricted spaces
 - grading or commissioning balance or simple checkweigher in production or dispatch
 - Checkweigher in the catering trade, cafeterias, school kitchens
- High mobility: thanks to battery operation/rechargeable battery operation (optional), compact, lightweight construction, it is suitable for the use in several locations (production, warehouse, dispatch department etc.)
- Protective working cover included with delivery

Technical data

- Large backlit LCD display, digit height 25 mm
- Dimensions weighing surface, stainless steel, WxD 253x228 mm
- Overall dimensions WxDxH 270x345x106 mm
- Optional battery operation, 9 V block not included in scope of delivery, operating time up to 20 h, AUTO-OFF function to preserve the battery
- Net weight approx. 2,8 kg
- Permissible ambient temperature 5 °C/35 °C

Accessories

- Protective working cover, scope of delivery: 5 items, KERN FCF-A01S05, € 40,-
- Internal rechargeable battery pack, operating time up to 120 h without backlight, charging time approx. 16 h, KERN GAB-A04, € 40,-

STANDARD



OPTION



Model	Weighing capacity [Max] kg	Readability [d] g	Reproducibility g	Linearity g	Smallest part weight [Normal] g/piece	Price excl. of VAT ex works €	Option	
							DAkks KERN	Certificate €
FCF 3K-4	3	0,1	0,1	± 0,3	2	185,-	963-127	78,-
FCF 30K-3	30	1	1	± 3	20	185,-	963-128	94,-



Super compact stainless steel balance for weighing, checking and portioning in the smallest of spaces

07

Features

- Stainless steel design of the housing and weighing plate. Its smooth surfaces make it simple to clean
- High mobility: thanks to battery operation, compact, lightweight construction, it is suitable for the use in several locations (kitchen, sales office, cafeteria, Food industry-Laboratory etc.)
- Secure and non-slip positioning through rubber feet
- Your support in a HACCP-compliant quality system
- Particularly flat design
- Protective working cover included with delivery

Technical data

- Large LCD display, digit height 20 mm
- Dimensions weighing surface, stainless steel, WxD 125x155 mm
- Overall dimensions WxDxH 175x155x40 mm
- Ready for use: Batteries included, 9 V block, operating time up to 20 h
- Net weight approx. 0,70 kg
- Permissible ambient temperature 10 °C/40 °C

Accessories

- **1** Protective working cover, scope of delivery: 5 items, KERN FOB-A11S05, **€ 50,-**
- External mains adapter, KERN FOB-A09, **€ 35,-**

STANDARD					OPTION	
CAL EXT	UNIT	BATT	DMS	1 DAY	230 V	DAkkS +3 DAYS

Model	Weighing capacity [Max] kg	Readability [d] g	Weighing plate WxD mm	Price excl. of VAT ex works €	Options	
					DAkkS KERN	DAkkS Calibr. Certificate €
KERN FOB 500-1S	0,5	0,1	155x125	79,-	963-127	78,-
FOB 5K1S	5	1	155x125	79,-	963-127	78,-

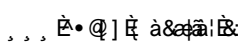



07 Super compact stainless steel balance with protection type IP65 against dust and water splashes

Features

- Stainless steel design of the housing and weighing plate. Its smooth surfaces make it simple to clean
- High mobility: thanks to battery operation, compact, lightweight construction, it is suitable for the use in several locations (kitchen, sales office, cafeteria, Food industry-Laboratory etc.)
- Secure and non-slip positioning through rubber feet
- Your support in a HACCP-compliant quality system
- Particularly flat design
- Protection against dust and water splashes IP65 (only when using battery)
- Protective working cover included with delivery

Technical data

- Large LCD display, digit height 20 mm
- Dimensions weighing surface, stainless steel, WxD 150x120 mm
- Overall dimensions WxDxH 170x150x40 mm
- Ready for use: Batteries included, 9 V block, operating time up to 24 h
- Net weight 0,80 kg
- Permissible ambient temperature 10 °C/40 °C

Accessories

- **1** Protective working cover, scope of delivery: 5 items, KERN FOB-A12S05, **€ 40,-**
- External mains adapter, KERN FOB-A09, **€ 35,-**

STANDARD						OPTION	

Model	Weighing capacity [Max] kg	Readability [d] g	Weighing plate WxD mm	Price excl. of VAT ex works €	Options	
					DAkkS KERN	DAkkS Calibr. Certificate €
KERN						
FOB 0.5K-4NS	0,5	0,1	150x120	105,-	963-127	78,-
FOB 5K-3NS	5	1	150x120	105,-	963-127	78,-

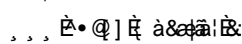



Compact stainless steel bench scale with special checkweighing display for even more efficient working

07

Features

- **1** Innovative weighing with tolerance range (Checkweighing): The colour of the display changes depending on the weight (too light/ok/too heavy) and is an aid to help with portioning, dosing and grading
- Stainless steel design of the housing and weighing plate. Its smooth surfaces make it simple to clean
- High mobility: thanks to battery operation, compact, lightweight construction, it is suitable for the use in several locations (kitchen, sales office, cafeteria, Food industry-Laboratory etc.)
- Your support in a HACCP-compliant quality system
- Secure and non-slip positioning through rubber feet
- Increased protection against humidity through waterproof silicone sealing of the load cell, electronics and soldering joints
- Check the weighing capacity which is in use at the press of a button (net/gross weight)
- Protective working cover included with delivery

Technical data

- Large backlit LCD display, digit height 20 mm
- Overall dimensions W×D×H 240×180×60 mm
- Net weight approx. 2,0 kg
- Permissible ambient temperature 5 °C/35 °C

Accessories

- **2** Protective working cover, scope of delivery: 5 items, KERN FOB-A05S05, **€ 40,-**
- Internal rechargeable battery pack, operating time up to 24 h without backlight, charging time approx. 8 h, KERN FOB-A07, **€ 45,-**
- **3** Tare pan made from stainless steel, ideal for weighing loose small parts, fruit, vegetables, etc., KERN RFS-A02, **€ 55,-**

STANDARD

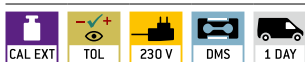

OPTION

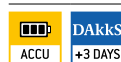

Model	Weighing capacity [Max] kg	Readability [d] g	Weighing plate mm	Price excl. of VAT ex works €	Option	
					DAkkS KERN	DAkkS Calibr. Certificate €
FOB 1.5K0.5	1,5	0,5	175×165	180,-	963-127	78,-
FOB 3K1	3	1	175×165	180,-	963-127	78,-
FOB 6K2	6	2	175×165	180,-	963-128	94,-



07 Compact stainless steel bench scale with EC type approval [M] and special checkweighing display for even more efficient working

Features

- **1** Innovative weighing with tolerance range (Checkweighing): The colour of the display changes depending on the weight (too light/ok/too heavy) and is an aid to help with portioning, dosing and grading
- Stainless steel design of the housing and weighing plate. Its smooth surfaces make it simple to clean
- **2** Suitable for the ever-increasing hygienic requirements in the food industry
- High mobility: thanks to battery operation, compact, lightweight construction, it is suitable for the use in several locations (kitchen, sales office, cafeteria, Food industry-Laboratory etc.)
- Your support in a HACCP-compliant quality system
- Protection against dust and water splashes IP67 (only when using battery)
- Secure and non-slip positioning through rubber feet
- Increased protection against humidity through waterproof silicone sealing of the load cell, electronics and soldering joints

- Check the weighing capacity which is in use at the press of a button (net/gross weight)
- Mains adapter included with the delivery
- Protective working cover included with delivery

Technical data

- Large backlit LCD display, digit height 25 mm
- Overall dimensions W×D×H 256×285×100 mm
- KERN FOB-LM: Optional battery operation, 4×1.5 V AA, standard, operating time up to 48 h, AUTO-OFF function to preserve the battery
- Net weight 3,8 kg
- Permissible ambient temperature 5 °C/35 °C

Accessories

- **3** Protective working cover, scope of delivery: 5 items, KERN FOB-A13S05, **€ 40,-**
- Mains adapter external, not included, can be reordered, KERN FOB-A01, **€ 35,-**
- **4** Tare pan made from stainless steel, ideal for weighing loose small parts, fruit, vegetables, etc., KERN RFS-A02, **€ 55,-**



Model	Weighing capacity [Max] kg	Readability [d] g	Verification value [e] g	Minimal load [Min] g	Weighing plate mm	Price excl. of VAT ex works €	Option			
							Verification		DAKKS Calibr. Certificate	
							M KERN	€	DAKKS KERN	€
FOB 1K-4LM	1,5	0,5	0,5	10	248×198	265,-	965-227	55,-	963-127	78,-
FOB 3K-3LM	3	1	1	20	248×198	265,-	965-227	55,-	963-127	78,-
FOB 6K-3LM	6	2	2	40	248×198	265,-	965-228	70,-	963-128	94,-
FOB 10K-3LM	15	5	5	100	248×198	265,-	965-228	70,-	963-128	94,-

Note: For applications that require verification, please order verification at the same time, initial verification at a later date is not possible. Verification at the factory, we need to know the full address of the location of use.

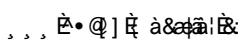



Stainless steel bench scale with large weighing ranges and IP67 protection against dust and water spray

Features

- Stainless steel design of the housing and weighing plate. Its smooth surfaces make it simple to clean
- **1** Ideal for the increased hygienic requirements in the food industries
- Your support in a HACCP-compliant quality system
- **4** Protection against dust and water splashes IP67 (only when using battery)
- High mobility: thanks to battery operation, compact, lightweight construction, it is suitable for the use in several locations (kitchen, salesroom cafeteria, Food industry-Laboratory etc.)
- Protective working cover included with delivery

Technical data

- Large backlit LCD display, digit height 25 mm
- Overall dimensions W×D×H 285×255×90 mm
- Ready for use: Batteries included, 4×1.5 V AA, operating time up to 48 h
- Net weight approx. 3,8 kg
- Permissible ambient temperature 5 °C/35 °C

Accessories

- **2** Protective working cover, scope of delivery: 5 items, KERN FOB-A13S05, **€ 40,-**
- Mains adapter external, not included, KERN FOB-A01, **€ 35,-**
- **3** Tare pan made of stainless steel, ideal for weighing loose small parts, fruit, vegetables etc., W×D×H 370×240×20mm, KERN RFS-A02, **€ 55,-**

STANDARD: CAL EXT, UNIT, IP 67, BATT, DMS, 1 DAY

OPTION: 230 V, DAKKS +3 DAYS

Model	Weighing capacity [Max] kg	Readability [d] g	Weighing plate W×D mm	Price excl. of VAT ex works €	Option	
					DAkKS KERN	DAkKS Calibr. Certificate €
FOB 3K-4NL	3	0,2	252×200	265,-	963-127	78,-
Dual-range balance switches automatically to the next largest weighing capacity [Max] and readability [d]						
FOB 7K-4NL	5 7,5	0,5 1	252×200	230,-	963-128	94,-
FOB 10K-3NL	8 15	1 2	252×200	230,-	963-128	94,-
FOB 30K-3NL	16 30	2 5	252×200	230,-	963-128	94,-

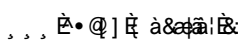



07

Ideal for food industry, thanks to its IP65 protection and special checkweighing display, now also with EC type approval [M]

Features

- Suitable for the ever-increasing hygienic requirements in the food industry
- Your support in a HACCP-compliant quality system
- 1 Protection against dust and water splashes IP65 (only when using rechargeable battery pack)
- Very fast display: steady weight values within 2 s
- 2 Second display on the rear of the balance
- Compact size, practical for small spaces
- 3 Innovative weighing with tolerance range (Checkweighing): The colour of the display changes depending on the weight (too light/ok/too heavy) and is an aid to help with portioning, dosing and grading

- High mobility: thanks to rechargeable battery operation (optional), compact, lightweight construction, it is suitable for the use in several locations
- Recessed grips on the underside of the scale for easy transportation
- Protective working cover included with delivery

Technical data

- Large backlit LCD display, digit height 25 mm
- Weighing plate dimensions, stainless steel, WxD 260x200 mm
- Overall dimensions WxDxH 285x315x128 mm
- Net weight approx. 3,2 kg
- Permissible ambient temperature -10 °C/40 °C

Accessories

- Protective working cover, scope of delivery: 5 items, KERN RFB-A01S05, € 40,-
- Internal rechargeable battery pack, operating time up to 50 h without backlight, charging time approx. 12 h, KERN WTB-A01N, € 35,-
- 4 Tare pan made from stainless steel, ideal for weighing loose small parts, fruit, vegetables, etc 370x240x20 mm, KERN RFS-A02, € 55,-

STANDARD



OPTION



FACTORY



Model	Weighing capacity [Max] kg	Readability [d] g	Verification value [e] g	Minimal load [Min] g	Price excl. of VAT ex works €	Option			
						Verification		DAkkS Calibr. Certificate	
						M KERN	€	DAkkS KERN	€
WTB 1K-4N	1,5	0,2	-	-	215,-	-	-	963-127	78,-
WTB 3K-4N	3	0,5	-	-	215,-	-	-	963-127	78,-
WTB 6K-3N	6	1	-	-	215,-	-	-	963-128	94,-
WTB 10K-3N	15	2	-	-	215,-	-	-	963-128	94,-
WTB 30K-3N	30	5	-	-	215,-	-	-	963-128	94,-

Note: For applications that require verification, please order verification at the same time, initial verification at a later date is not possible. Verification at the factory, we need to know the full address of the location of use.

WTB 1K-4NM	1,5	0,5	0,5	10	235,-	965-227	55,-	963-127	78,-
WTB 3K-3NM	3	1	1	20	235,-	965-227	55,-	963-127	78,-
WTB 6K-3NM	6	2	2	40	235,-	965-228	70,-	963-128	94,-
WTB 10K-3NM	15	5	5	100	235,-	965-228	70,-	963-128	94,-
WTB 30K-2NM	30	10	10	200	235,-	965-228	70,-	963-128	94,-

Price reduction

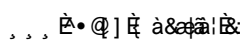



All-round bench scale, protected by stainless steel and IP65 rating, also with EC type approval [M]

Features

- **1** Ideal for the ever-increasing hygienic requirements in the food, pharmaceutical and chemical industries
- Your support in a HACCP-compliant quality system
- **2** Ideal for the robust industrial applications
- **3** Protection against dust and water splashes IP65 (only when using rechargeable battery pack)
- High mobility: thanks to rechargeable battery operation, compact, lightweight construction, it is suitable for the use in several locations (kitchen, sales office, cafeteria, Food industry-Laboratory etc.)
- Stainless steel design of the housing and weighing plate. Its smooth surfaces make it simple to clean
- Recessed grips on the underside of the scale for easy transportation

Technical data

- Large backlit LCD display, digit height 25 mm
- Dimensions weighing surface, stainless steel, WxD 230x190 mm
- Overall dimensions WxDxH 230x300x130 mm
- Internal rechargeable battery pack, operating time up to 50 h without backlight, charging time approx. 12 h
- Net weight approx. 4,0 kg
- Permissible ambient temperature
KERN FFN-N: 0 °C/40 °C
KERN FFN-NM: -10 °C/40 °C

Accessories

- Tare pan made from stainless steel. Ideal for weighing loose small parts, fruit, vegetables, etc., KERN RFS-A02, € 55,-

STANDARD

CAL EXT UNIT IP 65 ACCU MULTI DMS 1 DAY

OPTION FACTORY

DAkkS +3 DAYS M +3 DAYS

Model	Weighing capacity [Max] kg	Readability [d] g	Verification value [e] g	Minimal load [Min] g	Price excl. of VAT ex works €	Option			
						Verification		DAkkS Calibr. Certificate	
						M KERN	€	DAkkS KERN	€
FFN 1K-4N	1,5	0,2	-	-	260,-	-	-	963-127	78,-
FFN 3K0.5IPN	3	0,5	-	-	255,-	-	-	963-127	78,-
FFN 6K1IPN	6	1	-	-	255,-	-	-	963-128	94,-
FFN 15K2IPN	15	2	-	-	255,-	-	-	963-128	94,-
FFN 25K5IPN	25	5	-	-	255,-	-	-	963-128	94,-
Note: For applications that require verification, please order verification at the same time, initial verification at a later date is not possible. Verification at the factory, we need to know the full address of the location of use.									
FFN 1K-4NM	1,5	0,5	0,5	10	285,-	965-227	55,-	963-127	78,-
FFN 3K1IPM	3	1	1	20	285,-	965-227	55,-	963-127	78,-
FFN 6K2IPM	6	2	2	40	285,-	965-228	70,-	963-128	94,-
FFN 15K5IPM	15	5	5	100	285,-	965-228	70,-	963-128	94,-
FFN 25K10IPM	25	10	10	200	285,-	965-228	70,-	963-128	94,-



Robust, space-saving bench scale, protected by stainless steel and IP68 rating – also with EC type approval [M]

Features

- Suitable for the ever-increasing hygienic requirements in the food industry
- Your support in a HACCP-compliant quality system
- Ideal for the robust industrial applications
- Very high class of protection against dust and water IP68, ideal for harsh ambient conditions. Submersion in water actually possible
- Particularly suitable to determine the specific weight of organs, tissues, etc. in Pathology or in the laboratory
- Stainless steel design of the housing and weighing plate. Its smooth surfaces make it simple to clean
- Very fast display: steady weight values within 2 s
- High mobility: thanks to battery operation, compact, lightweight construction, it is suitable for the use in several locations
- Recessed grips on the underside of the scale for easy transportation

- Weighing with tolerance range (checkweighing): a visual and audible signal helps with portioning, dispensing or grading

Technical data

- Large backlit LCD display, (FXN-M: green) digit height 25 mm
- Dimensions weighing surface, stainless steel, WxD 236x195 mm
- Overall dimensions WxDxH 240x280x120 mm
- Ready for use: Batteries included, 4x1.5 V Size D, Operating time without backlight FXN-N up to 200 h, FXN-M 500 h, AUTO-OFF function to preserve the battery
- Net weight 3,2 kg
- Permissible ambient temperature -10 °C/40 °C

Accessories

- Tare pan made from stainless steel. Ideal for weighing loose small parts, fruit, vegetables, etc. WxDxH 370x240x20 mm, KERN RFS-A02, € 55,-

Note: Official verification duty for commercial trade

STANDARD

OPTION FACTORY

Model	Weighing capacity [Max] kg	Readability [d] g	Verification value [e] g	Minimal load [Min] g	Smallest part weight [Normal] g/piece	Price excl. of VAT ex works €	Option			
							Verification		DAkkS Calibr. Certificate	
KERN						KERN	€	DAkkS KERN	€	
FXN 3K-4N	3	0,5	-	-	5	305,-	-	-	963-127	78,-
FXN 6K-3N	6	1	-	-	10	305,-	-	-	963-128	94,-
FXN 10K-3N	15	2	-	-	20	305,-	-	-	963-128	94,-
FXN 30K-3N	30	5	-	-	50	305,-	-	-	963-128	94,-
Note: For applications that require verification, please order verification at the same time, initial verification at a later date is not possible. Verification at the factory, we need to know the full address of the location of use.										
FXN 3K-3M	3	1	1	20	5	370,-	965-227	55,-	963-127	78,-
FXN 6K-3M	6	2	2	40	10	370,-	965-228	70,-	963-128	94,-
FXN 10K-3M	15	5	5	100	20	370,-	965-228	70,-	963-128	94,-
FXN 30K-2M	30	10	10	200	50	370,-	965-228	70,-	963-128	94,-

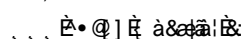



Stainless steel platform scales with IP65/67 protection, also with XL platform or EC type approval [M]

Features

- Ideal for the robust industrial applications
- **1** Platform: made entirely of stainless steel, silicone-coated Stainless Steel load cell, protection against dust and water splashes IP67
- **2** Display device: Stainless steel, protection against dust and water splashes IP65, (only when using rechargeable battery pack)
- **3** SFB-H: Column, standard, for models with weighing plate size
300×240 mm: Height of stand approx. 200 mm
400×300 mm: Height of stand approx. 400 mm

Technical data

- Large backlit LCD display, digit height 52 mm
- Dimensions of display device W×D×H 266×165×96 mm
- Cable length of display device approx. 3 m
- Internal rechargeable battery pack, operating time up to 35 h without backlight, charging time approx. 12 h
- Permissible ambient temperature -10 °C/40 °C

Accessories

- Data interface RS-232, interface cable included, approx. 1,5 m, must be ordered at purchase, RS 232 data interface including interface cable, KERN KFN-A01, € 95,-
- Stand to be screwed onto the platform, height of stand approx. 600 mm, KERN SFB-A01, € 80,-
- **4** Stand to elevate display device, height of stand approx. 800 mm, KERN BFS-A07, € 120,-
- Further details, plenty of further accessories and suitable printers see Accessories

STANDARD

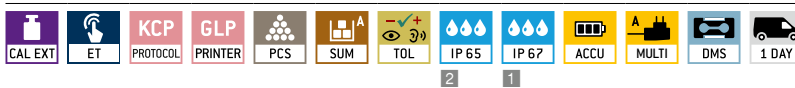

OPTION



FACTORY

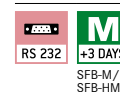

Model	Weighing capacity [Max] kg	Readability [d] g	Verification value [e] g	Minimal load [Min] g	Net weight approx. kg	Weighing plate W×D	Price excl. of VAT ex works €	Option				
								Verification		DAkkS Calibr. Certificate		
KERN							€	€	DAkkS KERN	€	€	
SFB 50K-3XL	50	5	-	-	14	500×400	830,-	-	-	963-128	94,-	-
SFB 100K-2XL	100	10	-	-	24	650×500	1130,-	-	-	963-129	116,-	-
with elevated display												
SFB 10K1HIP	10	1	-	-	8	300×240	670,-	-	-	963-128	94,-	-
SFB 20K2HIP	20	2	2	-	8	300×240	670,-	-	-	963-128	94,-	-
SFB 50K5HIP	50	5	5	-	8	300×240	670,-	-	-	963-128	94,-	-
SFB 50K5LHIP	50	5	5	-	10	400×300	710,-	-	-	963-128	94,-	-
SFB 100K10HIP	100	10	-	-	10	400×300	730,-	-	-	963-129	116,-	-
Note: For applications that require verification, please order verification at the same time, initial verification at a later date is not possible. Verification at the factory, we need to know the full address of the location of use.												
SFB 60K-2XLM	60	20	20	400	14	500×400	930,-	965-229	93,-	963-129	116,-	-
SFB 100K-2XLM	150	50	50	1000	24	650×500	1150,-	965-229	93,-	963-129	116,-	-
with elevated display												
SFB 15K5HIPM	15	5	5	100	8	300×240	680,-	965-228	70,-	963-128	94,-	-
SFB 30K10HIPM	30	10	10	200	8	300×240	690,-	965-228	70,-	963-128	94,-	-
SFB 60K20LHIPM	60	20	20	400	10	400×300	740,-	965-229	93,-	963-129	116,-	-
SFB 100K-2HM	150	50	50	1000	10	400×300	760,-	965-229	93,-	963-129	116,-	-

Price reduction



Stainless steel platform scale with stainless steel IP68 display and EC type approval [M]

Features

- Ideal for the robust industrial applications
- **1** Platform: made entirely of stainless steel, silicone-coated stainless steel load cell, protection against dust and water splashes IP68
- Display device: Stainless steel, protection against dust and water splashes IP68, integrated power supply
- Suitable for the ever-increasing hygienic requirements in the food industry
- Wall mount for display device, standard
- Superior display size: digit height 55 mm, bright backlight for easy reading of weighing results, even in poor lighting conditions
- Easy-to use KERN menu structure with printout of weighing results which can be intuitively adapted
- Thanks to interfaces such as RS-232, RS-485 and Bluetooth (optional) the scale can easily be connected to existing networks and facilitates the data exchange between the scale and printer

Technical data

- Large backlit LCD display, digit height 55 mm
- Weighing plate dimensions, stainless steel W×D×H
 - A** 300×240×86 mm, see larger picture
 - B** 400×300×89 mm
 - C** 500×400×123 mm
 - D** 650×500×133,5 mm
- Dimensions of display device W×D×H 232×170×80 mm
- Cable length of display device approx. 2,5 m

Accessories

- Stand to elevate display device, for models with weighing plate size
 - A - D** Height of stand approx. 200 mm, KERN IXS-A02, **€ 70,-**
 - B - D** Height of stand approx. 400 mm, KERN IXS-A03, **€ 75,-**
 - C - D** Height of stand approx. 600 mm, KERN IXS-A04, **€ 85,-**
- Internal rechargeable battery pack, operating time up to 80 h without backlight, charging time approx. 12 h, must be ordered at purchase, KERN GAB-A04, **€ 40,-**
- Data interface RS-232, interface cable included, approx. 1,5 m, must be ordered at purchase, KERN KXS-A04, **€ 100,-**
- Data interface RS-485, must be ordered at purchase, KERN KXS-A01, **€ 145,-**
- Foot switch, must be ordered at purchase, KERN KXS-A03, **€ 130,-**
- Bluetooth data interface for wireless data transfer to PC or tablets, must be ordered at purchase, not in combination with verification, KERN KXS-A02, **€ 170,-**
- Further details, plenty of further accessories and suitable printers see *accessories*

STANDARD



OPTION



FACTORY

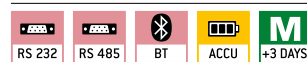

Model	Weighing capacity [Max] kg	Readability [d] g	Verification value [e] g	Minimal load [Min] g	Linearity g	Weighing plate	Price excl. of VAT ex works €	Option			
								Verification		DAKKS Calibr. Certificate	
KERN								M KERN	€	DAKKS KERN	€
SXS 6K-3M	3 6	1 2	1 2	20 40	± 1 2	A	700,-	965-228	70,-	963-128	94,-
SXS 10K-3M	6 15	2 5	2 5	40 100	± 2 5	A	700,-	965-228	70,-	963-128	94,-
SXS 10K-3LM	6 15	2 5	2 5	40 100	± 2 5	B	905,-	965-228	70,-	963-128	94,-
SXS 30K-2M	15 30	5 10	5 10	100 200	± 5 10	B	905,-	965-228	70,-	963-128	94,-
SXS 30K-2LM	15 30	5 10	5 10	100 200	± 5 10	C	1120,-	965-228	70,-	963-128	94,-
SXS 60K-2M	30 60	10 20	10 20	200 400	± 10 20	B	915,-	965-229	93,-	963-129	116,-
SXS 60K-2LM	30 60	10 20	10 20	200 400	± 10 20	C	1120,-	965-229	93,-	963-129	116,-
SXS 100K-2M	60 150	20 50	20 50	400 1000	± 20 50	C	1120,-	965-229	93,-	963-129	116,-
SXS 100K-2LM	60 150	20 50	20 50	400 1000	± 20 50	D	1370,-	965-229	93,-	963-129	116,-
SXS 300K-2M	150 300	50 100	50 100	1000 2000	± 50 100	D	1370,-	965-229	93,-	963-129	116,-

Dual-range balance switches automatically to the next largest weighing capacity [Max] and readability [d]

Note: For applications that require verification, please order verification at the same time, initial verification at a later date is not possible.

Verification at the factory, we need to know the full address of the location of use.

* Either RS-232 or RS-485 can be installed and used

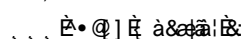

Price computing scales

Price computing scales are used wherever the price of goods is calculated dependent on the weight of the goods. These scales are subject to obligatory verification (► **Verification**) in accordance with European Directive 2014/31/EU. Usually, these are verification class **M100** scales

KERN mobile retail scales are compact in size and therefore save space on the sales counter. Thanks to the simple menu structure they are easy to use – saving time and money. Fitted with mains or rechargeable batteries as standard, price computing scales can be used in retail shops as well as on mobile sales stalls.

All price computing scales from KERN have three displays showing you all important information at a glance:

- Weight display in kg (verifiable)
- Unit price in €/kg or €/100 g
- Total price in €

NOTE: The KERN RFE range also displays the TARE or PRE-TARE value, which enables this value to be stored in a legally binding way in accordance with the Weights and Measures Act.

Even the KERN entry level retail scales have direct access keys for memories (► **PLU**). The sales item with the relevant price can be stored against these PLU. In this way, frequently used sales items can be called up at lightning speed. This accelerates customer service and reduces waiting times.

► See the glossary on page 223–225

Quick-Finder Price computing scales											
Readability [d] g	Weighing capacity [Max] kg	Model KERN	Price excl. of VAT ex works €	Page	DAYS	M	CAL EXT	RS 232	MEMORY	ACCU	For an explanation on the pictos, see front flap
1 2	3 6	RIB 6K-3HM	225,-	74	1	○	●		●	○	
1 2	3 6	RPB 6K1DM	205,-	75	1	○	●	●	●	○	
1 2	3 6	RPB 6K1DHM	220,-	75	1	○	●	●	●	○	
2 5	6 15	RIB 10K-3M	200,-	74	1	○	●		●	○	
2 5	6 15	RIB 10K-3HM	225,-	74	1	○	●		●	○	
2 5	6 15	RPB 15K2DM	205,-	75	1	○	●	●	●	○	
2 5	6 15	RPB 15K2DHM	220,-	75	1	○	●	●	●	○	
5 10	15 30	RIB 30K-2M	200,-	74	1	○	●		●	○	
5 10	15 30	RIB 30K-2HM	225,-	74	1	○	●		●	○	
5 10	15 30	RPB 30K5DM	205,-	75	1	○	●	●	●	○	
5 10	15 30	RPB 30K5DHM	220,-	75	1	○	●	●	●	○	

● = standard ○ = option

from €
200,-

KERN RIB

Page 74

- Intuitive operation
- Little space requirements
- Mains operation and rechargeable battery pack possible
- Second display which can be fitted on the back of the balance





Robust retail scale with large item memory, user-friendly handling and EC type approval [M]

Features

- **1** KERN RIB-HM: Elevated display backlit, height of stand approx. 530 mm, must be ordered at purchase
- **2** KERN RIB-M: Second display on the rear of the balance
- Three displays for weight display (verifiable), unit price, total price
- Soil-resistant construction through water channels at the frame of the housing and sealing rings over the upper housing inlets
- 10 Direct price keys for frequently recurring article prices
- Memory (PLU) for 20 article prices
- Energy management: Backlight turns off after 5 s, can be switched off
- Protective working cover included with delivery

Technical data

- Large backlit LCD displays, digit height 18 mm
- Dimensions weighing surface, stainless steel, WxD 294x225 mm
- Overall dimensions WxDxH
KERN RIB-M: 325x400x115 mm
KERN RIB-HM: 325x340x405 mm
- Net weight
KERN RIB-M: approx. 3,2 kg
KERN RIB-HM: approx. 3,8 kg
- Permissible ambient temperature -10 °C/40 °C

Accessories

- Protective working cover, scope of delivery: 5 items, KERN RIB-A01S05, **€ 40,-**
- Internal rechargeable battery pack, operating time up to 80 h without backlight, charging time approx. 14 h, KERN GAB-A04, **€ 40,-**
- **3** Tare pan made of stainless steel, ideal for weighing loose small parts, fruit, vegetables etc., WxDxH 370x240x20 mm, KERN RFS-A02, **€ 55,-**

Application examples

- retail shops
- weekly markets
- farm shops
- pick your own fruit and vegetable sales

Note: Official verification duty for commercial trade

STANDARD						OPTION		FACTORY
CAL EXT	MEMORY	UNIT	DMS	230 V	1 DAY	ACCU	+3 DAYS	+3 DAYS

Model	Weighing capacity [Max] kg	Readability [d] g	Verification value [e] g	Minimal load [Min] g	Price excl. of VAT ex works €	Option			
						Verification		DAKKS Calibr. Certificate	
KERN					€	€	DAKKS KERN	€	€
Dual-range balance switches automatically to the next largest weighing capacity [Max] and readability [d]									
RIB 6K-3M	3 6	1 2	1 2	20 40	200,-	965-228	70,-	963-128	94,-
RIB 10K-3M	6 15	2 5	2 5	40 100	200,-	965-228	70,-	963-128	94,-
RIB 30K-2M	15 30	5 10	5 10	100 200	200,-	965-228	70,-	963-128	94,-
with elevated display									
RIB 6K-3HM	3 6	1 2	1 2	20 40	225,-	965-228	70,-	963-128	94,-
RIB 10K-3HM	6 15	2 5	2 5	40 100	225,-	965-228	70,-	963-128	94,-
RIB 30K-2HM	15 30	5 10	5 10	100 200	225,-	965-228	70,-	963-128	94,-

Note: For applications that require verification, please order verification at the same time, initial verification at a later date is not possible.
Verification at the factory, we need to know the full address of the location of use.

Price reduction



Retail scale with memories for item prices - now in new compact housing

Features

- **NEW:** modern, ergonomic design and a housing which is even more compact, supporting efficient operation and saving space
- **1** KERN RPB-HM: Elevated display backlit, revolving on column, height of stand approx. 480 mm, must be ordered at purchase
- **2** KERN RPB-M: Second display on the rear of the balance
- Three displays for weight display (verifiable), unit price, total price
- Memory (PLU) for 10 article prices
- Unit price can be switched from €/kg to €/100 g
- Auto-clear-key: Unit price entry is automatically set to zero when scale is unloaded
- **3** High mobility: thanks to rechargeable battery operation (optional), compact, lightweight construction, it is suitable for the use in several locations
- Protective working cover included with delivery

Technical data

- Large backlit LCD displays, digit height 15 mm
- Dimensions weighing surface, stainless steel, WxD 204x263 mm
- Overall dimensions WxDxH
RPB-M: 263x313x108 mm
RPB-HM: 263x313x480 mm
- Net weight
KERN RPB-M: approx. 2,8 kg
KERN RPB-HM: approx. 3,2 kg
- Permissible ambient temperature -10 °C/40 °C

Accessories

- Protective working cover, scope of delivery: 5 items, KERN RFC-A02S05, € 40,-
- Internal rechargeable battery pack, operating time up to 50 h without backlight, charging time approx. 12 h, KERN WTB-A01N, € 35,-
- **4** Tare pan made of stainless steel, ideal for weighing loose small parts, fruit, vegetables etc., WxDxH 370x240x20 mm, KERN RFS-A02, € 55,-
- Further details, plenty of further accessories and suitable printers see *Accessories*

Application examples

- retail shops
- weekly markets
- farm shops
- pick your own fruit and vegetable sales

Note: Official verification duty for commercial trade

STANDARD



OPTION

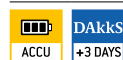

FACTORY



Model	Weighing capacity [Max] kg	Readability [d] g	Verification value [e] g	Minimal load [Min] g	Price excl. of VAT ex works €	Option				
						Verification		DAkkS Calibr. Certificate		
KERN						KERN	€	DAKKS KERN	€	
Dual-range balance switches automatically to the next largest weighing capacity [Max] and readability [d]										
RPB 6K1DM	3 6	1 2	1 2	20	205,-	965-228	70,-	963-128	94,-	
RPB 15K2DM	6 15	2 5	2 5	40	205,-	965-228	70,-	963-128	94,-	
RPB 30K5DM	15 30	5 10	5 10	100	205,-	965-228	70,-	963-128	94,-	
with elevated display										
RPB 6K1DHM	3 6	1 2	1 2	20	220,-	965-228	70,-	963-128	94,-	
RPB 15K2DHM	6 15	2 5	2 5	40	220,-	965-228	70,-	963-128	94,-	
RPB 30K5DHM	15 30	5 10	5 10	100	220,-	965-228	70,-	963-128	94,-	

Note: For applications that require verification, please order verification at the same time, initial verification at a later date is not possible.
Verification at the factory, we need to know the full address of the location of use.

Discover & subscribe to our
KERN YouTube channel

www.youtube.com/user/KernSohn



Helpful product videos
Practical support in everyday weighing

Weighing functions clearly explained
Step-by-step user guidance in many languages

Constantly updated with new, interesting products and features

Self-explanatory and intuitive without complicated operating instructions

SUBSCRIBE



Counting scales/Counting systems

Interesting facts about counting

Smallest part weight for piece counting

This is the smallest piece weight the scale will accept for piece counting and will display it piece by piece. In practice, depending on the required accuracy, we recommend to choose a counting scale with a minimum piece weight smaller than the weight of the item to be counted. To make it easier for you to select the right model, we specify the smallest part weight when counting under laboratory conditions and normal conditions, see the website.

► Counting resolution

Describes the maximum quantity which can be counted with a counting accuracy of 1 %, with a minimum variation of item weights and a sufficiently large ► **reference quantity** (20 pieces with counting resolution $\leq 60,000$ points, 50 pieces from 60,000–150,000 points, 100 pieces $\geq 150,000$ points). This therefore is an indication of the quality of the counting scale.

Recommended ► reference quantity

Weight tolerances of pieces to be counted are the most significant sources of error when counting. Therefore, at the start of every counting procedure, establish an average weight, the so-called ► **reference weight**, by placing several pieces on the balance, the so-called reference quantity. Usually this would be:

5 pieces	>> often sufficient
10 pieces	>> common practise
20–100 pieces	>> for large deviations among piece weights

The “automatic ► **reference optimisation**” function increases the reference quantity gradually, whereby the average piece weight is optimised step by step. This contributes considerably to the accuracy of the subsequent counting processes.

Which counting scale for which application?

Simple counting scale

with self-explanatory user guidance on the keyboard. The graphic control panel enables you to start working immediately, without having to consult the user manual. Easy handling, value for money.

Professional counting scale

with 3 separate displays for reference weight (average weight of the pieces), total weight of all pieces and total quantity of all pieces. Very useful integrated memories, e.g. for container weight, item number, reference weight as well as audible and visual counting aids and an alphanumeric key pad for easy data entry.

Special tip for counting large quantities:

Counting systems

The weighing capacities of bench counting scales are often not sufficient to count large quantities, units, palletized items, etc. Here high-performance counting systems come into operation, as these combine a high-precision reference scale with a high-capacity bulk scale.

► See the glossary on page 223–225

KERN CIB

Page 80

- Robust counting scale
- Large article memory
- Special checkweighing display
- Three displays for weight indication, reference weight, total quantity







only €
240,-



Quick-Finder Counting scales/Counting systems

Readability [d] g	Weighing capacity [Max] kg	Counting resolution Points	Model KERN	Price excl. of VAT ex works €	Page								For an explanation on the pictos, see front flap						
													1		●	●	●	●	●
0,001	0,3	60.000	CFS 300-3	365,-	83	1			●	●	●	●	○						
0,001	0,36	360.000	CKE 360-3	290,-	84	1			●	●	●	●	○						
0,001	6	1.200.000	CCS 6K-6	630,-	88	2			●	●	●	●	○						
0,001	15	300.000	CCS 10K-6	660,-	88	2			●	●	●	●	○						
0,01	2	200.000	CKE 2000-2	330,-	84	1			●	●	●	●	○						
0,01	3	60.000	CFS 3K-5	310,-	83	1			●	●	●	●	○						
0,01	3,6	360.000	CKE 3600-2	350,-	84	1			●	●	●	●	○						
0,01	3 6	6.000.000	CCA 6K-5M	890,-	87	2	○		●	●	●	●	○						
0,01	6 15	15.000.000	CCA 10K-5M	890,-	87	2	○		●	●	●	●	○						
0,01	30	600.000	CCS 30K0.01.	540,-	88	2			●	●	●	●	○						
0,01	15 30	30.000.000	CCA 30K-5M	960,-	87	2	○		●	●	●	●	○						
0,01	30 60	60.000.000	CCA 60K-5M	960,-	87	2	○		●	●	●	●	○						
0,01	60	1.200.000	CCS 60K0.01.	540,-	88	2			●	●	●	●	○						
0,01	60	1.200.000	CCS 60K0.01L.	620,-	88	2			●	●	●	●	○						
0,01	60 150	150.000.000	CCA 100K-5M	1070,-	87	2	○		●	●	●	●	○						
0,01	150	3.000.000	CCS 150K0.1L	820,-	88	2			●	●	●	●	○						
0,01	150	3.000.000	CCS 150K0.01	650,-	88	2			●	●	●	●	○						
0,01	150 300	300.000.000	CCA 300K-5M	1250,-	87	2*	○		●	●	●	●	○						
0,01	300	6.000.000	CCS 300K0.01	860,-	88	2*			●	●	●	●	○						
0,01	600	12.000.000	CCS 600K-2U	1490,-	88	4*			●	●	●	●	○						
0,01	600	12.000.000	CCS 600K-2L	1950,-	88	4*			●	●	●	●	○						
0,02	4	200.000	CDS 4K0.02	560,-	86	1			●	●	●	●	○						
0,02	6	300.000	CKE 6K0.02	490,-	84	1			●	●	●	●	○						
0,05	8	160.000	CKE 8K0.05	470,-	84	1			●	●	●	●	○						
0,05	15	300.000	CDS 15K0.05	490,-	86	1			●	●	●	●	○						
0,05	16	320.000	CKE 16K0.05	570,-	84	1			●	●	●	●	○						
0,1	6	60.000	CPB 6K0.1N	225,-	82	1			●	●	●	●	○						
0,1	6	60.000	CFS 6K0.1	270,-	83	1			●	●	●	●	○						
0,1	16	160.000	CKE 16K0.1	460,-	84	1			●	●	●	●	○						
0,1	16	160.000	CDS 16K0.1	470,-	86	1			●	●	●	●	○						
0,1	30	300.000	CCS 30K0.1.	490,-	88	2			●	●	●	●	○						
0,1	30	300.000	CDS 30K0.1	560,-	86	1			●	●	●	●	○						
0,1	30	300.000	CDS 30K0.1L	720,-	86	1			●	●	●	●	○						
0,1	36	360.000	CKE 36K0.1	520,-	84	1			●	●	●	●	○						
0,1	60	600.000	CCS 60K0.1.	495,-	88	2			●	●	●	●	○						
0,1	60	600.000	CCS 60K0.1L.	570,-	88	2			●	●	●	●	○						
0,1	150	1.500.000	CCS 150K0.1.	540,-	88	2			●	●	●	●	○						
0,1	150	3.000.000	CCS 150K0.01L	860,-	88	2			●	●	●	●	○						
0,1	300	3.000.000	CCS 300K0.1	790,-	88	2			●	●	●	●	○						
0,1	300 600	6.000.000	CCS 600K-1S	1400,-	88	4*			●	●	●	●	○						
0,1	300 600	6.000.000	CCS 600K-1	1650,-	88	4*			●	●	●	●	○						
0,1	600 1500	15.000.000	CCS 1T-4S	1400,-	88	4*			●	●	●	●	○						
0,1	600 1500	15.000.000	CCS 1T-4	1650,-	88	4*			●	●	●	●	○						
0,1	1500	15.000.000	CCS 1T-1U	1430,-	88	4*			●	●	●	●	○						
0,1	1500	15.000.000	CCS 1T-1L	1880,-	88	4*			●	●	●	●	○						
0,1	1500 3000	30.000.000	CCS 3T-3	1650,-	88	4*			●	●	●	●	○						
0,1	1500 3000	30.000.000	CCS 3T-3L	1850,-	88	4*			●	●	●	●	○						
0,1 0,2	3 6	60.000	IFS 6K-4S	390,-	85	1			●	●	●	●	○						
0,1 0,2	6 15	75.000	IFS 10K-4	405,-	85	1			●	●	●	●	○						
0,2	3	30.000	CIB 3K-4	240,-	80	1			●	●	●	●	○						
0,2	3	30.000	CXB 3K0.2	230,-	81	1			●	●	●	●	○						
0,2	15	60.000	CPB 15K0.2N	225,-	82	1			●	●	●	●	○						
0,2	15	75.000	CFS 15K0.2	270,-	83	1			●	●	●	●	○						
0,2	36	180.000	CDS 36K0.2L	710,-	86	1			●	●	●	●	○						
0,2	60	300.000	CDS 60K0.2	720,-	86	1			●	●	●	●	○						
0,2	65	325.000	CKE 65K0.2	520,-	84	1			●	●	●	●	○						
0,2 0,5	12 30	60.000	IFS 30K0.2DL	450,-	85	1			●	●	●	●	○						
0,5	6	30.000	CIB 6K-4	240,-	80	1			●	●	●	●	○						
0,5	6	30.000	CXB 6K0.5	230,-	81	1			●	●	●	●	○						
0,5	30	60.000	CPB 30K0.5N	225,-	82	1			●	●	●	●	○						
0,5	30	60.000	CFS 30K0.5	270,-	83	1			●	●	●	●	○						
0,5	65	130.000	CKE 65K0.5	480,-	84	1			●	●	●	●	○						
0,5 1	30 60	60.000	IFS 60K0.5D	450,-	85	1			●	●	●	●	○						
0,5 1	30 60	60.000	IFS 60K0.5DL	550,-	85	1			●	●	●	●	○						
1	3	30.000	CXB 3K1NM	245,-	81	1	○		●	●	●	●	○						
1	15	30.000	CXB 15K1	230,-	81	1			●	●	●	●	○						
1	50	50.000	CFS 50K-3	295,-	83	1			●	●	●	●	○						
1 2	3 6	60.000	IFS 6K-3SM	350,-	85	1	○		●	●	●	●	○						
1 2	3 6	60.000	IFS 6K-3M	410,-	85	1	○		●	●	●	●	○						
1 2	3 6	60.000	CPB 6K1DM	225,-	82	1	○		●	●	●	●	○						
1 2	75 150	60.000	IFS 100K-3	630,-	85	1			●	●	●	●	○						

Quick-Finder Counting scales/Counting systems

Readability [d] g	Weighing capacity [Max] kg	Counting resolution Points	Model KERN	Price excl. of VAT ex works €	Page								For an explanation on the pictos, see front flap						
													1	2	3	4	5	6	7
1 2	75 150	60.000	IFS 100K-3L	790,-	85	1		●	●	●			○						
2	6	30.000	CXB 6K2NM	245,-	81	1	○	●					●						
2	30	30.000	CIB 30K-3	240,-	80	1		●											
2	30	30.000	CXB 30K2	230,-	81	1		●									●		
2 5	6 15	60.000	CPB 15K2DM	225,-	82	1	○	●			●						○		
2 5	6 15	75.000	IFS 10K-3M	410,-	85	1	○	●		●	●						○		
2 5	6 15	75.000	IFS 10K-3LM	460,-	85	1	○	●		●	●						○		
2 5	6 15	75.000	IFS 300K-3	790,-	85	1		●		●	●						○		
5	15	30.000	CIB 10K-3	240,-	80	1		●											
5	15	30.000	CXB 15K5NM	245,-	81	1	○	●									●		
10	30	30.000	CXB 30K10NM	245,-	81	1	○	●									●		
50	15 30	60.000	CPB 30K5DM	225,-	82	1	○	●			●						○		
50	15 30	60.000	IFS 30K-3M	460,-	85	1	○	●		●	●						○		
50	150	1.500.000	IFS 300K-2M	720,-	85	1	○	●		●	●		●				○		
10 20	30 60	60.000	IFS 60K-2M	460,-	85	1	○	●		●	●						○		
10 20	30 60	60.000	IFS 60K-2LM	550,-	85	1	○	●		●	●		●				○		
20 50	60 150	60.000	IFS 100K-2M	550,-	85	1	○	●		●	●		●				○		
20 50	60 150	60.000	IFS 100K-2LM	720,-	85	1	○	●		●	●		●				○		

News 2021

* Shipment via freight forwarder. Please ask for dimensions, gross weight, shipping costs

● = standard ○ = option

NEW



Robust counting scale with large article memory, convenient operating philosophy and checkweighing display, counting resolution up to 30,000 points

Features

- Innovative counting with tolerance range (Checkweighing):
The counting process can be supported visually and/or audibly and this therefore makes portion division, dispensing and grading easier
 - visual signal: the colour of the display changes depending on the counting result (not enough/ok/too much)
 - audible signal: the frequency of the audible signal changes depending on the counting result (not enough/ok/too much) Ideal for workshops for people with disabilities, particularly loud or quiet environments, where operators change frequently, etc.
- Three displays for weight display, reference weight, total pieces
- Precise counting: The automatic reference weight optimisation of reference weight gradually improves the average piece weight value
- Programmable using numerical key pad:
 - required reference quantity
 - known reference weight

- Counting results memory: adds up all individual piece counts, result is shown in total weight and total pieces
- PRE-TARE function for manual subtraction of a known container weight, useful for checking fill-levels
- 20 direct price keys for frequently recurring reference weights and PRE-Tare values
- Memory (PLU) for 50 reference weights and PRE-Tare values
- High mobility: thanks to battery operation, compact, lightweight construction, it is suitable for the use in several locations
- Two balances in one: Changes from counting mode to weighing mode at the touch of a key
- Energy management: Backlight turns off after 5 sec, can be switched off
- Protective working cover included with delivery

Technical data

- Large backlit LCD displays, digit height 18 mm
- Dimensions weighing surface, Stainless Steel, W×D 350×215 mm Overall dimensions W×D×H, 350×330×120 mm
- Net weight approx. 4,0 kg
- Permissible ambient temperature, Permissible ambient temperature -10 °C/40 °C

Accessories

- Protective working cover, scope of delivery: 5 items, KERN RIB-A01S05, **€ 40,-**
- Internal rechargeable battery pack, operating time up to 160 h without backlight, charging time approx. 14 h, KERN GAB-A04, **€ 40,-**

STANDARD

OPTION

Model	Weighing capacity [Max] kg	Readability [d] g	Smallest part weight [Normal] g/piece	Counting resolution Points	Price excl. of VAT ex works €	Option	
						DAKKS KERN	DAKKS Calibr. Certificate €
KERN CIB 3K-4	3	0,2	1	30.000	240,-	963-127	78,-
CIB 6K-4	6	0,5	2	30.000	240,-	963-128	94,-
CIB 10K-3	15	1	5	30.000	240,-	963-128	94,-
CIB 30K-3	30	2	10	30.000	240,-	963-128	94,-



Note: Official verification duty for commercial trade

Entry level model into professional counting, also with EC type approval [M], counting resolution of 30,000 points

Features

- Precise counting: The automatic reference weight optimisation of reference weight gradually improves the average piece weight value
- Programmable using numerical key pad:
 - required reference quantity
 - known reference weight
- Three displays for weight display, reference weight, total pieces
- Audible Fill-to-target: target quantity or target weight can be programmed, e. g. for checkweighing. When the target value is reached, a signal will sound
- 10 memories for reference weights
- Counting results memory: adds up all individual piece counts, result is shown in total weight and total pieces
- Energy management: Backlight turns off after 5 sec

- PRE-TARE function for manual subtraction of a known container weight, useful for checking fill-levels
- Two balances in one: Changes from counting mode to weighing mode at the touch of a key
- Protective working cover included with delivery
- Internal rechargeable battery pack included with the delivery

Technical data

- Large backlit LCD displays, digit height 18 mm
- Dimensions weighing surface, Stainless Steel, WxD 300x225 mm
- Dimensions housing WxDxH, 300x330x110 mm
- Internal rechargeable battery pack, operating time up to 200 h without backlight, charging time approx. 8 h
- Net weight approx. 4,0 kg
- Permissible ambient temperature -10 °C/40 °C

Accessories

- Protective working cover, scope of delivery: 5 items, KERN CXB-A01S05, € 40,-
- Internal rechargeable battery pack, operating time up to 200 h without backlight, charging time approx. 8 h, KERN GAB-A04, € 40,-

STANDARD

CAL EXT PCS SUM ACCU 230 V DMS 1 DAY

OPTION FACTORY

DAKKS +3 DAYS M +3 DAYS CXB-NM

Model	Weighing capacity [Max] kg	Readability [d] g	Verification value [e] g	Minimal load [Min] g	Smallest part weight [Normal] g/piece	Counting resolution Points	Net weight approx. kg	Price excl. of VAT ex works €	Option			
									Verification		DAKKS Calibr. Certificate	
KERN								M KERN	€	DAKKS KERN	€	
CXB 3K0.2	3	0,2	-	-	1	30.000	4,0	230,-	-	-	963-127	78,-
CXB 6K0.5	6	0,5	-	-	2	30.000	4,0	230,-	-	-	963-128	94,-
CXB 15K1	15	1	-	-	5	30.000	4,0	230,-	-	-	963-128	94,-
CXB 30K2	30	2	-	-	10	30.000	4,2	230,-	-	-	963-128	94,-
Note: For applications that require verification, please order verification at the same time, initial verification at a later date is not possible. Verification at the factory, we need to know the full address of the location of use.												
CXB 3K1NM	3	1	1	20	1	30.000	4,0	245,-	965-227	55,-	963-127	78,-
CXB 6K2NM	6	2	2	40	2	30.000	4,2	245,-	965-228	70,-	963-128	94,-
CXB 15K5NM	15	5	5	100	5	30.000	4,0	245,-	965-228	70,-	963-128	94,-
CXB 30K10NM	30	10	10	200	10	30.000	4,2	245,-	965-228	70,-	963-128	94,-



Note: Official verification duty for commercial trade

Professional model, also with EC type approval [M], counting resolution up to 60,000 points

Features

- Precise counting: The automatic reference weight optimisation of reference weight gradually improves the average piece weight value
- Programmable using numerical key pad:
 - required reference quantity
 - known reference weight
- Three displays for weight display, reference weight, total pieces
- Counting results memory: adds up all individual piece counts, result is shown in total weight and total pieces
- Fill-to-target function: Target count or target weight can be programmed. When the target weight is reached there is an audible and visual signal
- PRE-TARE function for manual subtraction of a known container weight, useful for checking fill-levels

- High mobility: thanks to rechargeable battery operation (optional), compact, lightweight construction, it is suitable for the use in several locations (production, warehouse, dispatch department etc.)
- Two balances in one: Changes from counting mode to weighing mode at the touch of a key
- Protective working cover included with delivery

Technical data

- Large backlit LCD displays, digit height 20 mm
- Dimensions weighing surface, Stainless Steel, W×D 295×225 mm Overall dimensions W×D×H 315×350×105 mm
- Net weight approx. 3,2 kg
- Permissible ambient temperature 0 °C/40 °C

Accessories

- Protective working cover, scope of delivery: 5 items, KERN CFS-A02S05, € 40,-
- Internal rechargeable battery pack, operating time up to 90 h without backlight, charging time approx. 12 h, KERN GAB-A04, € 40,-
- Signal lamp for visual support of weighing with tolerance range, only in combination with, KERN CFS-A03, € 250,-
- Y-cable for parallel connection of two terminal devices to the RS-232 interface on the scale, e.g. signal lamp and printer, KERN CFS-A04, € 35,-
- Further details, plenty of further accessories and suitable printers see *Accessories*

STANDARD										OPTION		FACTORY	
CAL EXT	RS 232	KCP	PCS	SUM	TOL	MULTI	DMS	1 DAY	ACCU	DAkkS	M	+3 DAYS	
										CPB-DM			

Model	Weighing capacity [Max] kg	Readability [d] g	Verification value [e] g	Minimal load [Min] g	Smallest part weight [Normal] g/piece	Counting resolution Points	Price excl. of VAT ex works €	Option				
								Verification		DAkkS Calibr. Certificate		
KERN									€	DAkkS KERN	€	
CPB 6K0.1N	6	0,1	-	-	1	60.000	225,-	-	-	963-128	94,-	
CPB 15K0.2N	15	0,2	-	-	2,5	60.000	225,-	-	-	963-128	94,-	
CPB 30K0.5N	30	0,5	-	-	5	60.000	225,-	-	-	963-128	94,-	
Dual-range balance switches automatically to the next largest weighing capacity [Max] and readability [d]												
Note: For applications that require verification, please order verification at the same time, initial verification at a later date is not possible.												
Verification at the factory, we need to know the full address of the location of use.												
CPB 6K1DM	3 6	1 2	1 2	20	1	60.000	225,-	965-228	70,-	963-128	94,-	
CPB 15K2DM	6 15	2 5	2 5	40	2,5	60.000	225,-	965-228	70,-	963-128	94,-	
CPB 30K5DM	15 30	5 10	5 10	100	5	60.000	225,-	965-228	70,-	963-128	94,-	

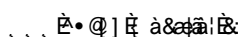



Professional, high-resolution counting scale with 100 item memories and second balance interface, counting resolution up to 75,000 points

Features

- Memory (PLU) for 100 items with additional text, reference weight and tare weight, e.g. of a container
- Precise counting: The automatic reference weight optimisation of reference weight gradually improves the average piece weight value
- Programmable using numerical key pad:
 - required reference quantity
 - known reference weight
- Three displays for weight display, reference weight, total pieces
- Weighing with tolerance range (checkweighing): a visual and audible signal helps with portioning, dispensing or grading
- Fill-to-target function
Programmable target quantity or target weight. A signal will be displayed when the target value is reached
- PRE-TARE function for manual subtraction of a known container weight, useful for checking fill-levels

- Second balance interface to construct a high-resolution counting system, standard, e.g. with weighing bridges of KERN KFP V20
- Draught shield standard for models with weighing plate size **A**, weighing space W×D×H 158×143×64 mm
- Protective working cover included with delivery, for models with weighing plate size **A**, **B**

Technical data

- Large backlit LCD displays, digit height 20 mm
- Dimensions weighing surface
 - A** Ø 80 mm
 - B** W×D 295×225 mm
 - C** W×D 370×240 mm
- Overall dimensions W×D×H
 - A** 315×350×180 mm (incl. draught shield)
 - B** 315×350×180 mm
 - C** 375×350×130 mm
- Permissible ambient temperature 0 °C/40 °C

Accessories

- Protective working cover, scope of delivery: 5 items, for models with weighing plate size **A**, **B**, KERN CFS-A02S05, **€ 40,-**
- Internal rechargeable battery pack, operating time up to 70 h without backlight, charging time approx. 14 h, KERN GAB-A04, **€ 40,-**
- Signal lamp for visual support of weighing with tolerance range, only in combination with, KERN CFS-A03, **€ 250,-**
- Y-cable for parallel connection of two terminal devices to the RS-232 interface on the scale, e.g. signal lamp and printer, KERN CFS-A04, **€ 35,-**
- Further details, plenty of further accessories and suitable printers see *Accessories*

STANDARD: CAL EXT, MEMORY, RS 232, KCP PROTOCOL, DUAL, SUM, TOL, MULTI, DMS, 1 DAY

OPTION: ACCU, DAKKS +3 DAYS

Model	Weighing capacity [Max] kg	Readability [d] g	Smallest part weight [Normal] g/piece	Counting resolution Points	Net weight approx. kg	Weighing plate	Price excl. of VAT ex works €	Option	
								DAKKS KERN	Calibr. Certificate €
CFS 300-3	0,3	0,001	0,05	60.000	2,6	A	365,-	963-127	78,-
CFS 3K-5	3	0,01	0,5	60.000	3,4	B	310,-	963-127	78,-
CFS 6K0.1	6	0,1	1	60.000	3,2	B	270,-	963-128	94,-
CFS 15K0.2	15	0,2	2	75.000	3,4	B	270,-	963-128	94,-
CFS 30K0.5	30	0,5	5	60.000	3,4	B	270,-	963-128	94,-
CFS 50K-3	50	1	10	50.000	4,4	C	295,-	963-128	94,-

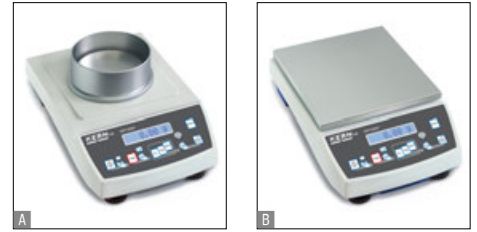

Easy to use, self-explanatory counting scale with laboratory accuracy, counting resolution up to 360,000 points

Features

- Self-explanatory graphic control panel, the workings steps can be understood immediately, even without operating instructions
 - no learning time = reduces costs
 - ideal for untrained users
 - visualised process avoids operating errors
- The 4 steps are carried out from left to right:
 - 1 Place the empty container onto the weighing plate and tare by pressing the TARE key
 - 2 Place the reference quantity for the goods to be counted into the container (5, 10 or 20 pieces)
 - 3 Confirm the selected reference quantity by pressing the key (5, 10 or 20)
 - 4 Pour in the goods to be counted. The number of pieces will immediately be shown in the display
- Precise counting: The automatic reference weight optimisation of reference weight gradually improves the average piece weight value

- Two balances in one: Changes from counting mode to weighing mode at the touch of a key
- Draught shield standard for models with weighing plate size \varnothing 81 mm, weighing space \varnothing 90x40 mm
- Protective working cover included with delivery

Technical data

- Large backlit display
 - A, B digit height 9 mm
 - C digit height 18 mm
- Dimensions weighing surface
 - A \varnothing 81 mm, plastic
 - B WxD 150x170 mm, stainless steel
 - C WxD 340x240 mm, stainless steel
- Overall dimensions WxDxH
 - A, B 167x250x85 mm
 - C 350x390x120 mm

- Optional battery operation, 6x1.5 V Size C not included, operating time up to 40 h, for models with weighing plate size C
- Permissible ambient temperature 10 °C/40 °C

Accessories

- Protective working cover, scope of delivery: 5 items, for models with weighing plate size
 - A KERN PCB-A02S05, € 40,-
 - B KERN PCB-A05S05, € 40,-
 - C KERN FKB-A02S05, € 40,-
- Rechargeable battery pack external, operating time up to 30 h without backlight, charging time approx. 10 h, KERN KS-A01, € 160,-
- Internal rechargeable battery pack, operating time up to 30 h without backlight, charging time approx. 10 h, for models with weighing plate size A, B, KERN KB-A01N, € 50,-
- USB data interface, for transferring weighing to the PC, printer etc., for models with weighing plate size C, KERN CKE-A02, € 65,-
- Further details, plenty of further accessories and suitable printers see *Accessories*

STANDARD

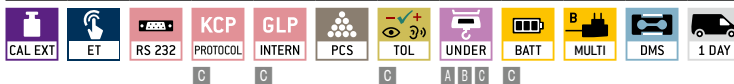

OPTION



FACTORY



Model	Weighing capacity [Max] kg	Readability [d] g	Smallest part weight [Normal] g/piece	Counting resolution Points	Net weight approx. kg	Weighing plate	Price excl. of VAT ex works €	Option	
								DAkKS	DAkKS Calibr. Certificate
KERN								DAkKS KERN	€
CKE 360-3	0,36	0,001	0,01	360.000	1	A	290,-	963-127	78,-
CKE 2000-2	2	0,01	0,1	200.000	1,8	B	330,-	963-127	78,-
CKE 3600-2	3,6	0,01	0,1	360.000	1,8	B	350,-	963-127	78,-
CKE 6K0.02	6	0,02	0,2	300.000	7	C	490,-	963-128	94,-
CKE 8K0.05	8	0,05	0,5	160.000	7	C	470,-	963-128	94,-
CKE 16K0.05	16	0,05	0,5	320.000	7	C	570,-	963-128	94,-
CKE 16K0.1	16	0,1	1	160.000	7	C	460,-	963-128	94,-
CKE 36K0.1	36	0,1	1	360.000	7	C	520,-	963-128	94,-
CKE 65K0.2	65	0,2	2	325.000	7	C	520,-	963-129	116,-



Industrial counting scale with convenient decimal keypad for easy data entry – now also with EC type approval [M], counting resolution up to 75000 points

Features

- Tough industry standard suitable for use in harsh industrial applications
- Ergonomic display device with large keypad and high-contrast LCD display for easy entry and reading of, e.g., tare weights, reference weights, limit values etc.
- Three displays for weight display, reference weight, total pieces
- 100 item memories for master data such as reference weight, reference quantity, container weight (PRE-TARE) etc.
- Printout of date and time for GLP and GMP compliant data logging

- Precise counting: The manual reference weight optimisation gradually improves the average value of the piece weight
- Totalising of pieces when counting
- Protective working cover included with delivery

Technical data

- Large backlit LCD displays, digit height 16,5 mm
- Dimensions weighing surface, Stainless Steel
 - A 230×230×110 mm
 - B 300×240×110 mm
 - C 400×300×120 mm
 - D 500×400×140 mm
 - E 650×500×140 mm

- Dimensions of display device W×D×H 260×150×65 mm
- Cable length of display device approx. 3 m
- Permissible ambient temperature -10 °C/40 °C

Accessories

- Protective working cover, scope of delivery: 5 items, KERN KFB-A02S05, **€ 40,-**
- ■ Stand to elevate display device
 - Height of stand approx. 330 mm, KERN IFB-A01, **€ 50,-**
 - Height of stand approx. 600 mm, for models with weighing plate size ■, ■, KERN IFB-A02, **€ 60,-**
- Internal rechargeable battery pack, operating time up to 40 h, without backlight, charging time approx. 12 h, must be ordered at purchase, KERN KFB-A01, **€ 35,-**
- ESD drain to protect against electrostatic discharge e.g. for electrostatically-charged weighing objects or people who work with the scale, KERN YGR-01, **€ 55,-**
- Further details, plenty of further accessories and suitable printers see *Accessories*

STANDARD: CAL EXT, MEMORY, RS 232, KCP, GLP, INTERN, PCS, SUM, PERCENT, TOL, MULTI, DMS, 1 DAY

OPTION: DAKkS +3 DAYS

FACTORY: ACCU +3 DAYS, M IFS-M

Model	Weighing capacity [Max] kg	Readability [d] g	Verification value [e] g	Smallest part weight [Normal] g/piece	Counting resolution Points	Net weight approx. kg	Weighing plate	Price excl. of VAT ex works €	Option			
									Verification		DAkkS Calibr. Certificate	
KERN								M KERN	€	DAkkS KERN	€	
Dual-range balance switches automatically to the next largest weighing capacity [Max] and readability [d]												
IFS 6K-4S	3 6	0,1 0,2	-	1	60.000	4,6	A	390,-	-	-	963-128	94,-
IFS 10K-4	6 15	0,1 0,2	-	2	75.000	6	B	405,-	-	-	963-128	94,-
IFS 30K0.2DL	12 30	0,2 0,5	-	5	60.000	11	C	450,-	-	-	963-128	94,-
IFS 60K0.5D	30 60	0,5 1	-	10	60.000	10	C	450,-	-	-	963-129	116,-
IFS 60K0.5DL	30 60	0,5 1	-	10	60.000	12	D	550,-	-	-	963-129	116,-
IFS 100K-3	75 150	1 2	-	25	60.000	12	D	630,-	-	-	963-129	116,-
IFS 100K-3L	75 150	1 2	-	25	60.000	20	E	790,-	-	-	963-129	116,-
IFS 300K-3	150 300	2 5	-	50	60.000	22	E	790,-	-	-	963-129	116,-

Note: For applications that require verification, please order verification at the same time, initial verification at a later date is not possible.

Verification at the factory, we need to know the full address of the location of use.

IFS 6K-3SM	3 6	1 2	1 2	1	60.000	6	A	350,-	965-228	70,-	963-128	94,-
IFS 6K-3M	3 6	1 2	1 2	1	60.000	6	B	410,-	965-228	70,-	963-128	94,-
IFS 10K-3M	6 15	2 5	2 5	2	75.000	6	B	410,-	965-228	70,-	963-128	94,-
IFS 10K-3LM	6 15	2 5	2 5	2	75.000	10	C	460,-	965-228	70,-	963-128	94,-
IFS 30K-3M	15 30	5 10	5 10	5	60.000	10	C	460,-	965-228	70,-	963-128	94,-
IFS 60K-2M	30 60	10 20	10 20	10	60.000	11	C	460,-	965-229	93,-	963-129	116,-
IFS 60K-2LM	30 60	10 20	10 20	10	60.000	13	D	550,-	965-229	93,-	963-129	116,-
IFS 100K-2M	60 150	20 50	20 50	25	60.000	12	D	550,-	965-229	93,-	963-129	116,-
IFS 100K-2LM	60 150	20 50	20 50	25	60.000	22	E	720,-	965-229	93,-	963-129	116,-
IFS 300K-2M	150 300	50 100	50 100	50	60.000	22	E	720,-	965-229	93,-	963-129	116,-



Easy to use industrial counting scale for heavy loads, counting resolution up to 300,000 points

Features

- Self-explanatory graphic control panel, the workings steps can be understood immediately, even without operating instructions
 - no learning time = reduces costs
 - ideal for untrained users
 - visualised process avoids operating errors
- The 4 steps are carried out from left to right:
 - 1 Place the empty container onto the weighing plate and tare by pressing the TARE key
 - 2 Place the reference quantity for the goods to be counted into the container (5, 10 or 20 pieces)
 - 3 Confirm the selected reference quantity by pressing the key (5, 10 or 20)
 - 4 Pour in the goods to be counted. The number of pieces will immediately be shown in the display
- Precise counting: The automatic reference weight optimisation of reference weight gradually improves the average piece weight value
- Protective working cover included with delivery

Technical data

- Backlit LCD display, digit height 18 mm
- Dimensions weighing surface, Stainless Steel
 - A W×D 228×228 mm
 - B W×D 308×318 mm
 - C W×D 450×350 mm
- Dimensions of display device W×D×H 225×115×60 mm
- Permissible ambient temperature 10 °C/40 °C

Accessories

- Protective working cover over the display device, scope of delivery: 5 items, KERN DE-A12S05, **€ 40,-**
- Mount to fasten the display device to the platform, for models with weighing plate size B, C, can be reordered, KERN DE-A11N, **€ 35,-**
- Stand to elevate display device, height of stand approx. 480 mm, can be reordered, KERN DE-A10, **€ 100,-**
- Rechargeable battery pack external, operating time up to 30 h without backlight, charging time approx. 10 h, KERN KS-A01, **€ 160,-**
- Internal rechargeable battery pack, operating time up to 30 h without backlight, charging time approx. 10 h, KERN KB-A01N, **€ 50,-**
- Set for underfloor weighing, consists of platform, bow, hook, only for models with weighing plate B, KERN DS-A01, **€ 200,-**
- Further details, plenty of further accessories and suitable printers see *Accessories*

STANDARD

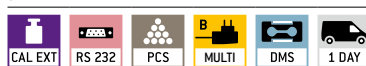

OPTION

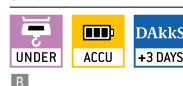

Model	Weighing capacity [Max] kg	Readability [d] g	Smallest part weight [Normal] g/piece	Counting resolution Points	Net weight approx. kg	Cable length approx. m	Weighing plate	Price excl. of VAT ex works €	Option	
									DAKkS KERN	DAKkS Calibr. Certificate €
CDS 4K0.02	4	0,02	0,2	200.000	6	2	A	560,-	963-127	78,-
CDS 15K0.05	15	0,05	0,5	300.000	8	2	B	490,-	963-128	94,-
CDS 16K0.1	16	0,1	1	160.000	8	2	B	470,-	963-128	94,-
CDS 30K0.1	30	0,1	1	300.000	8	2	B	560,-	963-128	94,-
CDS 30K0.1L	30	0,1	1	300.000	10	0,6	C	720,-	963-128	94,-
CDS 36K0.2L	36	0,2	2	180.000	10	0,6	C	710,-	963-128	94,-
CDS 60K0.2	60	0,2	2	300.000	10	0,6	C	720,-	963-129	116,-



High-resolution counting system with EC type approval to count the smallest parts in large quantities, maximum number of parts which can be displayed is 999,999

Features

- The highly accurate KERN CCA counting system can replace a whole range of individual balances, efficiently and at a reasonable price
- Thanks to EC type approval, it is also suitable for use in verified applications
- The balances are connected to one another with an RS-232 Y-cable, which also allows you to connect an end unit, such as, for example, signal lamps, barcode scanners or printers

Reference scale KERN

- This precision balance, which can be used as an individual balance, also fulfils the highest demands through connection with a high-capacity weighing bridge
- Programmable using numerical key pad:
 - required reference quantity
 - known reference weight
- Easy to use: All primary functions have their own key on the keypad

- Automatic internal adjustment, time-controlled every 2 h, guarantees high degree of accuracy and makes the balance independent of its location
- Capacity display: A bargraph display lights up to show how much of the weighing range is still available
- USB data interface for transferring weighing data to the PC, printer etc. Can only be used in combination with KERN DBS-A02 accessories
- Draught shield standard, Weighing space W×D×H 134×128×80 mm, 134×128×80 mm
- Protective working cover included with delivery

Quantity scale KERN IFS

- The high-accuracy quantity counting takes place on the weighing platform (= weighing bridge) KERN CCA. In this way even the smallest of parts can be counted in large volumes
- Tough industry standard suitable for use in harsh industrial applications
- Ergonomic display device with large keypad and high-contrast LCD display for easy entry and reading of, e.g., tare weights, reference weights, limit values etc.

- Three displays for weight display, reference weight, total pieces
- 100 item memories for master data such as reference weight, reference quantity, container weight (PRE-TARE) etc.
- Precise counting: The manual reference weight optimisation gradually improves the average value of the piece weight
- Totalising of pieces when counting
- Printout with date and time
- Aluminium singlepoint load cell (1×3000 e), protection against dust and water splashes IP65
- Protective working cover included with delivery

Technical data

Reference scale KERN EWJ

- Overall dimensions (incl. draught shield) W×D×H 220×340×321 mm
- Dimensions of weighing surface, stainless steel, Ø 120 mm
- Net weight 3,2 kg
- Connection cable approx. 1,5 m

Quantity scale KERN IFS

- Dimensions of weighing plate
 - A 300×240×110 mm
 - B 400×300×120 mm
 - C 500×400×140 mm
 - D 650×500×140 mm

Accessories

- Signal lamp for visual support of weighing with tolerance range, only in combination with CCA-A02, KERN CFS-A03, € 250,-
- Y-cable, RS-232, KERN CCA-A02, € 46,-

Reference scale KERN EWJ

- Protective working cover, scope of delivery: 5 items, KERN EWJ-A04S05, € 40,-
- Internal rechargeable battery pack, operating time up to 15h without backlight, charging time approx. 4h, KERN KFB-A01, € 35,-

Quantity scale KERN IFS

- Protective working cover, scope of delivery: 5 items, KERN KFB-A02S05, € 40,-
- Internal rechargeable battery pack, operating time up to 18 h without backlight, charging time approx. 12 h, Factory Option, KERN KFB-A01, € 35,-
- Further details, plenty of further accessories and suitable printers see *Accessories*

STANDARD

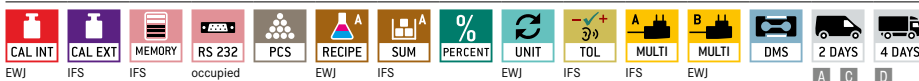

OPTION



FACTORY

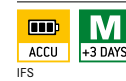

Model	Weighing capacity Quantity scale [Max] kg	Readability Quantity scale [d] g	Weighing plate	Weighing capacity Reference scale [Max] g	Readability Reference scale [d] g	Counting resolution Points	Smallest part weight [Normal] g/piece	Price excl. of VAT ex works €	Option	
									Verification	
KERN									KERN	€
Note: For applications that require verification, please order verification at the same time, initial verification at a later date is not possible. Verification at the factory, we need to know the full address of the location of use.										
CCA 6K-5M	3 6	1 2	A	600	0,01	30.000	0,2	890,-	965-228-216	121,-
CCA 10K-5M	6 15	2 5	A	600	0,01	75.000	0,2	890,-	965-228-216	121,-
CCA 30K-5M	15 30	5 10	B	600	0,01	150.000	0,2	960,-	965-228-216	121,-
CCA 60K-5M	30 60	10 20	B	600	0,01	300.000	0,2	960,-	965-229-216	159,-
CCA 100K-5M	60 150	20 50	C	600	0,01	750.000	0,2	1070,-	965-229-216	159,-
CCA 300K-5M	150 300	50 100	D	600	0,01	1.500.000	0,2	1250,-	965-229-216	159,-



Counting system to count the smallest parts in large quantities, maximum number of parts which can be displayed is 999,999

Features

- The highly accurate KERN CCS counting system can replace a whole range of individual balances, efficiently and at a reasonable price

Reference scale KERN CFS

- This professional counting scale, which can also be used as a stand-alone scale, meets the highest demands for accuracy, weighing capacity and volume of items, by being connected to a high-capacity weighing bridge
- Programmable using numerical key pad:
 - required reference quantity
 - known reference weight
- Three displays for weight display, reference weight, total pieces
- Memory (PLU) for 100 items with additional text, reference weight and tare weight, e.g. of a container
- Fill-to-target function: Target count or target weight can be programmed. When the target weight is reached there is an audible and visual signal
- Precise counting: The automatic reference weight optimisation of reference weight gradually improves the average piece weight value
- Protective working cover included with delivery

Quantity scale KERN

- The high-accuracy quantity counting takes place on the weighing platform (= weighing bridge) KERN CCS. In this way even the smallest of parts can be counted in large volumes

KFP-V20 IP67, KFU-V20

- Stainless steel weighing plate, painted steel base, for models with weighing plate size **A-E**
- Aluminium singlepoint load cell (1×3000 e), protection against dust and water splashes IP65

KFP-V20 IP67, KIP-V20M

- Weighing bridge made of non-slip corrugated steel plate, lacquered, for models with weighing plate size **I-K**
- 4 load cells, steel, silicone-coated, IP67

KFU-V20

- Load range: painted steel
- 4 load cells, alloy steel, silicone-coated, IP67

Technical data

Reference scale KERN CFS

- Overall dimensions W×D×H 315×350×180 mm
- Dimensions weighing surface, stainless steel
 - I** CFS 300-3: \varnothing 80 mm
 - CFS 3K-5, CFS 6K0.1: W×D 300×225 mm
- Draught shield standard for models with weighing plate size \varnothing 80 mm, weighing space B×T×H 158×143×64 mm
- Net weight approx. 2,6 kg

Quantity platforms, KERN KFP-V20 IP65

- Weighing plate dimensions W×D×H, stainless steel
 - A** 230×230×110 mm
 - B** 300×240×110 mm
 - C** 400×300×125 mm
 - D** 500×400×137 mm
 - E** 650×500×135 mm

Bulk weighing bridges, KFP-V20 IP67

- Weighing plate dimensions W×D×H, steel, painted
 - F** 1500×1250×80 mm

Bulk pallet load handling, KERN KFU-V20

- Weighing plate dimensions W×D×H, steel, painted
 - G** 840×1300×90 mm

Quantity platforms KERN KIP-V20

- Weighing plate dimensions W×D×H, stainless steel
 - H** 1000×1000×108 mm
 - I** 1500×1200×108 mm
 - J** 1500×1500×108 mm

- Connection cable approx.
 - A-E** 2,5 m
 - F-J** 5 m

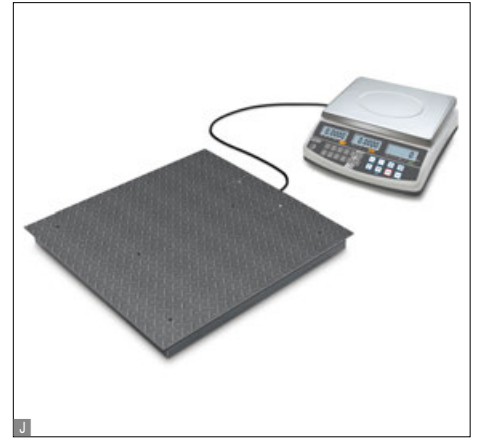

Accessories

- **2** Protective working cover, scope of delivery: 5 items, KERN CFS-A02S05, **€ 40,-**
- **3** Internal rechargeable battery pack, operating time up to 60 h without backlight, charging time approx. 12 h, KERN GAB-A04, **€ 40,-**
- **4** Signal lamp for visual support of weighing with tolerance range, only in combination with, KERN CFS-A03, **€ 250,-**
- **5** Y-cable for parallel connection of two terminal devices to the RS-232 interface on the scale, e.g. signal lamp and printer, KERN CFS-A04, **€ 35,-**
- Further details, plenty of further accessories and suitable printers see *Accessories*

I Information on other high-capacity bulk balances, such as, for example, pallet scales, drive-through scales or floor scales is available on request, for information on other counting systems with the KERN CFS reference balance (d = 0.1 g), please refer to the website

STANDARD



OPTION



Model	Weighing capacity Quantity scale [Max] kg	Readability Quantity scale [d] g	Weighing plate	Weighing capacity Reference scale [Max] g	Readability Reference scale [d] g	Counting resolution Points	Smallest part weight [Normal] g/piece	Price excl. of VAT ex works €	Option	
									DAKKS KERN	Calibr. Certificate €
CCS 6K-6	6	0,2	A	300	0,001	1.200.000	0,05	630,-	962-128-127	172,-
CCS 10K-6.	15	0,5	B	300	0,001	3.000.000	0,05	660,-	962-128-127	172,-
CCS 30K0.01.	30	1	C	3000	0,01	600.000	0,5	540,-	962-128-127	172,-
CCS 30K0.1.	30	1	C	6000	0,1	300.000	1	490,-	962-128-128	188,-
CCS 60K0.01.	60	2	C	3000	0,01	1.200.000	0,5	540,-	962-129-127	194,-
CCS 60K0.01L.	60	2	D	3000	0,01	1.200.000	0,5	620,-	962-129-127	194,-
CCS 60K0.1.	60	2	C	6000	0,1	600.000	1	495,-	962-129-128	210,-
CCS 60K0.1L.	60	2	D	6000	0,1	600.000	1	570,-	962-129-128	210,-
CCS 150K0.01.	150	5	D	3000	0,01	3.000.000	0,5	650,-	962-129-127	194,-
CCS 150K0.01L	150	5	E	3000	0,01	3.000.000	0,5	860,-	962-129-127	194,-
CCS 150K0.1.	150	5	D	6000	0,1	1.500.000	1	540,-	962-129-128	210,-
CCS 150K0.1L	150	5	E	6000	0,1	1.500.000	1	820,-	962-129-128	210,-
CCS 300K0.01	300	10	E	3000	0,01	6.000.000	0,5	860,-	962-129-127	194,-
CCS 300K0.1	300	10	E	6000	0,1	3.000.000	1	790,-	962-129-128	210,-
CCS 600K-1S*	600	200	H	6000	0,1	6.000.000	1	1400,-	962-130-127	245,-
CCS 600K-1*	600	200	I	6000	0,1	6.000.000	1	1650,-	962-130-127	245,-
CCS 600K-2U*	600	200	G	3000	0,01	12.000.000	0,5	1490,-	962-130-127	245,-
CCS 1T-4S*	1500	500	H	6000	0,1	15.000.000	1	1400,-	962-130-128	260,-
CCS 1T-4*	1500	500	I	6000	0,1	15.000.000	1	1650,-	962-130-128	260,-
CCS 1T-1L*	1500	500	F	6000	0,1	15.000.000	1	1880,-	962-130-128	260,-
CCS 1T-1U*	1500	500	G	6000	0,1	15.000.000	1	1430,-	962-130-128	260,-
CCS 3T-3*	3000	1000	I	6000	0,1	30.000.000	1	1650,-	962-132-128	530,-
CCS 3T-3L*	3000	1000	J	6000	0,1	30.000.000	1	1850,-	962-132-128	530,-

KERN Service Portal

[www.kern-sohn.com/
serviceportal](http://www.kern-sohn.com/serviceportal)



Technical contact enquiries this is where you can ask us a technical question about your product or request technical support for your product



Fast service
We deliver needed spare parts usually within 48 hours plus transport



At any time **status inquiry** from your device with your repair number and your password for your repair process

The KERN Service Portal – We won't let you down!

With a device from KERN you can be sure of the highest quality. But if you have any complaints at all, you can register your repair at www.kern-sohn.com/serviceportal and download a consignment note for your service return.

Your advantages: Accelerated processing as well as online tracking of the repair status.

Our reliable KERN service personnel will do everything within their power to make sure your precision balances and measuring devices are back in operation as quickly as possible.



Parcel scales/Platform scales

Here you'll find a complete summary of the KERN platform scales series and their positioning within the platform scales segment on the basis of application, price-performance ratio and functional volume



Precision platform scales

	★★★★
DS	★★★
	★

STAINLESS STEEL PLATFORM SCALES

▶ Page 71	SXS	▶ Page 72	★★★★
SFB			★★★
			★

PLATFORM SCALES WITH STAINLESS STEEL DISPLAY

	IXS	★★★★
SFE		★★★
		★

INDUSTRIAL PLATFORM SCALES

	IKT	★★★★	
EOC	IOB	IOS	★★★
			★★
		IFS	▶ Page 85
			★

PARCEL SCALES

	DE	★★★★
EOB	EOS	★★★
		★★
EOE		★

KERN IOC

Page 102

- Industry 4.0: A wide range of (optional) data interfaces allows that it is easy to transfer weighing data
- Practical dual-range scale – high precision paired with large weighing capacities
- Protected against water splashes through IP65 rating

from €
295,-



Quick-Finder Parcel scales/Platform scales

Readability [d] g	Weighing capacity [Max] kg	Weighing plate W×D×H mm	Model KERN	Price excl. of VAT ex works €	Page	DAYS	M	CAL EXT	ALIBI	RS 232	KCP PROTOCOL	PCS	IP	BATT	ACCU	For an explanation on the pictos, see front flap									
50	150	315×305×57	EOB 150K50	152,-	96	1		●							●										
50	150	550×550×58	EOB 150K50L	330,-	96	1		●							●										
50	150	950×500×58	EOB 150K50XL	400,-	96	1		●							●										
50	150	950×500×58	EOS 150K50XL	395,-	97	1		●							●										
50	150	400×300×130	SFE 100K-2NM	430,-	105	1	○	●					●							●					
50	150	500×400×140	SFE 100K-2LNM	520,-	105	1	○	●					●							●					
50	150	650×500×140	SFE 100K-2XLNM	660,-	105	1	○	●					●							●					
50 100	150 300	522×403×83	DE 300K50D	315,-	98	1		●		●		●	●	●	●					○					
50 100	150 300	650×500×95	DE 300K50DL	450,-	98	1		●		●		●	●	●	●					○					
50 100	150 300	500×400×120	EOC 300K-2	330,-	100	1		●		●	●	●	●	●	●					○					
50 100	150 300	600×500×150	EOC 300K-2L	470,-	100	1		●		●	●	●	●	●	●					○					
50 100	150 300	650×500×150	IOC 300K-2M	650,-	102	1	○	●	○	●	●	●	●	●	●					○					
50 100	150 300	650×500×142	IFB 300K50DM	670,-	103	1	○	●		●	●	●	●	●	●					○					
50 100	150 300	650×500×133,5	IXS 300K-2M	800,-	106	2*	○	●		○		●	●	●						○					
100	300	315×305×57	EOE 300K100	135,-	95	1		●							●										
100	300	550×550×58	EOE 300K100L	270,-	95	1		●							●										
100	300	950×500×58	EOE 300K100XL	310,-	95	1		●							●										
100	300	315×305×57	EOB 300K100A	152,-	96	1		●							●										
100	300	550×550×58	EOB 300K100L	330,-	96	1		●							●										
100	300	950×500×58	EOB 300K100XL	400,-	96	1		●							●										
100	300	950×500×58	EOS 300K100XL	395,-	97	1		●							●										
100	300	650×500×140	SFE 300K-1LNM	660,-	105	1	○	●					●							●					
100 200	300 600	800×600×200	IOC 600K-1M	790,-	102	2*	○	●	○	●	●	●	●	●	●					○					
100 200	300 600	800×600×200	IFB 600K-1M	930,-	103	2*	○	●		●	●	●	●	●	●					○					

* Shipment via freight forwarder. Please ask for dimensions, gross weight, shipping costs

● = standard ○ = option



Parcel scales with big platform for fast and easy weighing in the office, production, dispatch etc.

Features

- High mobility: thanks to battery operation, compact, lightweight construction, it is suitable for the use in several locations
- Wall mount for display device, standard
- Hold function: When the weighing conditions are unstable, a stable weight is calculated determining an average value

Technical data

- Large LCD display, digit height 25 mm
- Weighing plate dimensions, steel, painted W×D×H
 - A 315×305×57 mm
 - B 550×550×58 mm
 - C 550×550×58 mm
- Dimensions of display device W×D×H 235×114×51 mm
- Optional battery operation, 4×1.5 V AA not included in scope of delivery, operating time up to 100 h
- Permissible ambient temperature 5 °C/35 °C

Accessories

- Protective working cover over the display device, scope of delivery: 5 items, KERN EOB-A04BS05, **€ 40,-**
- Stand to elevate display device Column height approx. 480 mm KERN EOB-A01N, **€ 50,-**
- Stand to elevate display device, height of stand approx. 1000 mm, can be reordered, KERN EOB-A02B, **€ 80,-**
- External universal mains adapter, with universal input and optional input socket adapters for EU, GB, USA, KERN YKA-16, **€ 40,-**

STANDARD

CAL EXT UNIT MOVE BATT MULTI DMS 1 DAY

OPTION

DAKKS +3 DAYS

Model	Weighing capacity [Max] kg	Readability [d] g	Reproducibility g	Weighing plate	Net weight approx. kg	Cable length approx. m	Price excl. of VAT ex works €	Option	
								DAKKS KERN	DAKKS Calibr. Certificate €
EOE 10K-3	15	5	5	A	4,0	1,8	135,-	963-128	94,-
EOE 30K-2	35	10	10	A	4,0	1,8	135,-	963-128	94,-
EOE 60K-2	60	20	20	A	3,8	1,8	135,-	963-129	116,-
EOE 60K-2L	60	20	20	B	14	2,7	270,-	963-129	116,-
EOE 100K-2	150	50	50	A	4	1,8	135,-	963-129	116,-
EOE 150K50L	150	50	50	B	14	2,7	270,-	963-129	116,-
EOE 150K50XL	150	50	50	C	18	2,7	310,-	963-129	116,-
EOE 300K100	300	100	100	A	3,6	1,8	135,-	963-129	116,-
EOE 300K100L	300	100	100	B	14	2,7	270,-	963-129	116,-
EOE 300K100XL	300	100	100	C	18	2,7	310,-	963-129	116,-

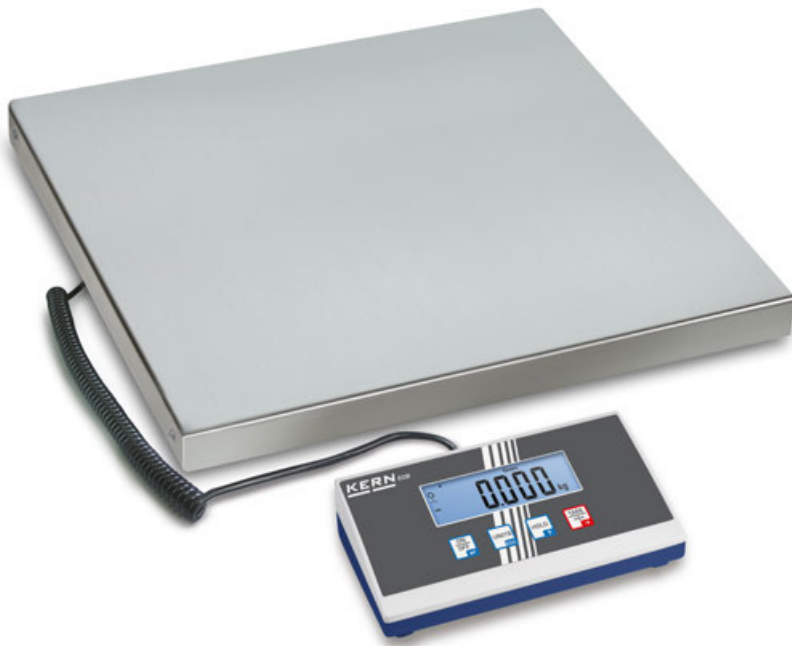

Allround parcel scale with robust stainless steel weighing plate – also with XL platform and large weighing ranges

Features

- Weighing plate stainless steel, painted steel base
- Simple and convenient 4-key operation
- Wall mount for display device, standard
- Hold function: When the weighing conditions are unstable, a stable weight is calculated determining an average value
- Protective working cover included with delivery
- Universal external mains adapter included with delivery

Technical data

- Large LCD display, digit height 25 mm
- Weighing plate dimensions, stainless steel W×D×H
 - A 315×305×57 mm
 - B 550×550×58 mm, see larger picture
 - C 950×500×58 mm
- Dimensions of display device W×D×H 235×114×51 mm
- Cable length of display device approx. 1,8 m
- Optional battery operation, 4×1.5 V AA not included in scope of delivery, operating time up to 60 h
- Permissible ambient temperature 5 °C/35 °C

Accessories

- Protective working cover over the display device, scope of delivery: 5 items, KERN EOB-A04BS05, **€ 40,-**
- 1 Stand to elevate display device, height of stand approx. 1000 mm, can be reordered, KERN EOB-A02B, **€ 80,-**
- 2 Stand to elevate display device Column height approx. 480 mm, KERN EOB-A01N, **€ 50,-**
- Non-slip rubber mat W×D×H 945×505×5 mm, KERN EOE-A01, **€ 45,-**

10

STANDARD

CAL EXT UNIT MOVE BATT MULTI DMS 1 DAY

OPTION

DAKKS +3 DAYS

Model	Weighing capacity [Max] kg	Readability [d] g	Reproducibility g	Linearity g	Net weight approx. kg	Weighing plate	Price excl. of VAT ex works €	Option	
								DAKKS	DAKKS Calibr. Certificate
KERN								DAKKS KERN	€
EOB 15K5	15	5	5	± 10	3,8	A	152,-	963-128	94,-
EOB 35K10	35	10	10	± 20	3,8	A	152,-	963-128	94,-
EOB 60K20	60	20	20	± 40	3,8	A	152,-	963-129	116,-
EOB 60K20L	60	20	20	± 40	15	B	330,-	963-129	116,-
EOB 150K50	150	50	50	± 100	3,8	A	152,-	963-129	116,-
EOB 150K50L	150	50	50	± 100	11	B	330,-	963-129	116,-
EOB 150K50XL	150	50	50	± 100	17	C	400,-	963-129	116,-
EOB 300K100A	300	100	100	± 200	4,6	A	152,-	963-129	116,-
EOB 300K100L	300	100	100	± 200	14	B	330,-	963-129	116,-
EOB 300K100XL	300	100	100	± 200	19	C	400,-	963-129	116,-



Heavy duty parcel and veterinary platform scale with extra large stainless steel weighing plate

Features

- Weighing plate stainless steel, painted steel base
- Simple and convenient 4-key operation
- Wall mount for display device, standard
- Hold function: When the weighing conditions are unstable, a stable weight is calculated determining an average value: The scale can be easily transported using rollers and a handle and does not require much storage space
- Protective working cover included with delivery: Non-slip rubber mat included with delivery
- Universal external mains adapter included with delivery

Technical data

- Large LCD display, digit height 25 mm
- **A** Weighing plate dimensions, stainless steel W×D×H, 950×500×58 mm
- Dimensions of display device W×D×H 235×114×51 mm
- Cable length of display device approx. 2,7 m
- Optional battery operation, 4×1.5 V AA not included in scope of delivery, operating time up to 60 h
- Permissible ambient temperature 5 °C/35 °C

Accessories

- Protective working cover over the display device, scope of delivery: 5 items, KERN EOB-A04BS05, **€ 40,-**
- Stand to elevate display device, height of stand approx. 1000 mm, can be reordered, KERN EOB-A02B, **€ 80,-**
- Non-slip rubber mat W×D×H 900×550×5 mm, KERN EOS-A01, **€ 35,-**

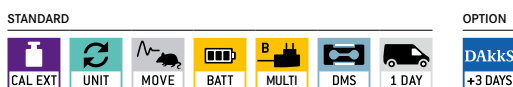

Model	Weighing capacity [Max] kg	Readability [d] g	Reproducibility g	Linearity g	Net weight approx. kg	Price excl. of VAT ex works €	Option	
							DAkKS KERN	DAkKS Calibr. Certificate €
KERN EOS 150K50XL	150	50	50	± 100	17	395,-	963-129	116,-
KERN EOS 300K100XL	300	100	100	± 200	17	395,-	963-129	116,-



10

The long lasting story of success with dust and spray protected display device



Piece counting



Animal weighing

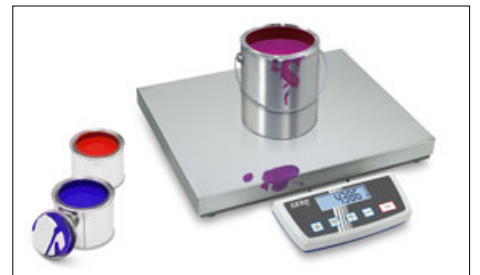

Recipe-weighing



Features

- High mobility: thanks to battery operation/ rechargeable battery operation (optional), compact, lightweight construction, it is suitable for the use in several locations (production, warehouse, dispatch department etc.)
- Display device flexible positioning e. g. free-standing or screwed to the wall
- **1** Display device: Plastics, protection against dust and water splashes IP65
- Weighing plate stainless steel, painted steel base
- PRE-TARE function for manual subtraction of a known container weight, useful for checking fill-levels
- With the recipe function you can weigh the different ingredients of a mixture. As a check, you can also call up the total weight of all the ingredients
- Freely programmable weighing unit, e.g. display direct in special units such as length of thread g/m, paper weight g/m², or similar

- Protective working cover included with delivery

Technical data

- Large backlit LCD display, digit height 25 mm
- Weighing plate dimensions, stainless steel W×D×H
 - A** 318×308×75 mm
 - B** 318×308×88 mm
 - C** 522×406×98 mm, see larger picture
 - D** 522×403×83 mm
 - E** 650×500×89 mm
- Dimensions of display device, W×D×H 225×110×45 mm
- Optional battery operation, 9 V block not included in scope of delivery, operating time up to 12 h
- Permissible ambient temperature 5 °C/35 °C

Accessories

- Protective working cover over the display device, scope of delivery: 5 items, KERN DE-A12S05, **€ 40,-**
- Internal rechargeable battery pack, operating time up to 30 h without backlight, charging time approx. 10 h, KERN NDE-A02, **€ 50,-**
- Mount to fasten the display device to the platform, for models with weighing plate size **B**, **C**, can be reordered, KERN DE-A11N, **€ 35,-**
- Wall mount for display device, KERN DE-A13, **€ 30,-**
- **2** Stand to elevate display device, height of stand approx. 480 mm, can be reordered, KERN DE-A10, **€ 100,-**
- Individual header data: the free software SHM-01 can be used to print header lines on the printout when using printers YKN-01 and YKB-01N
- Further details, plenty of further accessories and suitable printers see *Accessories*

STANDARD



OPTION



Model	Weighing capacity [Max] kg	Readability [d] g	Reproducibility g	Linearity g	Smallest part weight [Normal] g/piece	Cable length approx. m	Net weight approx. kg	Weighing plate	Price excl. of VAT ex works €	Option	
										DAkKS KERN	DAkKS Calibr. Certificate €
Dual-range balance switches automatically to the next largest weighing capacity [Max] and readability [d]											
DE 6K1D	3 6	1 2	1 2	± 3 6	40	1,4	4,8	A	185,-	963-128	94,-
DE 15K2D	6 15	2 5	2 5	± 6 15	100	1,4	4,8	A	185,-	963-128	94,-
DE 35K5D	15 35	5 10	5 10	± 15 30	100	1,4	4,8	A	185,-	963-128	94,-
DE 35K5DL	15 35	5 10	5 10	± 15 30	100	1,4	16	D	315,-	963-128	94,-
DE 60K10D	30 60	10 20	10 20	± 30 60	200	1,4	4,8	A	185,-	963-129	116,-
DE 60K10DL	30 60	10 20	10 20	± 30 60	200	1,4	16	D	315,-	963-129	116,-
DE 150K20D	60 150	20 50	20 50	± 60 150	400	1,5	5	A	195,-	963-129	116,-
DE 150K20DL	60 150	20 50	20 50	± 60 150	400	1,5	16	D	315,-	963-129	116,-
DE 150K20DXL	60 150	20 50	20 50	± 60 150	400	1,4	28	E	450,-	963-129	116,-
DE 300K50D	150 300	50 100	50 100	± 150 300	2000	1,25	16	D	315,-	963-129	116,-
DE 300K50DL	150 300	50 100	50 100	± 150 300	2000	1,05	28	E	450,-	963-129	116,-
Dual-range balance with high resolution readability											
DE 6K0.5A	6	0,5	0,5	± 1,5	10	1,4	4,8	A	215,-	963-128	94,-
DE 12K1A	12	1	1	± 3	20	1,4	4,8	A	215,-	963-128	94,-
DE 24K2A	24	2	2	± 6	40	1,4	4,8	A	215,-	963-128	94,-
DE 60K5A	60	5	5	± 15	100	1,4	4,8	A	215,-	963-129	116,-
DE 120K10A	120	10	10	± 30	200	1,4	5,0	A	215,-	963-129	116,-
DE 15K0.2D	6 15	0,2 0,5	0,2 0,5	± 0,8 2	4	1	4	B	335,-	963-128	94,-
DE 35K0.5D	15 35	0,5 1	0,5 1	± 2 4	10	1	7	B	335,-	963-128	94,-
DE 60K1D	30 60	1 2	1 2	± 4 8	20	1,47	7	B	335,-	963-129	116,-
DE 60K1DL	30 60	1 2	1 2	± 4 8	20	1,4	15	C	435,-	963-129	116,-
DE 150K2D	60 150	2 5	2 5	± 8 20	40	1,6	7	B	340,-	963-129	116,-
DE 150K2DL	60 150	2 5	2 5	± 8 20	40	1,4	15	C	435,-	963-129	116,-
DE 300K5DL	150 300	5 10	5 10	± 20 40	100	1,4	15	C	435,-	963-129	116,-

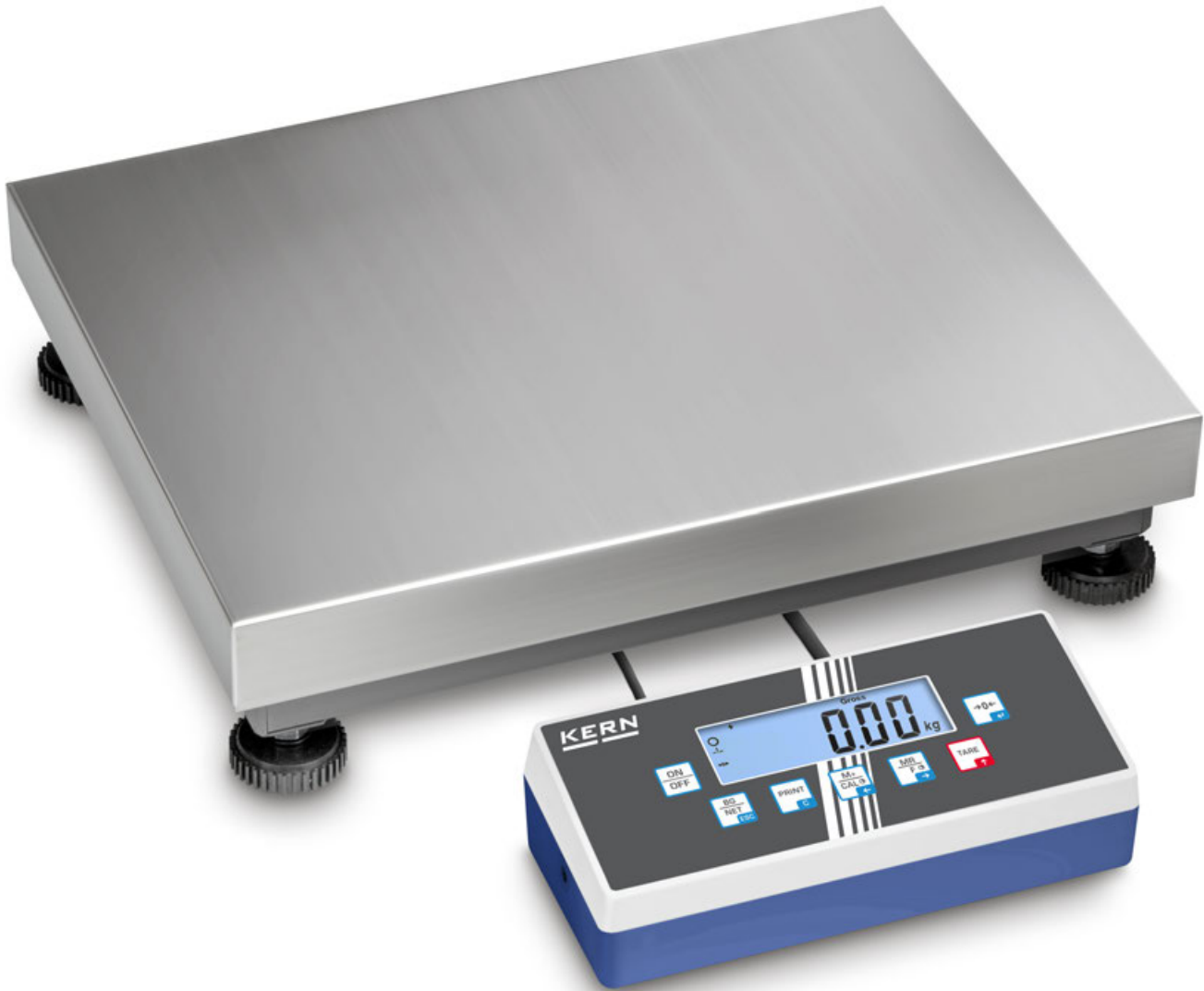

10

Robust and high-resolution platform scale with practical Flip/Flop display device for greatest ease of use



Weighing instead of counting!
Because the counting function is so easy to use, you can rapidly record large numbers of small parts – which saves time and money

Practical Flip/Flop display device: flexible positioning e.g. free-standing or screwed to the wall (optional). By rotating the upper housing shell you can determine the angle of the display as well as the cable outlet.

Factory Option ex works for an additional cost, delivery time + 2 working days, KERN KIB-M01, see Accessories on the right, please indicate when placing your order

Industrial platform scale KERN EOC

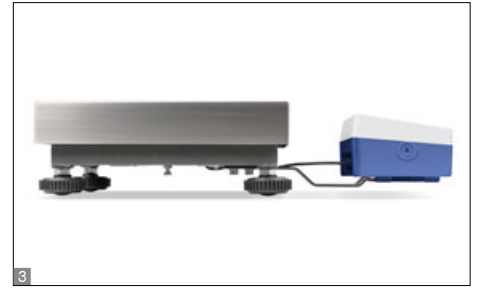

Features

- High mobility: thanks to rechargeable battery operation (optional), compact, lightweight construction, it is suitable for the use in several locations (laboratory, production, quality control, commissioning etc.)
- **1** Platform: weighing plate stainless steel, painted steel base, silicone-coated aluminium load cell, protection against dust and water splashes IP65. Level indicator and levelling feet for precise levelling of the scale, fitted as standard, to give the most accurate weighing result
- Weighing with tolerance range (checkweighing): a visual and audible signal helps with portioning, dispensing or grading
- Hold function: When the weighing conditions are unstable, a stable weight is calculated determining an average value
- Benchtop stand incl. wall mount for display device as standard
- Protective working cover included with delivery

- Searching and remote control of the balance using external control devices or computers with the KERN Communication Protocol (KCP). KCP is a standardised interface command structure for KERN balances and other instruments which allows you to recall and manage all relevant parameters and device functions. You can therefore simply connect KERN devices with KCP to computers, industrial control systems and other digital systems. In a large number of cases the KCP is compatible with the MT-SICS protocol.

Technical data

- Large backlit LCD display, digit height 25 mm
- Weighing plate dimensions W×D×H
 - A** 300×300×110 mm
 - B** 500×400×120 mm, see larger picture
 - C** 600×500×150 mm
 - D** 950×500×60 mm
- Dimensions of display device W×D×H 268×115×80 mm
- Permissible ambient temperature -10 °C/40 °C

Accessories

- Protective working cover, scope of delivery: 5 items, KERN EOC-A01S05, **€ 40,-**
- Internal rechargeable battery pack, operating time up to 43 h without backlight, charging time approx. 3 h, KERN KFB-A01, **€ 35,-**
- **2** Stand to elevate display device, height of stand approx. 330 mm, KERN EOC-A05, **€ 60,-**
- **3** Mount to fasten the display device to the platform, KERN EOC-A03, **€ 30,-**
- Benchtop stand incl. wall mount for display device, KERN EOC-A04, **€ 30,-**
- Conversion of the display device, to move the cable outlet to the front of the display device, ideal e.g. for subsequent wall installation of the display device (standard configuration ex works: rear outlet), Factory Option, delivery time + 2 working days, KERN KIB-M01, **€ 95,-**

STANDARD

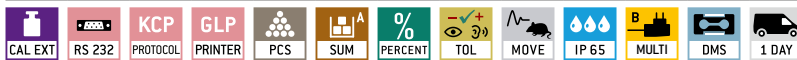

OPTION



Model	Weighing capacity [Max] kg	Readability [d] g	Smallest part weight [Normal] g/piece	Cable length approx. m	Net weight approx. kg	Weighing plate	Price excl. of VAT ex works €	Option	
								DAkKS	Calibr. Certificate
KERN								DAkKS	€
EOC 6K-3	3 6	1 2	2,5	3	6	A	270,-	963-128	94,-
EOC 10K-3	6 12	2 5	5	3	7	A	270,-	963-128	94,-
EOC 30K-3	15 35	5 10	10	3	6	A	280,-	963-128	94,-
EOC 30K-3L	15 35	5 10	10	3	9	B	330,-	963-128	94,-
EOC 60K-2	30 60	10 20	20	3	6	A	280,-	963-129	116,-
EOC 60K-2L	30 60	10 20	20	3	9	B	330,-	963-129	116,-
EOC 100K-2	60 150	20 50	50	3	6	A	280,-	963-129	116,-
EOC 100K-2L	60 150	20 50	50	3	9	B	330,-	963-129	116,-
EOC 100K-2XL	60 150	20 50	50	3	19	C	470,-	963-129	116,-
EOC 100K-2XXL	60 150	20 50	100	0,7 - 2,7	26	D	490,-	963-129	116,-
EOC 300K-2	150 300	50 100	100	3	9	B	330,-	963-129	116,-
EOC 300K-2L	150 300	50 100	100	3	19	C	470,-	963-129	116,-
Dual-range balance switches automatically to the next largest weighing capacity [Max] and readability [d]									
EOC 6K-4A	6	0,5	2,5	3	6	A	290,-	963-128	94,-
EOC 10K-3A	12	1	5	3	7	A	290,-	963-128	94,-
EOC 20K-3A	24	2	10	3	6	A	290,-	963-128	94,-
EOC 60K-3A	60	5	20	3	6	A	290,-	963-129	116,-
EOC 100K-2A	120	10	50	3	9	B	330,-	963-129	116,-
EOC 10K-4	6 15	0,2 0,5	5	3	7	A	310,-	963-128	94,-
EOC 30K-4S	15 35	0,5 1	10	3	9	A	310,-	963-128	94,-
EOC 30K-4	15 35	0,5 1	10	3	9	B	340,-	963-128	94,-
EOC 60K-3	30 60	1 2	20	3	6	A	310,-	963-129	116,-
EOC 60K-3L	30 60	1 2	20	3	9	B	340,-	963-129	116,-
EOC 100K-3	60 150	2 5	50	3	7	A	310,-	963-129	116,-
EOC 100K-3L	60 150	2 5	50	3	9	B	340,-	963-129	116,-
EOC 300K-3	150 300	5 10	100	3	9	B	340,-	963-129	116,-

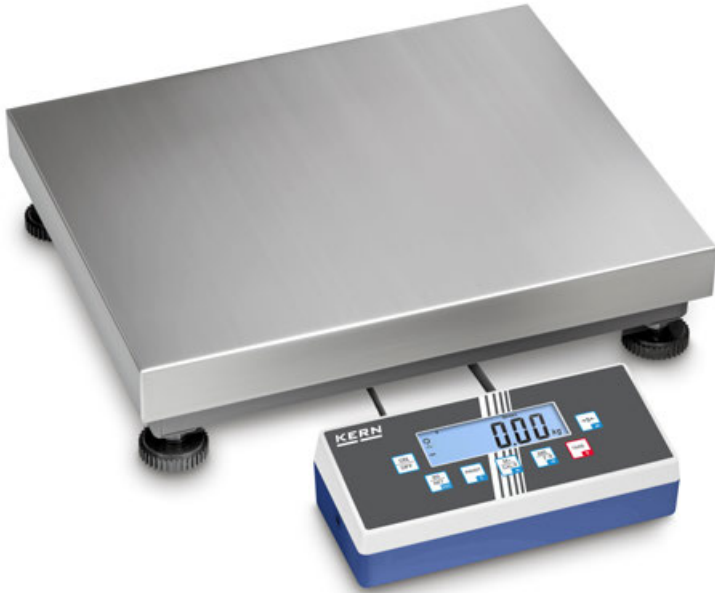

Allround platform scale with a wide range of communication options and EC type approval [M]

Features

- Industry 4.0: A wide range of (optional) data interfaces allows that it is easy to transfer weighing data to tablets, laptops, PCs, networks, Smartphones, printers, etc.
- High mobility: thanks to rechargeable battery operation (optional), compact, lightweight construction, it is suitable for the use in several locations (laboratory, production, quality control, commissioning etc.)
- Platform: weighing plate stainless steel, painted steel base, silicone-coated aluminium load cell, protection against dust and water splashes IP65
- Level indicator and levelling feet for precise levelling of the scale, fitted as standard, to give the most accurate weighing result
- Searching and remote control of the balance using external control devices or computers with the KERN Communication Protocol (KCP). KCP is a standardised interface command structure for KERN balances and other instruments which allows you to recall and manage all relevant parameters and device functions. You can therefore simply connect KERN devices with KCP to computers,

industrial control systems and other digital systems. In a large number of cases the KCP is compatible with the MT-SICS protocol.

Technical data

- Large LCD display, digit height 25 mm
- Weighing plate dimensions W×D×H
 - A 300×240×110 mm
 - B 300×300×110 mm
 - C 400×300×110 mm
 - D 500×400×120 mm, see larger picture
 - E 650×500×150 mm
 - F 800×600×200 mm
- Dimensions of display device W×D×H 268×115×80 mm
- Permissible ambient temperature -10 °C/40 °C

Accessories

- Protective working cover, scope of delivery: 5 items, KERN EOC-A01S05, € 40,-
- Stand to elevate display device, height of stand approx. 330 mm, KERN EOC-A05, € 60,-
- Mount to fasten the display device to the platform, can be retrofitted, KERN EOC-A03, € 30,-

- Benchtop stand incl. wall mount for display device, KERN EOC-A04, € 30,-
- Internal rechargeable battery pack, operating time up to 26 h with backlight, charging time approx. 3 h, KERN KFB-A01, € 35,-
- USB data interface, for transferring weighing to the PC, printer etc., KERN KIB-A03, € 120,-
- Bluetooth data interface for wireless data transfer to PC or tablets, must be ordered at purchase, not possible in combination with verification, KERN KIB-A04, € 110,-
- WiFi interface for wireless connection of the balance to networks and WiFi capable devices, such as tablets, laptops or smartphones, continuous data transfer, must be ordered at purchase, KERN KIB-A10, € 120,-
- Ethernet data interface, to connect an IP-based Ethernet network, continuous data transfer, must be ordered at purchase, KERN KIB-A02, € 150,-
- Alibi memory, including USB interface for exporting weighing results to external data storage media, such as, for example, USB sticks, hard drives, etc., KERN KIB-A01, € 150,-
- Signal lamp, including interface, for visual support of weighing with tolerance range, must be ordered at purchase, KERN KIB-A06, € 370,-
- Verification plug, for verified balances this enables you to separate the display device and platform without affecting the verification, e.g. for installing the scale in a packing and dispatch table, pit frame etc. at a later date. Please order this at the same time as you purchase your scale, KERN KIB-A12, € 150,-
- Conversion of the display device, to move the cable outlet to the front of the display device, ideal e.g. for subsequent wall installation of the display device (standard configuration ex works: rear outlet), Factory Option, delivery time + 2 working days, KERN KIB-M01, € 95,-
- Note: In addition to the RS 232 data interface integrated as standard, only one further data interface can be fitted and operated

STANDARD

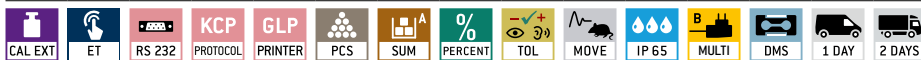

OPTION

FACTORY

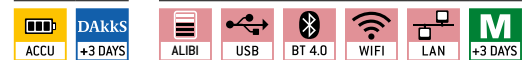

Model	Weighing capacity [Max] kg	Readability [d] g	Verification value [e] g	Minimal load [Min] g	Weighing plate	Price excl. of VAT ex works €	Option			
							Verification		DAkkS Calibr. Certificate	
							M	KERN	€	DAkkS KERN
KERN IOC 6K-3M	3 6	1 2	1 2	20 40	B	320,-	965-228	70,-	963-128	94,-
KERN IOC 10K-3M	6 15	2 5	2 5	40 100	A	295,-	965-228	70,-	963-128	94,-
KERN IOC 10K-3LM	6 15	2 5	2 5	40 100	C	360,-	965-228	70,-	963-128	94,-
KERN IOC 30K-3M	15 30	5 10	5 10	100 200	C	360,-	965-228	70,-	963-128	94,-
KERN IOC 60K-2M	30 60	10 20	10 20	200 400	C	370,-	965-229	93,-	963-129	116,-
KERN IOC 60K-2LM	30 60	10 20	10 20	200 400	D	465,-	965-229	93,-	963-129	116,-
KERN IOC 100K-2M	60 150	20 50	20 50	400 1000	D	465,-	965-229	93,-	963-129	116,-
KERN IOC 100K-2LM	60 150	20 50	20 50	400 1000	E	620,-	965-229	93,-	963-129	116,-
KERN IOC 300K-2M	150 300	50 100	50 100	1000 2000	E	650,-	965-229	93,-	963-129	116,-
KERN IOC 600K-1M	300 600	100 200	100 200	2000 4000	F	790,-	965-230	132,-	963-130	165,-

* Verification not in combination with KERN KIB-A02, KIB-A03, KIB-A04, KIB-A10

Price reduction



Accessories

- Protective working cover, scope of delivery: 5 items, KERN KFB-A02S05, **€ 40,-**
- Stand to elevate display device, for models with weighing plate size
 - A - ▫ E: Height of stand approx. 330 mm, KERN IFB-A01, **€ 50,-**
 - D, ▫ 2: Height of stand approx. 600 mm, KERN IFB-A02, **€ 60,-**
 - A - ▫ F: Height of stand approx. 800 mm, Stand to elevate display device Column KERN BFS-A07, **€ 120,-**
- Internal rechargeable battery pack, operating time up to 35 h, without backlight, charging time approx. 12 h, must be ordered at purchase, KERN KFB-A01, **€ 35,-**
- Bluetooth data interface for wireless data transfer to PC or tablets, must be ordered at purchase, not in combination with verification, KERN KFB-A03, **€ 130,-**
- Analogue module, must be ordered at purchase, not possible in combination with signal lamp 0-10 V: KERN KFB-A04, **€ 95,-**
4-20 mA: KERN KFB-A05, **€ 95,-**
- Signal lamp for visual support of weighing with tolerance range, only in combination with, KERN CFS-A03, **€ 250,-**
- Y-cable for parallel connection of two terminal devices to the RS-232 interface on the scale, e.g. signal lamp and printer, KERN CFS-A04, **€ 35,-**

High-resolution industrial scale in heavy version with EC type approval [M], now also up to [Max] 600 kg

Features

- Tough industry standard suitable for use in harsh industrial applications
- 1 Platform: weighing plate stainless steel, painted steel base, silicone-coated aluminium load cell, protection against dust and water splashes IP65
- Benchtop stand incl. wall mount for display device as standard
- Protective working cover included with delivery

Technical data

- Large backlit LCD display, digit height 52 mm
- Weighing plate dimensions, stainless steel W×D×H
 - A 230×230×110 mm, ▫ B 300×240×110 mm
 - C 400×300×128 mm, ▫ D 500×400×130 mm
 - E 650×500×142 mm, ▫ F 800×600×200 mm
- Dimensions of display device W×D×H 230×230×360 mm
- Cable length of display device approx. 3 m
- Permissible ambient temperature -10 °C/40 °C

STANDARD

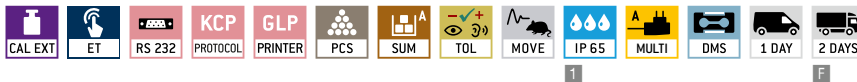

OPTION

FACTORY



Model	Weighing capacity [Max] kg	Readability [d] g	Verification value [e] g	Minimal load [Min] g	Net weight approx. kg	Weighing plate	Price excl. of VAT ex works €	Option				
								Verification	DAkkS	Calibr.	Certificate	
KERN								M	KERN	€	DAkkS KERN	€
IFB 3K-4	3	0,1	-	-	4,6	A	350,-	-	-	-	963-127	78,-
IFB 6K-4S	6	0,2	-	-	4,6	A	340,-	-	-	-	963-128	94,-
IFB 6K-4	6	0,2	-	-	5	B	350,-	-	-	-	963-128	94,-
IFB 10K-4	15	0,5	-	-	5	B	340,-	-	-	-	963-128	94,-
IFB 10K-4L	15	0,5	-	-	8	C	390,-	-	-	-	963-128	94,-
IFB 30K-3	30	1	-	-	8	C	390,-	-	-	-	963-128	94,-
IFB 60K-3	60	2	-	-	8	C	390,-	-	-	-	963-129	116,-
IFB 60K-3L	60	2	-	-	11	D	490,-	-	-	-	963-129	116,-
IFB 100K-3	150	5	-	-	11	D	490,-	-	-	-	963-129	116,-
IFB 100K-3L	150	5	-	-	20	E	690,-	-	-	-	963-129	116,-
IFB 300K-2	300	10	-	-	20	E	690,-	-	-	-	963-129	116,-
IFB 600K-2	600	20	-	-	44	F	790,-	-	-	-	963-130	165,-
Dual-range balance switches automatically to the next largest weighing capacity [Max] and readability [d]												
IFB 6K-3SM	3 6	1 2	1 2	20 40	4,6	A	350,-	965-228	70,-	-	963-128	94,-
IFB 6K1DM	3 6	1 2	1 2	20 40	5	B	335,-	965-228	70,-	-	963-128	94,-
IFB 15K2DM	6 15	2 5	2 5	40 100	5	B	335,-	965-228	70,-	-	963-128	94,-
IFB 15K2DLM	6 15	2 5	2 5	40 100	8	C	400,-	965-228	70,-	-	963-128	94,-
IFB 30K5DM	15 30	5 10	5 10	100 200	8	C	390,-	965-228	70,-	-	963-128	94,-
IFB 60K10DM	30 60	10 20	10 20	200 400	8	C	410,-	965-229	93,-	-	963-129	116,-
IFB 60K10DLM	30 60	10 20	10 20	200 400	11	D	510,-	965-229	93,-	-	963-129	116,-
IFB 150K20DM	60 150	20 50	20 50	400 1000	11	D	495,-	965-229	93,-	-	963-129	116,-
IFB 150K20DLM	60 150	20 50	20 50	400 1000	20	E	660,-	965-229	93,-	-	963-129	116,-
IFB 300K50DM	150 300	50 100	50 100	1000 2000	20	E	670,-	965-229	93,-	-	963-129	116,-
IFB 600K-1M	300 600	100 200	100 200	2000 4000	44	F	930,-	965-230	132,-	-	963-130	165,-

Note: For applications that require verification, please order verification at the same time, initial verification at a later date is not possible. Verification at the factory, we need to know the full address of the location of use.

Price reduction



Precision industrial scale with laboratory accuracy

Features

- High-capacity precision balance, ideal for high volume or heavy samples to be weighed with a high degree of accuracy
- User guidance step by step on display by Yes/No dialogue
- Numerical subtraction of tare weight for known container weight. Useful for checking fill-levels
- Precise counting: The automatic reference weight optimisation of reference weight gradually improves the average piece weight value
- Freely programmable weighing unit, e.g. display direct in special units such as length of wire g/m, surface weight g/m², or else
- Protective working cover included with delivery

Technical data

- Large backlit LCD display, digit height 18 mm
- Weighing plate dimensions, stainless steel W×D×H
 - A 228×228×95 mm
 - B 308×318×75 mm, see larger picture
 - C 450×350×115 mm
- Dimensions of display device W×D×H 225×115×60 mm
- Cable length of display device approx.
 - A, B 2 m
 - C 0,6 m
- Permissible ambient temperature 10 °C/40 °C

Accessories

- Protective working cover over the display device, scope of delivery: 5 items, KERN DE-A12S05, € 40,-
- 1 Stand to elevate display device, height of stand approx. 480 mm for models with weighing plate size B, C, can be reordered, KERN DE-A10, € 100,-
- Mount to fasten the display device to the platform, for models with weighing plate size B, C, can be reordered, KERN DE-A11N, € 35,-
- Wall mount for display device, KERN DS-A02, € 30,-
- 2 Set for underfloor weighing, consists of platform, bow, hook, only for models with weighing plate B, KERN DS-A01, € 200,-
- Rechargeable battery pack external, operating time up to 30 h without backlight, charging time approx. 10 h, KERN KS-A01, € 160,-
- Internal rechargeable battery pack, operating time up to 30 h without backlight, charging time approx. 10 h, KERN KB-A01N, € 50,-
- Further details, plenty of further accessories and suitable printers see Accessories

STANDARD

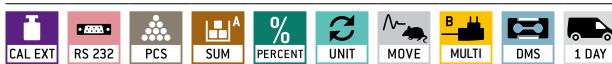

OPTION



Model	Weighing capacity [Max] kg	Readability [d] g	Smallest part weight [Normal] g/piece	Net weight approx. kg	Resolution Points	Weighing plate	Price excl. of VAT ex works €	Option	
								DAKKS	DAKKS Calibr. Certificate
KERN								DAKKS	€
DS 3K0.01S	3	0,01	0,1	4,2	300.000	A	640,-	963-127	78,-
DS 5K0.05S	5	0,05	0,5	4,2	100.000	A	560,-	963-127	78,-
DS 8K0.05	8	0,05	0,5	8	160.000	B	550,-	963-128	94,-
DS 10K0.1S	10	0,1	1	4,2	100.000	A	530,-	963-128	94,-
DS 16K0.1	16	0,1	1	9	160.000	B	550,-	963-128	94,-
DS 20K0.1	20	0,1	1	8	200.000	B	580,-	963-128	94,-
DS 30K0.1	30	0,1	1	8	300.000	B	610,-	963-128	94,-
DS 30K0.1L	30	0,1	1	10	300.000	C	720,-	963-128	94,-
DS 36K0.2	36	0,2	2	8	180.000	B	550,-	963-128	94,-
DS 36K0.2L	36	0,2	2	10	180.000	C	660,-	963-128	94,-
DS 60K0.2	60	0,2	2	10	300.000	C	740,-	963-129	116,-
DS 65K0.5	65	0,5	5	10	130.000	C	700,-	963-129	116,-
DS 100K0.5	100	0,5	5	10	200.000	C	740,-	963-129	116,-
DS 150K1	150	1	10	10	150.000	C	740,-	963-129	116,-



Platform scale with dust and spray protection IP65 and EC type approval [M]

Features

- Platform scale protected to IP65 with stainless steel display device, for industrial applications, hygienic and easy to clean
- 1** Platform: weighing plate stainless steel, painted steel base, silicone-coated aluminium load cell, protection against dust and water splashes IP65
- Display device: Stainless steel, protection against dust and water splashes IP65, flexible positioning, e.g. free-standing or mounted to the wall, for details see KERN KFE-TM
- Weighing with tolerance range (checkweighing): a visual and audible signal helps with portioning, dispensing or grading
- Hold function: When the weighing conditions are unstable, a stable weight is calculated determining an average value

- PRE-TARE function for manual subtraction of a known container weight, useful for checking fill-levels, (only for non-verified models)

Technical data

- Large backlit LCD display, digit height 22 mm
- Weighing plate dimensions, stainless steel W×D×H
 - A** 300×240×110 mm, see larger picture
 - B** 400×300×130 mm
 - C** 500×400×140 mm
 - D** 650×500×140 mm
- Dimensions of display device W×D×H 195×120×70 mm
- Cable length of display device approx. 3 m
- Internal rechargeable battery pack, operating time up to 35 h without backlight, charging time approx. 12 h
- Permissible ambient temperature -10 °C/40 °C

Accessories

- Stand to elevate display device, for models with weighing plate size
 - A-D**: Height of stand approx. 200 mm, Type **2**, KERN SFE-A01, € 55,-
 - B-D**: Height of stand approx. 400 mm, Type **2**, KERN SFE-A02, € 55,-
 - C-D**: Height of stand approx. 600 mm, Type **3**, KERN SFE-A03, € 65,-
- Tare pan made from stainless steel. Ideal for weighing loose small parts, fruit, vegetables, etc., KERN RFS-A02, € 55,-

STANDARD

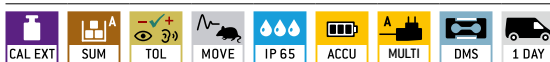

OPTION



FACTORY



Model	Weighing capacity [Max] kg	Readability [d] g	Verification value [e] g	Minimal load [Min] g	Net weight approx. kg	Weighing plate	Price excl. of VAT ex works €	Option			
								Verification		DAKKS Calibr. Certificate	
								M	€	DAKKS KERN	€
SFE 6K-3NM	6	2	2	40	6	A	370,-	965-228	70,-	963-128	94,-
SFE 10K-3NM	15	5	5	100	6	A	360,-	965-228	70,-	963-128	94,-
SFE 10K-3LNM	15	5	5	100	8	B	420,-	965-228	70,-	963-128	94,-
SFE 30K-2NM	30	10	10	200	6	A	360,-	965-228	70,-	963-128	94,-
SFE 60K-2NM	60	20	20	400	8	B	410,-	965-229	93,-	963-129	116,-
SFE 60K-2LNM	60	20	20	400	12	C	520,-	965-229	93,-	963-129	116,-
SFE 100K-2NM	150	50	50	1000	8	B	430,-	965-229	93,-	963-129	116,-
SFE 100K-2LNM	150	50	50	1000	12	C	520,-	965-229	93,-	963-129	116,-
SFE 100K-2XLNM	150	50	50	1000	20	D	660,-	965-229	93,-	963-129	116,-
SFE 300K-1LNM	300	100	100	2000	20	D	660,-	965-229	93,-	963-129	116,-

Note: For applications that require verification, please order verification at the same time, initial verification at a later date is not possible. Verification at the factory, we need to know the full address of the location of use.



10

Platform scale with stainless steel display device with IP68 rating, XL-display und EC type approval [M] – now also as high resolution version with high-resolution display



Piece-counting function



Durable stainless steel weighing plate



Stainless steel display device with IP68 protection, hygienic and easy to clean

Platform scale with stainless steel display device KERN IXS



Features

- Tough industry standard suitable for use in harsh industrial applications
- **1** Platform: weighing plate stainless steel, painted steel base, silicone-coated aluminium load cell, protection against dust and water splashes IP65, Substruction in wing design, extremely resistant to bending
- Superior display size: digit height 55 mm, bright backlight for easy reading of weighing results, even in poor lighting conditions
- Display device: Stainless steel, protection against dust and water splashes IP68, integrated power supply
- ESD drain to protect against electrostatic discharge e.g. for electrostatically-charged weighing objects or people who work with the scale
- Thanks to interfaces such as RS-232, RS-485 and Bluetooth (optional) the scale can easily be connected to existing networks and facilitates the data exchange between the scale and printer

Technical data

- Large backlit LCD display, digit height 55 mm
- Weighing plate dimensions, stainless steel W×D×H
 - A** 300×240×86 mm
 - B** 400×300×89 mm, see larger picture
 - C** 500×400×123 mm
 - D** 650×500×133,5 mm
- Dimensions of display device W×D×H 232×150×80 mm
- Cable length of display device approx. 2,5 m
- Permissible ambient temperature -10 °C/40 °C

Accessories

- **3** Stand to elevate display device
 - A-D** Height of stand approx. 50 mm, KERN IXS-A01, **€ 55,-**
 - A-D** Height of stand approx. 200 mm, KERN IXS-A02, **€ 70,-**
 - B-D** Height of stand approx. 400 mm, KERN IXS-A03, **€ 75,-**
 - C-D** Height of stand approx. 600 mm, KERN IXS-A04, **€ 85,-**

- Internal rechargeable battery pack, operating time up to 80 h without backlight, charging time approx. 12 h, KERN GAB-A04, **€ 40,-**
- Data interface RS-232, interface cable included, approx. 1,5 m, must be ordered at purchase, KERN KXS-A04, **€ 100,-**
- Data interface RS-485, must be ordered at purchase, KERN KXS-A01, **€ 145,-**
- **4** Bluetooth data interface for wireless data transfer to PC or tablets, must be ordered at purchase, not in combination with verification, KERN KXS-A02, **€ 170,-**
- Foot switch, must be ordered at purchase, KERN KXS-A03, **€ 130,-**
- Roller conveyor attachment, with smooth-running, hot-dip galvanised steel rollers with ball bearings, robust aluminium profile frame, KERN YRO-01, **€ 660,-**
- Further details, plenty of further accessories and suitable printers see *Accessories*

STANDARD

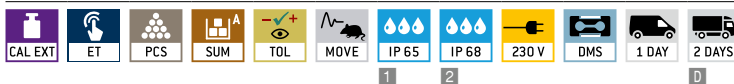

OPTION



FACTORY

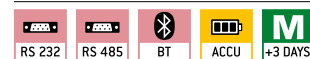

Model	Weighing range [Max] kg	Readability [d] g	Verification value [e] g	Minimal load [Min] g	Net weight approx. kg	Weighing plate	Price excl. of VAT ex works €	Option			
								Verification		DAkKS Calibr. Certificate	
KERN								M III KERN	€	DAkKS KERN	€
IXS 6K-4	6	0,2	-	-	6	A	520,-	-	-	963-128	94,-
IXS 10K-4	15	0,5	-	-	6	A	520,-	-	-	963-128	94,-
IXS 10K-4L	15	0,5	-	-	11	B	590,-	-	-	963-128	94,-
IXS 30K-3	30	1	-	-	11	B	590,-	-	-	963-128	94,-
IXS 30K-3L	30	1	-	-	22	C	720,-	-	-	963-128	94,-
IXS 60K-3	60	2	-	-	11	B	590,-	-	-	963-129	116,-
IXS 60K-3L	60	2	-	-	22	C	720,-	-	-	963-129	116,-
IXS 100K-3	150	5	-	-	22	C	720,-	-	-	963-129	116,-
IXS 100K-3L	150	5	-	-	36	D	790,-	-	-	963-129	116,-
IXS 300K-2	300	10	-	-	36	D	790,-	-	-	963-129	116,-
Dual-range balance switches automatically to the next largest weighing capacity [Max] and readability [d]											
IXS 6K-3M	3 6	1 2	1 2	20 40	6	A	520,-	965-228	70,-	963-128	94,-
IXS 10K-3M	6 15	2 5	2 5	40 100	6	A	530,-	965-228	70,-	963-128	94,-
IXS 10K-3LM	6 15	2 5	2 5	40 100	11	B	590,-	965-228	70,-	963-128	94,-
IXS 30K-2M	15 30	5 10	5 10	100 200	11	B	590,-	965-228	70,-	963-128	94,-
IXS 30K-2LM	15 30	5 10	5 10	100 200	22	C	720,-	965-228	70,-	963-128	94,-
IXS 60K-2M	30 60	10 20	10 20	200 400	11	B	590,-	965-229	93,-	963-129	116,-
IXS 60K-2LM	30 60	10 20	10 20	200 400	22	C	720,-	965-229	93,-	963-129	116,-
IXS 100K-2M	60 150	20 50	20 50	400 1000	22	C	720,-	965-229	93,-	963-129	116,-
IXS 100K-2LM	60 150	20 50	20 50	400 1000	36	D	800,-	965-229	93,-	963-129	116,-
IXS 300K-2M	150 300	50 100	50 100	1000 2000	36	D	800,-	965-229	93,-	963-129	116,-

Note: For applications that require verification, please order verification at the same time, initial verification at a later date is not possible. Verification at the factory, we need to know the full address of the location of use.

* Either RS-232 or RS-485 can be installed and used

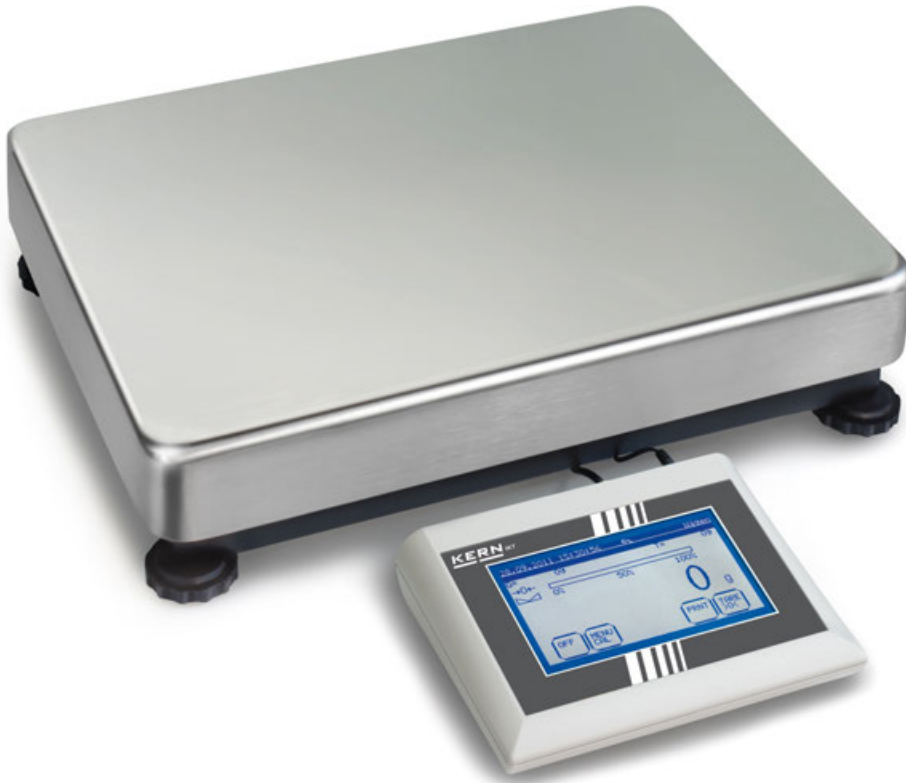

Alibi memory

- Ring memory for up to 49,152 measuring results (744 measuring results per day!)
- Saved measuring results cannot be changed or cleared. If the maximum memory capacity is reached, then the oldest value will be overwritten
- In addition to the measuring result, the date, time, tare value, a sequential number and the serial number of the balance are also saved.
- Saved measuring results can be searched and recalled easily
- The alibi memory can also be used for applications which do not require verification
- Complies with WELMEC 2.5



10

Touchscreen platform scale with enormous range of functions



Easy input of text and values
Using large keypad, e.g. up to 80 item descriptions, user name, packaging weights for tare containers etc.



80 memories for each mode
e.g. for Checkweighing, PRE-TARE, reference weight, target value when dispensing, item descriptions, user name, weights for tare containers, etc. Easy to enter using the large-scale keypad

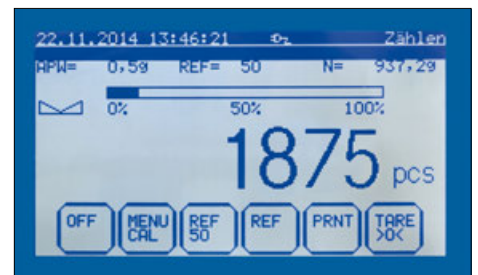

Professional counting function
All relevant counting information at a glance, such as, e.g., reference weight, reference quantity, total count, total weight, tare container weight, available weighing capacity and much more

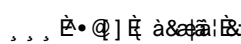

Industrial platform scale KERN IKT

Features

- Convenient recipe weighing: 99 In recipes with 10 components each can be stored in plain text. There is a function to adjust the other components if the initial weight was too high. The actual values and the desired values well as the proportionate percentages can be printed afterwards.
- Multiplier function: recipes with the ingredient weights recorded as percentage values can easily be replicated by entering a new target weight. The ideal solution for the preparation of larger containers, bulk packs etc.
- Rapid function for shortened stabilisation time with reduced readability
- Control outputs (optocoupler, digital I/O) to connect relays, signal lamps, valves etc. (35 V/80 mA)

Technical data

- Large backlit LCD touch display, digit height 18 mm, screen diagonal 5,8" (127×74mm)
- Weighing plate dimensions, stainless steel W×D×H
 - A 228×228×95 mm
 - B 315×308×75 mm
 - C 450×350×115 mm, see larger picture
 - D 650×500×142 mm
- Dimensions of display device W×D×H 315×305×75 mm
- Cable length of display device approx., for models with weighing plate size
 - A 1 m
 - B, D 2 m
 - C 0,6 m
- Permissible ambient temperature 10 °C/40 °C

Accessories

- Rechargeable battery pack external, operating time up to 20 h without backlight, charging time approx. 10 h, KERN KS-A01, **€ 160,-**
- Signal lamp for visual support of weighing with tolerance range, KERN IKT-A04, **€ 260,-**
- RS-232/Ethernet adapter for connection to an IP-based Ethernet network, KERN YKI-01, **€ 290,-**
- RS-232/USB adapter, to connect peripheral devices with USB connection, SAUTER AFH 12, **€ 85,-**
- **I** Set for underfloor weighing, consists of platform, bow, hook, only for models with weighing plate **B**, KERN DS-A01, **€ 200,-**
- Stand to elevate display device, for models with weighing plate size **B**, **C**, height of stand approx. 480 mm, KERN IKT-A06, **€ 105,-**
- Wall mount for display device, KERN IKT-A03, **€ 35,-**
- Suitable printers see Accessories

Modes

- ① Weighing
- ② Counting
- ③ Dispensing
- ④ Recipe weighing
- ⑤ Checkweighing
- ⑥ Totalising with daily total
- ⑦ Percentage determination
- ⑧ Animal weighing
- ⑨ Surface weight
- ⑩ Density determination, only with **B**
- ⑪ Rapid function

Functions

- Capacity display with ①, ②, ⑤-⑦, ⑨-⑩
- Dispensing aid (-/+), with ③, ④
- Net/gross display, permanent, with ①, ③-⑤, ⑧-⑪
- Variable reference quantity, with ②
- Automatic reference optimisation, with ②
- PRE-TARE numerical or from the memory unit, with ①-⑦, ⑪
- Entering of item or batch description, operator etc., with ①-⑦, ⑪
- Freely programmable weighing unit, e.g. display direct in special units such as length of thread g/m, grammage g/m², or similar, with ⑨
- Date/time, with ①-⑪
- Statistical function, with ①
- GLP printout, with ①-⑪
- Individual formatting of up to 16 printer forms, recipes, operating mode master data in MS Excel, import via RS-232, for examples, see the internet, with ①-⑪

STANDARD



OPTION

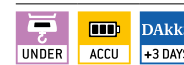

Model	Weighing capacity [Max] kg	Readability [d] g	Smallest part weight [Normal] g/piece	Net weight approx. kg	Weighing plate	Price excl. of VAT ex works €	Option	
							DAkKS Calibr. Certificate DAkKS KERN	€
IKT 6K0.1	6	0,1	1	8	B	830,-	963-128	94,-
IKT 12K0.2	12	0,2	2	8	B	830,-	963-128	94,-
IKT 30K0.5	30	0,5	5	8	B	830,-	963-128	94,-
IKT 60K1L	60	1	10	10	C	1050,-	963-129	116,-
IKT 150K2XL	150	2	20	20	D	1200,-	963-129	116,-
IKT 300K5XL	300	5	50	20	D	1200,-	963-129	116,-
IKT 3K0.01S	3	0,01	0,1	6	A	920,-	963-127	78,-
IKT 8K0.05	8	0,05	0,5	8	B	850,-	963-128	94,-
IKT 16K0.1	16	0,1	1	8	B	850,-	963-128	94,-
IKT 30K0.1	30	0,1	1	8	B	850,-	963-128	94,-
IKT 30K0.1L	30	0,1	1	10	C	1150,-	963-128	94,-
IKT 36K0.2	36	0,2	2	8	B	850,-	963-128	94,-
IKT 36K0.2L	36	0,2	2	10	C	1050,-	963-128	94,-
IKT 60K0.2L	60	0,2	2	10	C	1120,-	963-129	116,-
IKT 65K0.5L	65	0,5	5	10	C	1050,-	963-129	116,-
IKT 100K0.5L	100	0,5	5	10	C	1150,-	963-129	116,-
IKT 150K1L	150	1	10	10	C	1150,-	963-129	116,-

I ONLY WHILE STOCKS LAST

11

Floor scales/Pallet scales/Drive-through scales

From Goods Inwards through to production and on to dispatch – our modern, powerful floor scales can be used everywhere and used intuitively. Through many clever functions, they will help your company to carry out processes effectively and economically in a way that saves resources, while meeting high requirements.

In our floor scales product category, we offer our customers a carefully coordinated product range in the weighing range from 300 to 6,000 kg. Choose between affordable entry level models, practical built-in solutions or Premium products made from stainless steel and verified. All floor scales really stand out because of their durable industrial quality as well as reliable protection against dust and water splashes.

Industrial scales for large loads

When weighing large containers and heavy goods, scales must overcome different challenges. As well as correspondingly large weighing ranges, a high level of stability and sturdiness is necessary, in order to withstand the maximum loads acting on the weighing plate. Our floor scales are perfectly suited for this task, for example through generously sized struts and material thicknesses, mobile stored adjustable feet for the protection of the load cells, IP67 protection against dust and water splashes or a convenient disconnect device between the display device and platform. The latter means that you can install a verified scale in a packing and dispatch bench or a pit frame for barrier-free access at a later date. Large LCD displays make it easier to read the display even if the angle of view is not ideal. We also have pallet scales, weighing beams and drive-through scales available for versatile use.

Our recommendation: High-resolution KERN BIC floor scale with 2 x 3,000 [d] at the best price-to-performance ratio.

Easy integration through digital interfaces

Thanks to interfaces such as RS 232 and Bluetooth, the scale can easily be connected to existing networks. Data exchange between scale and PC or printer is easy and reliable. The standardised KCP interface (Kern Communication Protocol) takes over the searching and remote control of the scale using external control devices or computers. KCP enables you to recall and control the relevant parameters and device functions and is also compatible with the MT-SICS protocol in most cases.

Our recommendation: High-resolution dual-range KERN UID pallet scale with EC type approval [M] and various data interfaces

The KERN calibration and verification service

In order to fulfil quality requirements in accordance with DIN EN ISO 9000ff and other standards, we can offer our customers DAKkS calibration. Calibration ensures correct, usable weighing results and makes the floor scale into a reliable measuring and testing instrument. When calibrating, deviations in the display will be identified and documented. The main points to remember are: DAKkS calibration is always sensible, when checking equipment is to be used in a QM process. While calibration is not legally regulated, verification is mandatory in different applications for example:

- In commercial trade when the price of a commodity is determined by weighing
- In the production of pre-packaged goods
- In the pharmaceutical industry
- For official purposes.

Our recommendation: BID floor scale with EC type approval [M] and the best price-to-performance ratio – now also as a high-resolution dual-range balance

Individual solutions for maximum efficiency

The weighing ranges of bench counting scales are often not sufficient to count large quantities, units or items on pallets. This is where high-performance counting systems come into their own, as these combine a high-precision reference scale with a high-capacity bulk scale, such as for example a floor scale, pallet scale or drive-through scale.

If you have special requirements, you can also configure your ideal scale easily and quickly so that it meets your needs. We will put your weighing combination together for you, using the components you have selected and including verification. Please contact your personal customer advisor for further information!

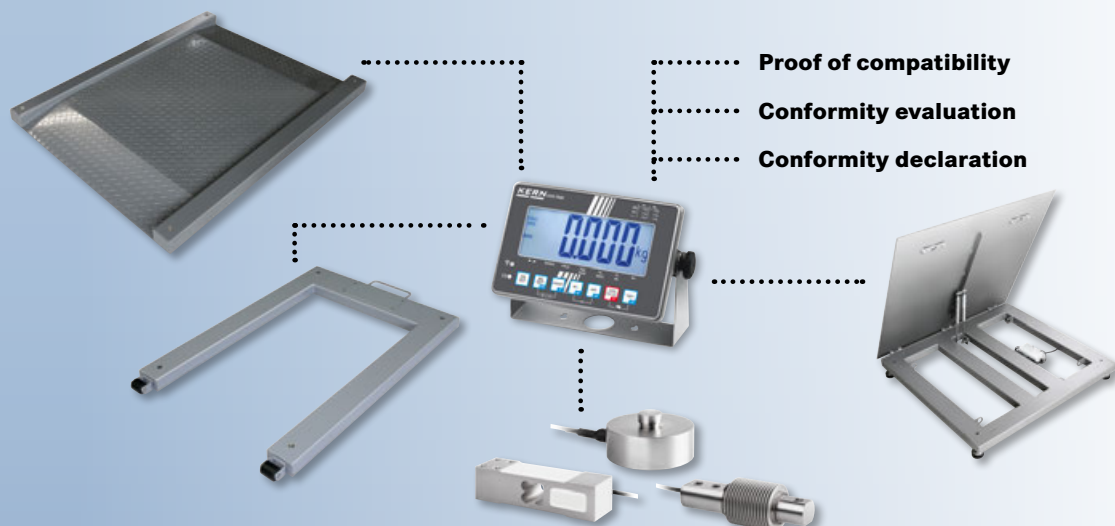

Quick-Finder Floor scales/Pallet scales/Drive-through scales

Readability [d] g	Weighing capacity [Max] kg	Weighing plate W×D×H mm	Model KERN	Price excl. of VAT ex works €	Page												
						For an explanation on the pictos, see front flap											
100	300	1000×1000×80	NIB 300K-1	640,-	123	2		●						●			
100 200	300 600	1000×1000×108	BIC 600K-1S	750,-	112	2		●						●			
100 200	300 600	1200×1500×108	BIC 600K-1	990,-	112	2		●						●			
100 200	300 600	1000×1000×108	BID 600K-1DSM	1090,-	113	2	○	●	●		●	●	●	●			
100 200	300 600	1200×1500×108	BID 600K-1DM	1320,-	113	2	○	●	●		●	●	●	●			
100 200	300 600	1195×840×110	UID 600K-1DM	960,-	120	2	○	●	●		●	●	●	●	○		
200	600	1000×1000×108	BID 600K-1SM	1020,-	113	2	○	●	●		●	●	●	●			
200	600	1200×1500×108	BID 600K-1M	1250,-	113	2	○	●	●		●	●	●	●			
200	600	1000×1000×90	BFN 600K-1SM	2550,-	117	2	○	●	○		●	●	●	●	●		
200	600	800×120×100	UFA 600K-1S	880,-	118	2		●	●		●	●	●	●	○		
200	600	1000×1000×85	BFB 600K-1SNM	1100,-	116	2	○	●	●		●	●	●	●	○		
200	600	1500×1250×85	BFB 600K-1NM	1490,-	116	2	○	●	●		●	●	●	●	○		
200	600	1195×840×110	UIB 600K-1	760,-	119	2		●					●	●			
200	600	1195×840×110	UID 600K-1M	920,-	120	2	○	●	●		●	●	●	●	○		
200	600	1190×840×90	UFB 600K200M	950,-	121	2	○	●	●		●	●	●	●	○		
200	600	1600×1200×80	NFB 600K200M	1450,-	124	2	○	●	●	○	●	●	●	●	○		
200	600	1800×1400×80	NFB 600K200LM	1650,-	124	2	○	●	●	○	●	●	●	●	○		
200	600	1600×1200×80	NFN 600K-1M	2650,-	125	2	○	●	○		●	●	●	●	●		
200	600	1360×840×90	UFN 600K200IPM	1290,-	122	2	○	●	○		●	●	●	●	●		
200	600	1000×1000×80	NIB 600K-2	640,-	123	2		●					●	●			
200 500	600 1500	1000×1000×108	BIC 1T-4S	750,-	112	2		●						●			
200 500	600 1500	1200×1500×108	BIC 1T-4	990,-	112	2		●						●			
200 500	600 1500	1000×1000×108	BID 1T-4DSM	1090,-	113	2	○	●	●		●	●	●	●			
200 500	600 1500	1200×1500×108	BID 1T-4DM	1350,-	113	2	○	●	●		●	●	●	●			
200 500	600 1500	1190×840×110	UID 1500K-1DM	960,-	120	2	○	●	●		●	●	●	●	○		
500	1500	1000×1000×108	BID 1T-4SM	1020,-	113	2	○	●	●		●	●	●	●			
500	1500	1200×1000×108	BID 1T-4EM	1120,-	113	2	○	●	●		●	●	●	●			
500	1500	1200×1500×108	BID 1T-4M	1280,-	113	2	○	●	●		●	●	●	●			
500	1500	1500×1500×108	BID 1T-4LM	1490,-	113	2	○	●	●		●	●	●	●			
500	1500	1495×1245×95	BFN 1.5T0.5M	3250,-	117	2	○	●	○		●	●	●	●	●		
500	1500	1000×1000×90	BFN 1T-4SM	2550,-	117	2	○	●	○		●	●	●	●	●		
500	1500	1200×120×100	UFA 1.5T0.5	870,-	118	2		●	●		●	●	●	●	○		
500	1500	1000×1000×100	BFB 1T-4SNM	1100,-	116	2	○	●	●		●	●	●	●	○		
500	1500	1500×1250×90	BFB 1T-4NM	1490,-	116	2	○	●	●		●	●	●	●	○		
500	1500	1195×840×110	UIB 1.5T-4	760,-	119	2		●					●	●			
500	1500	1190×840×110	UID 1500K-1M	920,-	120	2	○	●	●		●	●	●	●	○		
500	1500	1190×840×90	UFB 1.5T0.5M	950,-	121	2	○	●	●		●	●	●	●	○		
500	1500	1600×1200×80	NFB 1.5T0.5M	1370,-	124	2	○	●	●	○	●	●	●	●	○		
500	1500	1800×1400×80	NFB 1.5T0.5LM	1650,-	124	2	○	●	●	○	●	●	●	●	○		
500	1500	1600×1200×80	NFN 1.5T-4M	2850,-	125	2	○	●	○		●	●	●	●	●		
500	1500	1360×840×90	UFN 1.5T0.5IPM	1590,-	122	2	○	●	○		●	●	●	●	●		
500 1000	1500 3000	1200×1500×108	BIC 3T-3	990,-	112	2		●						●			
500 1000	1500 3000	1500×1500×108	BIC 3T-3L	1200,-	112	2		●						●			
500 1000	1500 3000	1200×1500×108	BID 3T-3DM	1360,-	113	2	○	●	●		●	●	●	●			
500 1000	1500 3000	1500×1500×108	BID 3T-3DLM	1520,-	113	2	○	●	●		●	●	●	●			
500 1000	1500 3000	1190×840×110	UID 3000K-ODM	960,-	120	2	○	●	●		●	●	●	●	○		
1000	3000	1200×1500×108	BID 3T-3M	1290,-	113	2	○	●	●		●	●	●	●			
1000	3000	1500×1500×108	BID 3T-3LM	1470,-	113	2	○	●	●		●	●	●	●			
1000	3000	1495×1245×95	BFN 3T-3M	3250,-	117	2	○	●	○		●	●	●	●	●		
1000	3000	1200×120×100	UFA 3T1	890,-	118	2		●	●		●	●	●	●	○		
1000	3000	2000×160×100	UFA 3T-3L	1050,-	118	2		●	●		●	●	●	●	○		
1000	3000	1500×1250×85	BFB 3T-3NM	1490,-	116	2	○	●	●		●	●	●	●	○		
1000	3000	1500×1500×80	BFB 3T1LM	1700,-	116	2	○	●	●		●	●	●	●	○		
1000	3000	1195×840×110	UIB 3T-3	760,-	119	2		●					●	●			
1000	3000	1195×840×110	UID 3000K-OM	920,-	120	2	○	●	●		●	●	●	●	○		
2000	6000	1200×160×100	UFA 6T-3	1190,-	118	2		●	●		●	●	●	●	○		
2000	6000	2000×160×100	UFA 6T-3L	1490,-	118	2		●	●		●	●	●	●	○		
2000	6000	1500×1500×130	BFB 6T-3M	1980,-	116	2	○	●	●		●	●	●	●	○		

News 2021

● = standard ○ = option

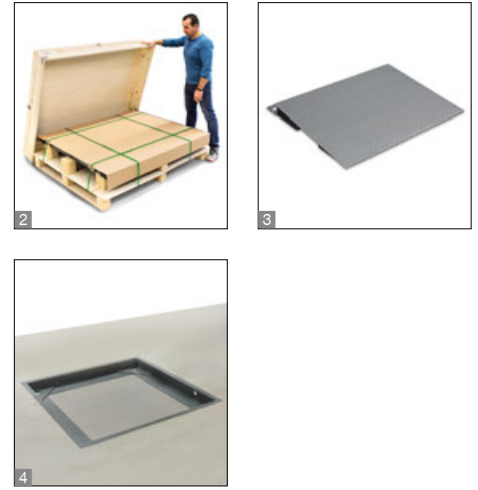
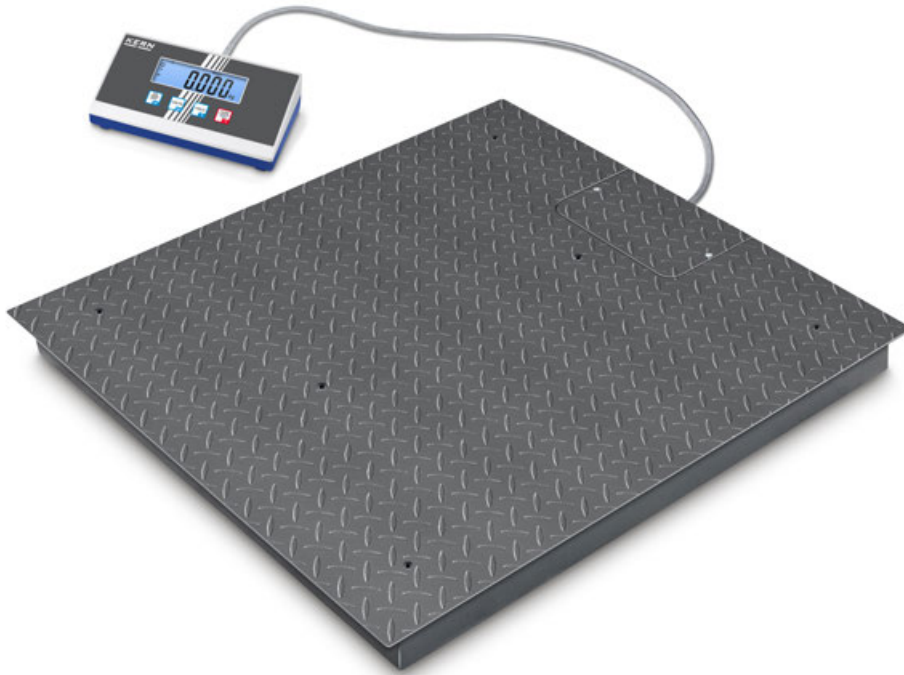

High-resolution floor scale with 2×3000 [d] and the best price-to performance ratio

Features

- **1** Weighing bridge: out of anti-slip corrugated steel, 4 silicone-coated steel load cells, dust and spray protection IP67
- Welded platform with screw holes to lift the scale for easy cleaning
- Easy levelling of the weighing bridge as well as access to the junction box from above
- Simple and convenient 4-key operation
- Wall mount for display device, standard
- A clever plug-in connector means that you can easily separate the display device and the platform, e.g. for installing the balance in a packing and dispatch bench, pit frame etc. at a later date
- **2** Did you know? Our floor scales are delivered in a robust wooden box. This protects the high-quality weighing technology from environmental influences and stresses during transportation. KERN – always one step ahead

Technical data

- Large LCD display, digit height 25 mm
- Weighing plate dimensions W×D×H
 - A** 1000×1000×108 mm
 - B** 1200×1500×108 mm
 - C** 1500×1500×108 mm
- Dimensions of display device W×D×H 235×114×51 mm
- Optional battery operation, 4×1.5 V AA not included in scope of delivery, operating time up to 60 h
- Cable length of display device approx. 5 m
- Permissible ambient temperature -10 °C/40 °C

Accessories

- Protective working cover, scope of delivery: 5 items, KERN EOB-A02S05, **€ 40,-**
- Pair of base plates to fix the weighing bridge to the floor, KERN BIC-A07, **€ 40,-**
- **2** Ascending ramp, steel, powder coated, for models with weighing plate size
 - A** 1000×1000×108 mm, KERN BIC-A01, **€ 350,-**
 - B** 1200×1000×108 mm, KERN BIC-A02, **€ 380,-**
 - C** 1500×1000×108 mm, KERN BIC-A03, **€ 465,-**
- **3** Stable pit frame, steel, for models with weighing plate size
 - A** 1088×1088×110 mm, KERN BIC-A04, **€ 300,-**
 - B** 1288×1588×110 mm, KERN BIC-A05, **€ 335,-**
 - C** 1588×1588×110 mm, KERN BIC-A06, **€ 355,-**

11

STANDARD

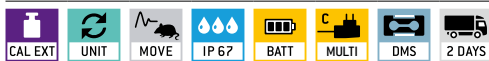

OPTION



I Shipment via freight forwarder. Please ask for dimensions, gross weight, shipping costs

Model	Weighing capacity [Max] kg	Readability [d] kg	Net weight approx. kg	Weighing plate	Price excl. of VAT ex works €	Option	
						DAKKS KERN	DAKKS Calibr. Certificate €
Dual-range balance switches automatically to the next largest weighing capacity [Max] and readability [d]							
BIC 600K-1S	300 600	0,1 0,2	70	A	750,-	963-130	165,-
BIC 600K-1	300 600	0,1 0,2	150	B	990,-	963-130	165,-
BIC 1T-4S	600 1500	0,2 0,5	150	A	750,-	963-130	165,-
BIC 1T-4	600 1500	0,2 0,5	70	B	990,-	963-130	165,-
BIC 3T-3	1500 3000	0,5 1	150	B	990,-	963-132	440,-
BIC 3T-3L	1500 3000	0,5 1	150	C	1200,-	963-132	440,-

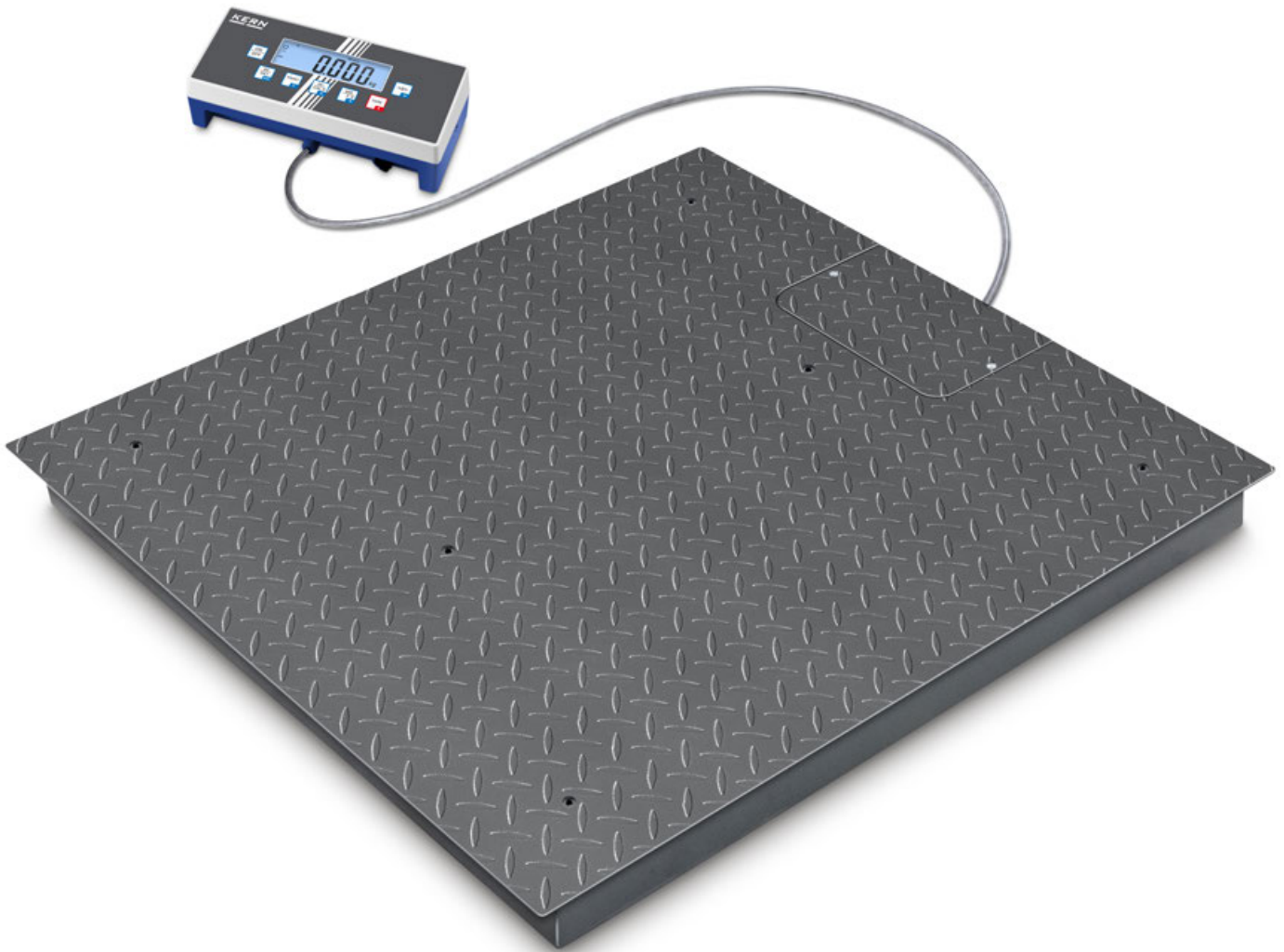

Floor scale with EC type approval [M]* and the best price-to-performance ratio – now also as high-resolution dual-range balance



Did you know?
Our floor scales are delivered in a robust wooden box. This protects the high-quality weighing technology from environmental influences and stresses during transportation. KERN – always one step ahead



3 Access ramp incl. pair of base plates to facilitate access of e.g. wire cage trolleys, shelf trolleys, container trolleys, storage trolleys, sack trucks, transpallets, mobile containers, containers refuse etc.



4 Verification plug, for verified balances this enables you to separate the display device and platform without affecting the verification

Features

- Dual-range floor scales, ideal, high maximum loads need to be weighed, but in the lower load range you still need high resolution. This means that two scales can be replaced with one – which saves space and money!
- BID 1T-4EM: Compact special size, especially for weighing europallets
- **1** Weighing bridge: out of anti-slip corrugated steel, 4 silicone-coated steel load cells, dust and spray protection IP67
- Easy levelling of the weighing bridge as well as access to the junction box from above
- **2** Display device: for details see KERN KIB-TM
- Totalising of weights and piece counts
- Thanks to interfaces such as RS-232 or USB, WiFi, Bluetooth, Ethernet (optional), the scale can easily be connected to existing networks. Data exchange between the scale, PC or printer
- Searching and remote control of the balance using external control devices or computers with the KERN Communication Protocol (KCP). KCP is a standardised interface command structure for KERN balances and other instruments which allows you to recall and manage all relevant parameters and device functions. You can therefore simply connect KERN devices with KCP to computers, industrial control systems and other digital systems. In a large number of cases the KCP is compatible with the MT-SICS protocol.

Technical data

- Large LCD display, digit height 25 mm
- Weighing plate dimensions W×D×H
 - A** 1000×1000×108 mm
 - B** 1200×1000×108 mm
 - C** 1200×1500×108 mm
 - D** 1500×1500×108 mm
- Dimensions of display device W×D×H 268×115×80 mm
- Cable length of display device approx. 5 m
- Permissible ambient temperature -10 °C/40 °C

Accessories

- Protective working cover, scope of delivery: 5 items, KERN EOC-A01S05, **€ 40,-**
- Pair of base plates to fix the weighing bridge to the floor, KERN BIC-A07, **€ 40,-**
- Ascending ramp, steel, powder coated, for models with weighing plate size
 - A, B** KERN BIC-A01, **€ 350,-**
 - C** KERN BIC-A02, **€ 380,-**
 - D** KERN BIC-A03, **€ 465,-**
- Stable pit frame, Steel, powder-coated, to install the weighing bridge so you can drive straight on, for models with weighing plate size
 - A** KERN BIC-A04, **€ 300,-**
 - B** KERN BIC-A08, **€ 330,-**
 - C** KERN BIC-A05, **€ 335,-**
 - D** KERN BIC-A06, **€ 355,-**
- Benchtop stand incl. wall mount for display device, KERN EOC-A04, **€ 30,-**
- Internal rechargeable battery pack, operating time up to 43 h without backlight, charging time approx. 3 h, KERN KFB-A01, **€ 35,-**
- USB data interface, for transferring weighing to the PC, printer etc., KERN KIB-A03, **€ 120,-**
- Bluetooth data interface for wireless data transfer to PC or tablets, must be ordered at purchase, not possible in combination with verification, KERN KIB-A04, **€ 110,-**

- WiFi interface for wireless connection of the balance to networks and WiFi capable devices, such as tablets, laptops or smartphones, continuous data transfer, must be ordered at purchase, KERN KIB-A10, **€ 120,-**
- Ethernet data interface, to connect an IP-based Ethernet network, continuous data transfer, must be ordered at purchase, KERN KIB-A02, **€ 150,-**
- Signal lamp, including interface, for visual support of weighing with tolerance range, must be ordered at purchase, KERN KIB-A06, **€ 370,-**
- Alibi memory, including USB interface for exporting weighing results to external data storage media, such as, for example, USB sticks, hard drives, etc. Not in combination with verification, KERN KIB-A01, **€ 150,-**
- Verification plug, for verified balances this enables you to separate the display device and platform without affecting the verification, e.g. for installing the scale in a packing and dispatch table, pit frame etc. at a later date. Please order this at the same time as you purchase your scale, KERN KIB-A12, **€ 150,-**

Note:

For verified scales the weighing bridge must be fixed to the floor. Optionally, with an access ramp, a footplate pair or a pit frame

In addition to the RS-232 data interface, which is integrated as standard, only one other data interface can be installed and operated

1 Shipment via freight forwarder. Please ask for dimensions, gross weight, shipping costs

STANDARD: CAL EXT, ET, RS 232, KCP, GLP, PCS, SUM, PERCENT, TOL, MOVE, IP 65, IP 67, MULTI, DMS, 2 DAYS

OPTION: DAKKS +3 DAYS

FACTORY: ALIBI, USB, BT 4.0, WIFI, SWITCH, LAN, M +3 DAYS

Model	Weighing capacity [Max] kg	Readability = Verification value [d] = [e] kg	Minimal load [Min] kg	Net weight approx. kg	Weighing plate	Price excl. of VAT ex works €	Option			
							Verification		DAKKS Calibr. Certificate	
							M	€	DAKKS KERN	€
BID 600K-1SM	600	0,2	4	70	A	1020,-	965-230	132,-	963-130	165,-
BID 600K-1M	600	0,2	4	150	C	1250,-	965-230	132,-	963-130	165,-
BID 1T-4SM	1500	0,5	10	70	A	1020,-	965-230	132,-	963-130	165,-
BID 1T-4M	1500	0,5	10	150	C	1280,-	965-230	132,-	963-130	165,-
BID 1T-4EM	1500	0,5	10	85	B	1120,-	965-230	132,-	963-130	165,-
BID 1T-4LM	1500	0,5	10	160	D	1490,-	965-230	132,-	963-130	165,-
BID 3T-3M	3000	1	20	150	C	1290,-	965-232	200,-	963-132	440,-
BID 3T-3LM	3000	1	20	160	D	1470,-	965-232	200,-	963-132	440,-
Dual-range balance switches automatically to the next largest weighing capacity [Max] and readability [d]										
BID 600K-1DSM	300 600	0,1 0,2	4	70	A	1090,-	965-230	132,-	963-130	165,-
BID 600K-1DM	300 600	0,1 0,2	4	150	C	1320,-	965-230	132,-	963-130	165,-
BID 1T-4DSM	600 1500	0,2 0,5	10	70	A	1090,-	965-230	132,-	963-130	165,-
BID 1T-4DM	600 1500	0,2 0,5	10	150	C	1350,-	965-230	132,-	963-130	165,-
BID 3T-3DM	1500 3000	0,5 1	20	150	C	1360,-	965-232	200,-	963-132	440,-
BID 3T-3DLM	1500 3000	0,5 1	20	160	D	1520,-	965-232	200,-	963-132	440,-

Note: For applications that require verification, please order verification at the same time, initial verification at a later date is not possible. Verification at the factory, we need to know the full address of the location of use.

* Verification not in combination with KERN KIB-A02, KIB-A03, KIB-A04, KIB-A10

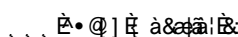

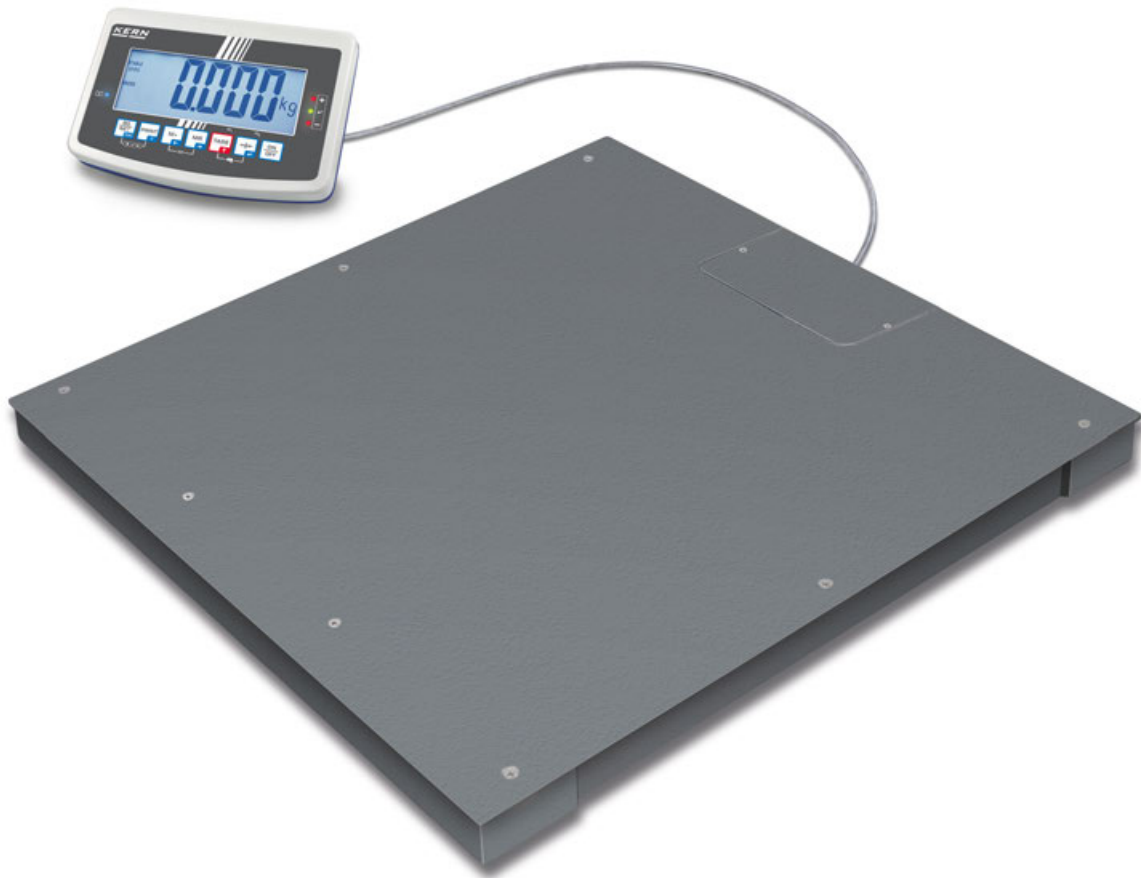

Weighing bridge with screwed-on weighing plate (IP67) and XXL display device, with EC type approval [M]



Weighing plate can be unscrewed
The weighing plate can be conveniently unscrewed for maintenance or cleaning purposes (weighing plate size **A**, **B**)

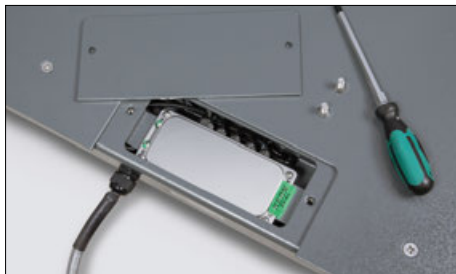

Easy levelling of the weighing bridge as well as access to the junction box from above



Did you know? Our floor scales are delivered in a robust wooden box. This protects the high-quality weighing technology from environmental influences and stresses during transportation. KERN – always one step ahead

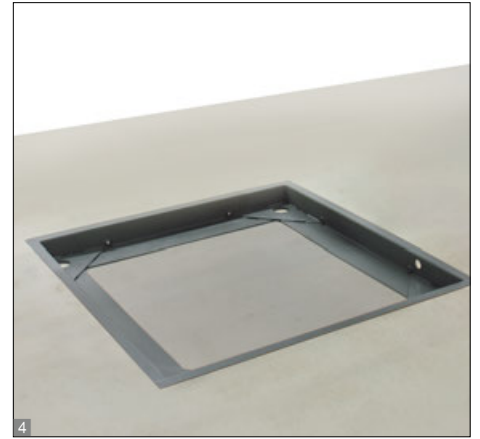

Features

- Weighing plate **A**, **B** screwed on from the top, so it easy to remove, hygienic and easy to clean
- **1** Weighing bridge: steel, powder coated, weighing plate size **C**, **D** corrugated steel plate, welded, 4 silicone-coated steel load cells, dust and spray protection IP67
- Display device: for details see KERN KFB-TM
- Benchtop stand incl. wall mount for display device as standard
- Totalising of weights and piece counts
- Protective working cover included with delivery

Technical data

- Large backlit LCD display, digit height 52 mm
- Weighing plate dimensions W×D×H
 - A** 1000×1000×85 mm
 - B** 1500×1250×85 mm
 - C** 1500×1500×80 mm
 - D** 1500×1500×130 mm
- Dimensions of display device W×D×H 250×160×58 mm
- Cable length of display device approx. 5 m
- Permissible ambient temperature -10 °C/40 °C

Accessories

- Protective working cover, scope of delivery: 5 items, KERN KFB-A02S05, **€ 40,-**
- **2** Stand to elevate display device Column height approx. 800 mm, KERN BFS-A07, **€ 120,-**
- Pair of base plates to fix the weighing bridge to the floor, for models with weighing plate size **A**, **B**, **C** KERN BFS-A06N, **€ 70,-**, **D** KERN BFS-A10, **€ 60,-**
- **3** Ascending ramp, Steel, lacquered, not included, for models with weighing plate size **A** KERN BFS-A10N, **€ 80,-**, **B** KERN BFS-A02N, **€ 350,-**, **C** KERN BFS-A09, **€ 410,-**, **D** KERN BFS-A11, **€ 500,-**
- **4** Stable pit frame, steel, for models with weighing plate size **A** KERN BFS-A03N, **€ 310,-**, **B** KERN BFS-A04N, **€ 370,-**, **C** KERN BFS-A08, **€ 365,-**
- Internal rechargeable battery pack, operating time up to 35 h without backlight, charging time approx. 10 h, must be ordered at purchase, KERN KFB-A01, **€ 35,-**
- Bluetooth data interface for wireless data transfer to PC or tablets, must be ordered at purchase, not in combination with verification, not possible in combination with RS 232 data interface, KERN KFB-A03, **€ 130,-**

- Analogue module, must be ordered at purchase, not possible in combination with signal lamp 0-10 V: KERN KFB-A04, **€ 95,-**, 4-20 mA: KERN KFB-A05, **€ 95,-**
- Signal lamp for visual support of weighing with tolerance range, not possible in combination with analogue module, KERN CFS-A03, **€ 250,-**
- Large display with superior display size, KERN YKD-A02, **€ 220,-**
- Cable with special length 15 m, between display device and platform, for verified models which must be ordered at the time of purchase, KERN BFB-A03, **€ 160,-**
- Further details, plenty of further accessories and suitable printers see *Accessories*

Note: For verified scales the weighing bridge must be fixed to the floor. Optionally, with an access ramp, a footplate pair or a pit frame

1 Shipment via freight forwarder. Please ask for dimensions, gross weight, shipping costs

STANDARD



OPTION



FACTORY



Model	Weighing capacity [Max] kg	Readability = Verification value [d] = [e] kg	Minimal load [Min] kg	Net weight approx. kg	Weighing plate	Price excl. of VAT ex works €	Option			
							Verification		DAkkS Calibr. Certificate	
							M	€	DAkkS	€
BFB 600K-1SNM	600	0,2	4	105	A	1 100,-	965-230	132,-	963-130	165,-
BFB 600K-1NM	600	0,2	4	135	B	1 490,-	965-230	132,-	963-130	165,-
BFB 1T-4SNM	1500	0,5	10	105	A	1 100,-	965-230	132,-	963-130	165,-
BFB 1T-4NM	1500	0,5	10	105	B	1 490,-	965-230	132,-	963-130	165,-
BFB 3T-3NM	3000	1	20	135	B	1 490,-	965-232	200,-	963-132	440,-
BFB 3T1LM	3000	1	20	155	C	1 700,-	965-232	200,-	963-132	440,-
BFB 6T-3M	6000	2	40	210	D	1 980,-	965-232	200,-	963-132	440,-

Note: For applications that require verification, please order verification at the same time, initial verification at a later date is not possible. Verification at the factory, we need to know the full address of the location of use.

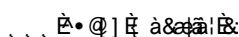

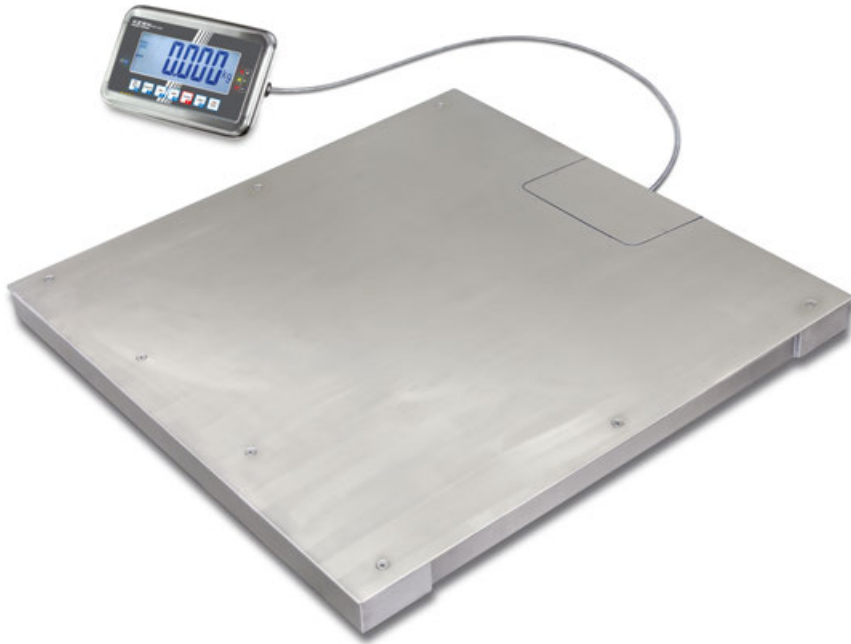

Stainless steel weighing bridge with screwed-on weighing plate (IP68) and stainless steel display device (IP65), with EC type approval [M]

Features

- Tough industry standard suitable for use in harsh industrial applications
- Weighing plate screwed on from the top with stainless steel screws, so it's easy to remove, hygienic and easy to clean
- **1** Weighing bridge: stainless steel, extremely resistant to bending due to material thickness, 4 welded stainless steel load cells, dust and spray protection IP68. Weighing bridge can also be delivered as component without the display device, for details see KERN KFD-V40.
- Your support in a HACCP-compliant quality system
- Easy levelling of the weighing bridge as well as access to the junction box from above
- **2** Display device: Stainless steel, protection against dust and water splashes IP65, for industrial applications, hygienic and easy to clean, integrated power supply. The display device can also be delivered as a component without the weighing bridge, for details see KERN KFN-TM
- Benchtop stand incl. wall mount for display device as standard

- Thanks to the RS 232, RS 485 and Bluetooth (optional) interfaces, the balance can easily be connected to existing networks. Data exchange between the balance and PC or printer is also made easier
- Totalising of weights and piece counts
- Internal rechargeable battery pack included with delivery
- Did you know? Our floor scales are delivered in a robust wooden box. This protects the high-quality weighing technology from environmental influences and stresses during transportation. KERN – always one step ahead

Technical data

- Large backlit LCD display, digit height 52 mm
- Dimensions of display device WxDxH 266x165x96 mm
- Cable length of display device approx. 5 m
- Weighing plate dimensions WxDxH **A** 1000x1000x90 mm, **B** 1500x1250x95 mm
- Permissible ambient temperature -10 °C/40 °C

Accessories

- **3** Stand to elevate display device, height of stand approx. 800 mm, KERN YKP-02, **€ 190,-**
- Pair of base plates to fix the weighing bridge to the floor, KERN BFN-A03, **€ 60,-**
- **4** Ascending ramp, stainless steel, not included, for models with weighing plate size **A** KERN BFN-A05, **€ 1090,-**
B KERN BFN-A01, **€ 1120,-**
- **6** Stable pit frame, Stainless Steel, for models with weighing plate size **A** KERN BFN-A06, **€ 730,-**
B KERN BFN-A02, **€ 850,-**
- Internal rechargeable battery pack, operating time up to 35 h without backlight, charging time approx. 12 h, KERN GAB-A04, **€ 40,-**
- RS 232 data interface including interface cable 1,5 m, must be ordered at purchase, KERN KFN-A01, **€ 95,-**
- Cable with special length 15 m, between display device and platform, for verified models which must be ordered at the time of purchase, KERN BFB-A03, **€ 160,-**
- Further details, plenty of further accessories and suitable printers see Accessories

Note: For verified scales the weighing bridge must be fixed to the floor. Optionally, with an access ramp, a footplate pair or a pit frame

1 Shipment via freight forwarder. Please ask for dimensions, gross weight, shipping costs

STANDARD



OPTION



FACTORY

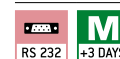

Model	Weighing capacity [Max] kg	Readability = Verification value [d] = [e] kg	Minimal load [Min] kg	Net weight approx. kg	Weighing plate	Price excl. of VAT ex works €	Option			
							Verification		DAkkS Calibr. Certificate	
KERN							M KERN	€	DAkkS KERN	€
BFN 600K-1SM	600	0,2	4	100	A	2550,-	965-230	132,-	963-130	165,-
BFN 1T-4SM	1500	0,5	10	100	A	2550,-	965-230	132,-	963-130	165,-
BFN 1.5T0.5M	1500	0,5	10	145	B	3250,-	965-230	132,-	963-130	165,-
BFN 3T-3M	3000	1	20	150	B	3250,-	On request		963-132	440,-

Note: For applications that require verification, please order verification at the same time, initial verification at a later date is not possible. Verification at the factory, we need to know the full address of the location of use.



Highly versatile weighing beams (IP67) for large loads to 6 t

Features

- Flexible solution for weighing large, bulky or long items
- High mobility: thanks to rechargeable battery operation (optional), compact, lightweight construction, it is suitable for the use in several locations
- **1** Weighing beams: steel, painted, 4 silicone-coated aluminium load cells, protection against dust and water splashes IP67, weighing beams can also be delivered as components without the display device, for details see KERN KFA-V20
- Sturdy handles for transporting the weighing beams
- **2** KERN UFA-L: Each weighing beam has a roller and handle for easy transport of the scale
- Display device: for details see KERN KFB-TM
- Benchtop stand incl. wall mount for display device as standard
- Totalising of weights and piece counts
- Protective working cover included with delivery

- KERN UFA-S, new model with short weighing beams, ideal for weighing compact items or animals in transport boxes
- Did you know? Our floor scales are delivered in a robust wooden box. This protects the high-quality weighing technology from environmental influences and stresses during transportation. KERN – always one step ahead

Technical data

- Large backlit LCD display, digit height 52 mm
- Dimensions of display device W×D×H 250×160×65 mm
- Cable length of display device approx. 5 m
- Cable length weighing beams approx. 5 m
- Permissible ambient temperature -10 °C/40 °C

Accessories

- Protective working cover, scope of delivery: 5 items, KERN KFB-A02S05, € 40,-
- **3** Stand to elevate display device Column height approx. 800 mm, KERN BFS-A07, € 120,-
- Internal rechargeable battery pack, operating time up to 35 h without backlight, charging time approx. 10 h, KERN KFB-A01, € 35,-
- Bluetooth data interface for wireless data transfer to PC or tablets, must be ordered at purchase, not in combination with verification, KERN KFB-A03, € 130,-
- Analogue module, must be ordered at purchase, not possible in combination with signal lamp
0-10 V: KERN KFB-A04, € 95,-
4-20 mA: KERN KFB-A05, € 95,-
- **4** Signal lamp for visual support of weighing with tolerance range, not possible in combination with analogue module, KERN CFS-A03, € 250,-
- **5** Large display with superior display size, KERN YKD-A02, € 220,-
- Y-cable for parallel connection of two terminal devices to the RS-232 interface on the scale, e.g. signal lamp and printer, KERN CFS-A04, € 35,-
- Cable with special length 15 m, between display device and platform, for verified models which must be ordered at the time of purchase, KERN BFB-A03, € 160,-
- Further details, plenty of further accessories and suitable printers see Accessories

STANDARD



OPTION



FACTORY



Model	Weighing capacity [Max] kg	Readability [d] kg	Net weight approx. kg	Dimensions Weighing beam W×D×H mm	Price excl. of VAT ex works €	Option	
						DAKKS KERN	Calibr. Certificate €
UFA 600K-1S	600	0,2	36	800×120×100	880,-	963-130	165,-
UFA 1.5T0.5	1500	0,5	38	1200×120×100	870,-	963-130	165,-
UFA 3T1	3000	1	38	1200×120×100	890,-	963-132	440,-
UFA 3T-3L	3000	1	60	2000×160×100	1050,-	963-132	440,-
UFA 6T-3	6000	2	85	1200×160×100	1190,-	963-132	440,-
UFA 6T-3L	6000	2	135	2000×160×100	1490,-	963-132	440,-

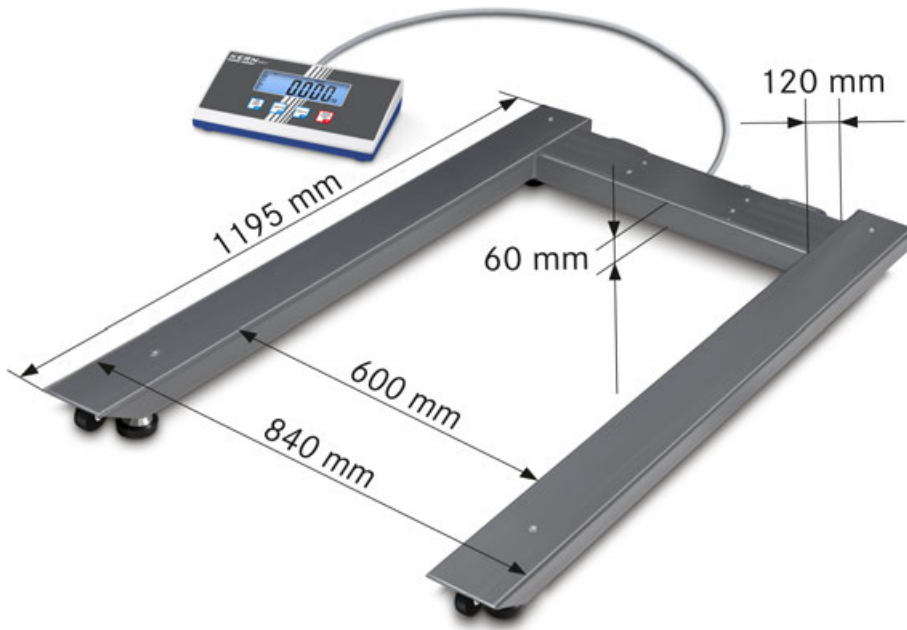

Pallet scale with steel load support (IP67) and the best price-to-performance ratio

Features

- High mobility: thanks to battery operation, compact, lightweight construction, it is suitable for the use in several locations
- **1** Load support: steel, powder coated, 4 silicone-coated aluminium load cells, protection against dust and water splashes IP67
- **2** The scale can be easily transported using rollers and a handle and does not require much storage space
- Totalising of weights and piece counts
- Protective working cover included with delivery
- **3** Did you know? Our floor scales are delivered in a robust wooden box. This protects the high-quality weighing technology from environmental influences and stresses during transportation. KERN – always one step ahead

Technical data

- Large LCD display, digit height 25 mm
- Dimensions of display device W×D×H 235×115×52 mm
- Cable length of display device approx. 5 m
- Optional battery operation, 4×1.5 V AA not included in scope of delivery, operating time up to 60 h
- Net weight approx. 55 kg
- Permissible ambient temperature -10 °C/40 °C

Accessories

- Protective working cover over the display device, scope of delivery: 5 items, KERN EOB-A04BS05, **€ 40,-**
- Stand to elevate display device, height of stand approx. 1000 mm, can be reordered, KERN EOB-A02B, **€ 80,-**

1 Shipment via freight forwarder. Please ask for dimensions, gross weight, shipping costs

STANDARD

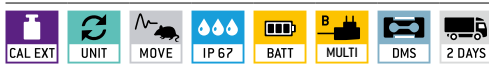

OPTION



Model	Weighing capacity [Max] kg	Readability [d] kg	Net weight approx. kg	Price excl. of VAT ex works €	Option	
					DAKKS KERN	DAKKS Calibr. Certificate €
KERN						
UIB 600K-1	600	0,2	55	760,-	963-130	165,-
UIB 1.5T-4	1500	0,5	55	760,-	963-130	165,-
UIB 3T-3	3000	1	55	760,-	963-132	440,-

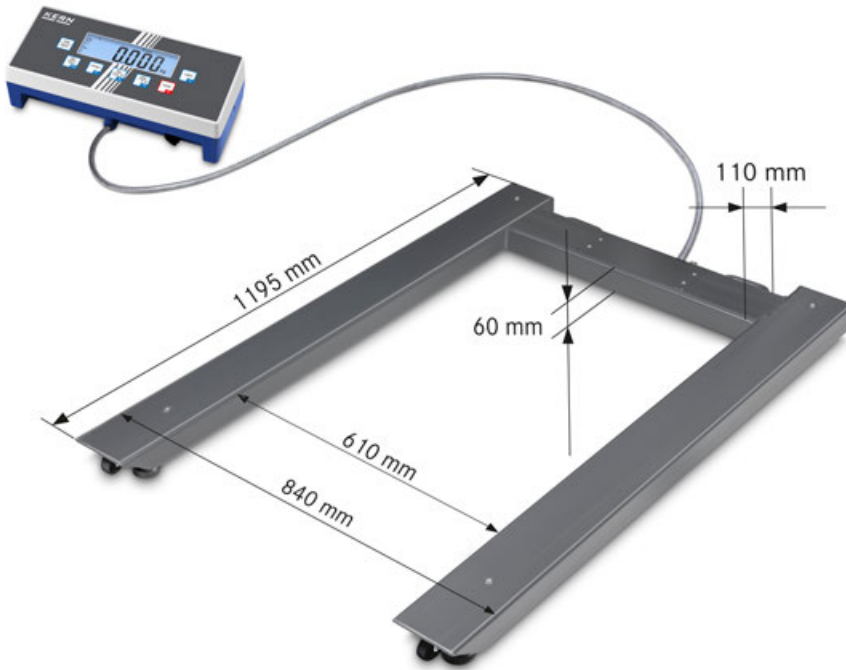

High-resolution dual-range pallet scale with EC type approval [M] and a wide range of interfaces

Features

- Dual-range pallet scale! Ideal, when high maximum loads need to be weighed, but in the lower load range you still need high resolution. This means that two scales can be replaced with one – which saves space and money!
- High mobility thanks to battery operation for display device and platform
- **M** Load support: steel, powder coated, 4 silicone-coated steel load cells, protection against dust and water splashes IP67
- The scale can be easily transported using rollers and a handle and does not require much storage space
- Totalising of weights and piece counts
- Searching and remote control of the balance using external control devices or computers with the KERN Communication Protocol (KCP). KCP is a standardised interface command structure for KERN balances and other instruments which allows you to recall and

manage all relevant parameters and device functions. You can therefore simply connect KERN devices with KCP to computers, industrial control systems and other digital systems. In a large number of cases the KCP is compatible with the MT-SICS protocol.

- Due to interfaces such as RS-232 or USB, WiFi, Bluetooth, Ethernet (optional), the scale can easily be connected to existing networks. Data exchange between the scale, PC or printer
- Protective working cover included with delivery

Technical data

- Large LCD display, digit height 25 mm
- Dimensions of display device W×D×H 268×115×80 mm
- Cable length of display device approx. 5 m
- Net weight 44 kg
- Permissible ambient temperature -10 °C/40 °C

Accessories

- Protective working cover, scope of delivery: 5 items, KERN EOC-A01S05, € 40,-
- Stand to elevate display device, height of stand approx. 800 mm, KERN BFS-A07, € 120,-
- Internal rechargeable battery pack, operating time up to 43 h without backlight, charging time approx. 3 h, KERN KFB-A01, € 35,-
- Bluetooth data interface for wireless data transfer to PC or tablets, must be ordered at purchase, not possible in combination with verification, KERN KIB-A04, € 110,-
- WiFi interface for wireless connection of the balance to networks and WiFi capable devices, such as tablets, laptops or smartphones, continuous data transfer, must be ordered at purchase, KERN KIB-A10, € 120,-
- Ethernet data interface, to connect an IP-based Ethernet network, continuous data transfer, must be ordered at purchase, KERN KIB-A02, € 150,-
- Signal lamp, including interface, for visual support of weighing with tolerance range, must be ordered at purchase, KERN KIB-A06, € 370,-
- Alibi memory, including USB interface for exporting weighing results to external data storage media, such as, for example, USB sticks, hard drives, etc., KERN KIB-A01, € 150,-
- Verification plug, for verified balances this enables you to separate the display device and platform without affecting the verification, e.g. for installing the scale in a packing and dispatch table, pit frame etc. at a later date. Please order this at the same time as you purchase your scale, KERN KIB-A12, € 150,-

Note: In addition to the RS-232 interface, which is integrated as standard, only one other interface can be installed and operated

M Shipment via freight forwarder. Please ask for dimensions, gross weight, shipping costs

STANDARD										OPTION			FACTORY										

Model	Weighing capacity [Max] kg	Readability = Verification value [d] = [e] kg	Price excl. of VAT ex works €	Option			
				Verification		DAkKS Calibr. Certificate	
KERN					€	DAkKS	€
UID 600K-1M	600	0,2	920,-	965-230	132,-	963-130	165,-
UID 1500K-1M	1500	0,5	920,-	965-230	132,-	963-130	165,-
UID 3000K-0M	3000	1	920,-	965-232	200,-	963-132	440,-
Dual-range balance switches automatically to the next largest weighing capacity [Max] and readability [d]							
UID 600K-1DM	300 600	0,1 0,2	960,-	965-230	132,-	963-130	165,-
UID 1500K-1DM	600 1500	0,2 0,5	960,-	965-230	132,-	963-130	165,-
UID 3000K-0DM	1500 3000	0,5 1	960,-	965-232	200,-	963-132	440,-

Note: For applications that require verification, please order verification at the same time, initial verification at a later date is not possible. Verification at the factory, we need to know the full address of the location of use.

* Verification not in combination with KERN KIB-A02, KIB-A03, KIB-A04, KIB-A10

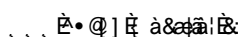

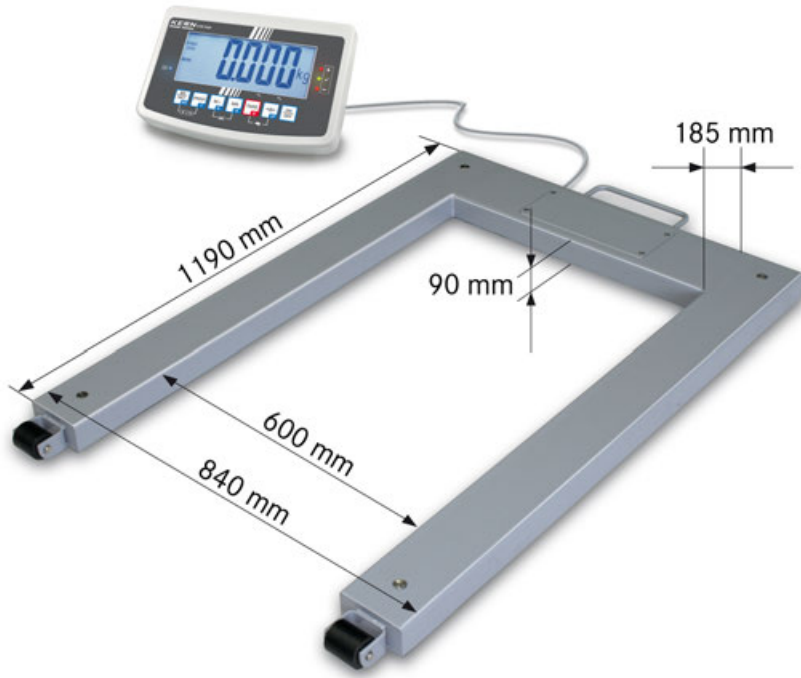

Pallet scale with steel load support (IP67) and EC type approval [M]

Features

- High mobility: thanks to rechargeable battery operation (optional), compact, lightweight construction, it is suitable for the use in several locations
- **1** Load support: steel, powder coated, 4 silicone-coated aluminium load cells, protection against dust and water splashes IP67, Weighing bridge can also be delivered as component without the display device, for details see KERN KFU-V20
- Two wheels for easy transportation of the scale
- Weighing with tolerance range (checkweighing): A visual and audible signal assists the rapid checking of items on pallets
- Totalising of weights and piece counts
- Protective working cover included with delivery
- **2** Did you know? Our floor scales are delivered in a robust wooden box. This protects the high-quality weighing technology from environmental influences and stresses during transportation. KERN – always one step ahead

Technical data

- Large backlit LCD display, digit height 52 mm
- Dimensions of display device WxDxH 250x160x58 mm
- Cable length of display device approx. 5 m
- Net weight approx. 55 kg
- Permissible ambient temperature -10 °C/40 °C

Accessories

- Protective working cover, scope of delivery: 5 items, KERN KFB-A02S05, **€ 40,-**
- **3** Stand to elevate display device Column height approx. 800 mm, KERN BFS-A07, **€ 120,-**
- Internal rechargeable battery pack, operating time up to 35 h without backlight, charging time approx. 12 h, KERN KFB-A01, **€ 35,-**
- Bluetooth data interface for wireless data transfer to PC or tablets, must be ordered at purchase, not in combination with verification, KERN KFB-A03, **€ 130,-**
- Analogue module, must be ordered at purchase, not possible in combination with signal lamp 0-10 V, KERN KFB-A04, **€ 95,-** 4-20 mA, KERN KFB-A05, **€ 95,-**

- **4** Signal lamp for visual support of weighing with tolerance range, not possible in combination with analogue module, KERN CFS-A03, **€ 250,-**
- **5** Large display with superior display size, KERN YKD-A02, **€ 220,-**
- Y-cable for parallel connection of two terminal devices to the RS-232 interface on the scale, e.g. signal lamp and printer, KERN CFS-A04, **€ 35,-**
- Cable with special length 15 m, between display device and platform, for verified models which must be ordered at the time of purchase, KERN BFB-A03, **€ 160,-**
- Further details, plenty of further accessories and suitable printers see *Accessories*

1 Shipment via freight forwarder. Please ask for dimensions, gross weight, shipping costs

STANDARD



OPTION



FACTORY



Model	Weighing capacity [Max] kg	Readability [d] kg	Minimal load [Min] kg	Price excl. of VAT ex works €	Option			
					Verification		DAkkS Calibr. Certificate	
KERN							DAkkS KERN	
UFB 600K200M	600	0,2	4	950,-	965-230	132,-	963-130	165,-
UFB 1.5T0.5M	1500	0,5	10	950,-	965-230	132,-	963-130	165,-

Note: For applications that require verification, please order verification at the same time, initial verification at a later date is not possible. Verification at the factory, we need to know the full address of the location of use.

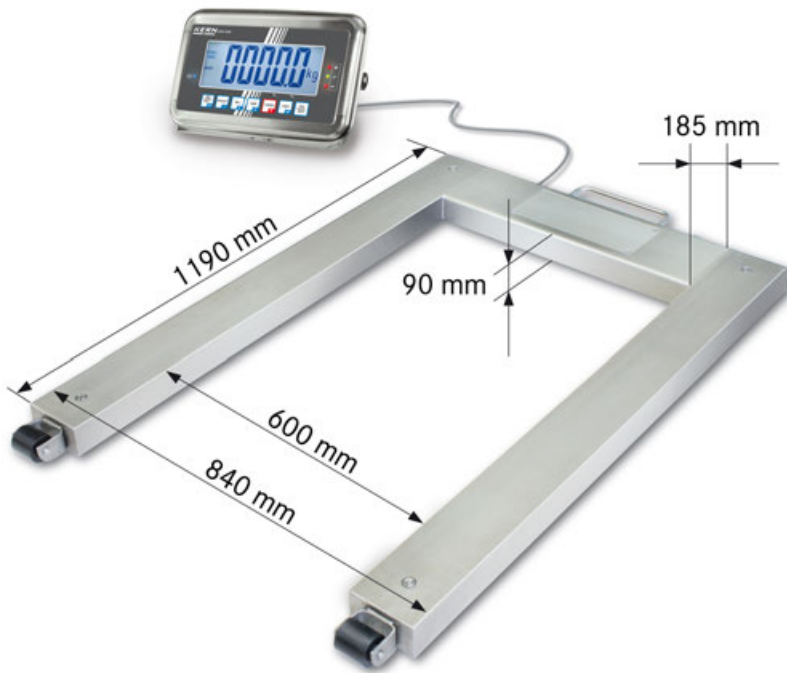

Pallet scale with stainless steel load support (IP67) and stainless steel display device (IP65), with EC type approval [M]

Features

- High mobility: thanks to rechargeable battery operation, compact, lightweight construction, it is suitable for the use in several locations (production, warehouse, dispatch department etc.)
- **1** Load support: stainless steel, extremely resistant to bending due to material thickness, 4 silicone-coated stainless steel load cells, protection against dust and water splashes IP67, weighing bridge can also be delivered as component without the display device, for details see KERN KFU-V30
- Your support in a HACCP-compliant quality system
- Suitable for the ever-increasing hygienic requirements in the food industry
- **2** Display device: for details see KERN KFN-TM
- The scale can be easily transported using rollers and a handle and does not require much storage space
- Hold function: When the weighing conditions are unstable, a stable weight is calculated determining an average value

- Weighing with tolerance range (checkweighing): A visual and audible signal assists the rapid checking of items on pallets
- Totalising of weights
- Internal rechargeable battery pack included with delivery
- **3** Did you know? Our floor scales are delivered in a robust wooden box. This protects the high-quality weighing technology from environmental influences and stresses during transportation. KERN – always one step ahead

Technical data

- Large backlit LCD display, digit height 52 mm
- Dimensions of display device WxDxH 266x165x96 mm
- Cable length of display device approx. 5 m
- Net weight approx. 50 kg
- Permissible ambient temperature -10 °C/40 °C

Accessories

- **4** Stand to elevate display device, height of stand approx. 800 mm, KERN BFN-A04, € 285,-
- Internal rechargeable battery pack, operating time up to 35 h without backlight, charging time approx. 10 h, KERN GAB-A04, € 40,-
- RS 232 data interface including interface cable, KERN KFN-A01, € 95,-
- **5** Large display with superior display size, only in combination with data interface KFN-A01, KERN YKD-A02, € 220,-
- Cable with special length 15 m, between display device and platform, for verified models which must be ordered at the time of purchase, KERN BFB-A03, € 160,-
- Further details, plenty of further accessories and suitable printers see Accessories

Limited tare range with verifiable models 1/6 from [Max]

1 Shipment via freight forwarder. Please ask for dimensions, gross weight, shipping costs

STANDARD										OPTION			FACTORY		

Model	Weighing capacity [Max] kg	Readability = Verification value [d] = [e] kg	Minimal load [Min] kg	Price excl. of VAT ex works €	Option			
					Verification		DAkkS Calibr. Certificate	
KERN						€	DAkkS	€
UFN 600K200IPM	600	0,2	4	1290,-	KERN	965-230 132,-	KERN	963-130 165,-
UFN 1.5T0.5IPM	1500	0,5	10	1590,-	KERN	965-230 132,-	KERN	963-130 165,-

Note: For applications that require verification, please order verification at the same time, initial verification at a later date is not possible. Verification at the factory, we need to know the full address of the location of use.

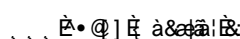

NEW



Compact, robust drive-through scale – particularly mobile thanks to its carrying handle, rollers and lightweight construction

Features

- Drive-through scale for rapid weighing of e.g. wire cage trolleys, shelf trolleys, container trolleys, storage trolleys, sack trucks, transpallets, mobile containers, containers refuse etc.
- Low platform height and integrated access ramps on both sides facilitate access. No need for pit frame installation – which saves money
- **1** Weighing bridge: Steel, powder coated, 4 silicon-coated aluminium load cells with protection against dust and water splashes to IP67
- **1** Level indicator for accurate levelling of the balance as standard
- **2** The scale can be easily transported using rollers and a handle and does not require much storage space
- Wall mount for the display device, as standard, only for models without a column
- Protective working cover included with delivery
- **3** Did you know? Our floor scales are delivered in a robust wooden box. This protects the high-quality weighing technology from environmental influences and stresses during transportation. KERN – always one step ahead

Technical data

- LCD display, digit height 25 mm
- Overall dimensions W×D×H 1066×1000×80 mm
- Platform height in the drive-through area: 40 mm
- Dimensions weighing surface 800×800 mm
- Dimensions of display device W×D×H 235×114×51 mm
- Cable length of display device approx. 5 m
- Optional battery operation, 4×1.5 V AA not included in scope of delivery, operating time up to 60 h
- External mains adapter standard
- Permissible ambient temperature -10 °C/40 °C

Accessories

- Protective working cover, scope of delivery: 5 items, KERN EOB-A02S05, € 40,-
- Pair of base plates to fix the weighing bridge to the floor, KERN BIC-A07, € 40,-

STANDARD

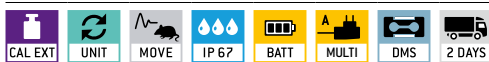

OPTION



Model	Weighing capacity [Max] kg	Readability [d] kg	Net weight approx. kg	Price excl. of VAT ex works €	Option	
					DAKKS KERN	DAKKS Calibr. Certificate €
NIB 300K-1	300	0,1	60	640,-	963-129	116,-
NIB 600K-2	600	0,2	60	640,-	963-130	165,-

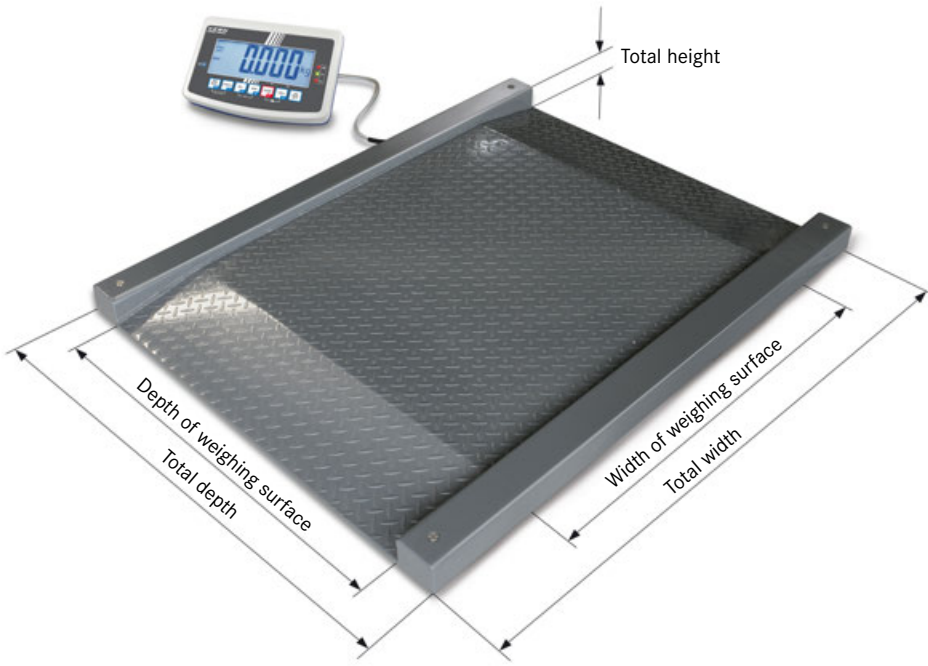

Drive-through scale (IP67) with XXL display device and EC type approval [M]

Features

- Drive-through scale for rapid weighing of e.g. wire cage trolleys, shelf trolleys, container trolleys, storage trolleys, sack trucks, transpallets, mobile containers, containers refuse etc.
- Low platform height and integrated access ramps on both sides facilitate access. No need for pit frame installation – which saves money
- **I** Weighing bridge: out of anti-slip corrugated steel, 4 silicone-coated steel load cells, dust and spray protection IP67
- Display device: for details see KERN KFB-TM
- Protective working cover included with delivery
- Did you know? Our floor scales are delivered in a robust wooden box. This protects the high-quality weighing technology from environmental influences and stresses during transportation. KERN – always one step ahead

Technical data

- Large backlit LCD display, digit height 52 mm
- Overall dimensions W×D×H
 - A** 1600×1200×80 mm
 - B** 1800×1400×80 mm
- Platform height in the drive-through area: 80 mm
- Dimensions of weighing surface
 - A** W×D 1000×1000 mm
 - B** W×D 1200×1200 mm
- Dimensions of display device W×D×H 250×160×65 mm
- Cable length of display device approx. 5 m
- Permissible ambient temperature -10 °C/40 °C

Accessories

- Protective working cover, scope of delivery: 5 items, KERN KFB-A02S05, **€ 40,-**
- **B** Stand to elevate display device Column height approx. 800 mm, KERN BFS-A07, **€ 120,-**

- Pair of base plates to fix the weighing bridge to the floor, KERN BFS-A06, **€ 70,-**
- Internal rechargeable battery pack, operating time up to 35 h without backlight, charging time approx. 10 h, KERN KFB-A01, **€ 35,-**
- Bluetooth data interface for wireless data transfer to PC or tablets, must be ordered at purchase, not in combination with verification, KERN KFB-A03, **€ 130,-**
- Analogue module, must be ordered at purchase, not possible in combination with signal lamp 0-10 V: KERN KFB-A04, **€ 95,-**
4-20 mA: KERN KFB-A05, **€ 95,-**
- **4** Signal lamp for visual support of weighing with tolerance range, not possible in combination with analogue module, KERN CFS-A03, **€ 250,-**
- **5** Large display with superior display size, KERN YKD-A02, **€ 220,-**
- Y-cable for parallel connection of two terminal devices to the RS-232 interface on the scale, e.g. signal lamp and printer, KERN CFS-A04, **€ 35,-**
- Cable with special length 15 m, between display device and platform, for verified models which must be ordered at the time of purchase, KERN BFB-A03, **€ 160,-**
- Further details, plenty of further accessories and suitable printers see *Accessories*

Note: For verified scales the weighing bridge must be fixed to the floor. Optionally, with an access ramp, a footplate pair or a pit frame

I Shipment via freight forwarder. Please ask for dimensions, gross weight, shipping costs

STANDARD



OPTION



FACTORY



Model	Weighing capacity [Max] kg	Readability = Verification value [d] = [e] kg	Minimal load [Min] kg	Net weight approx. kg	Weighing plate	Price excl. of VAT ex works €	Option			
							Verification		DAkKS Calibr. Certificate	
KERN							M III KERN	€	DAkKS KERN	€
NFB 600K200M	600	0,2	4	130	A	1450,-	965-230	132,-	963-130	165,-
NFB 600K200LM	600	0,2	4	165	B	1650,-	965-230	132,-	963-130	165,-
NFB 1.5T0.5M	1500	0,5	10	130	A	1370,-	965-230	132,-	963-130	165,-
NFB 1.5T0.5LM	1500	0,5	10	155	B	1650,-	965-230	132,-	963-130	165,-

Note: For applications that require verification, please order verification at the same time, initial verification at a later date is not possible. Verification at the factory, we need to know the full address of the location of use.



Stainless steel drive-through scale (IP68) with stainless steel display device (IP65), with EC type approval [M]

Features

- Robust stainless steel drive-through scale for rapid weighing of e.g. laundry carts, container trolleys, roller containers, etc. Ideal for hospital laundry services, goods inwards, hospital kitchens, etc.
- Low platform height and integrated access ramps on both sides facilitate access. No need for pit frame installation – which saves money
- Ideal for the increased hygienic requirements in the food, pharmaceutical and chemical industries
- **1** Weighing bridge: stainless steel, extremely resistant to bending due to material thickness, 4 welded stainless steel load cells, dust and spray protection IP68. Weighing bridge can also be delivered as component without the display device, for details see KERN KFD-V40
- Your support in a HACCP-compliant quality system
- **2** Display device: for details see KERN KFN-TM
- Totalising of weights and piece counts
- Internal rechargeable battery pack included with delivery

- **3** Did you know? Our floor scales are delivered in a robust wooden box. This protects the high-quality weighing technology from environmental influences and stresses during transportation. KERN – always one step ahead

Technical data

- Large backlit LCD display, digit height 52 mm
- Overall dimensions WxDxH 1600x1200x80 mm
- Platform height in the drive-through area: 80 mm
- Dimensions weighing surface WxD 1000x1000 mm
- Dimensions of display device WxDxH 266x165x96 mm
- Cable length of display device approx. 5 m
- Permissible ambient temperature -10 °C/40 °C

Accessories

- **4** Stand to elevate display device, height of stand approx. 800 mm, KERN BFN-A04, € 285,-
- Pair of base plates to fix the weighing bridge to the floor, KERN BFN-A03, € 60,-
- Internal rechargeable battery pack, operating time up to 35 h without backlight, charging time approx. 12 h, KERN GAB-A04, € 40,-
- Data interface RS-232, interface cable included, approx. 1,5 m, must be ordered at purchase, KERN KFN-A01, € 95,-
- **5** Large display with superior display size, only in combination with data interface KFN-A01, KERN YKD-A02, € 220,-
- Cable with special length 15 m, between display device and platform, for verified models which must be ordered at the time of purchase, KERN BFB-A03, € 160,-
- Further details, plenty of further accessories and suitable printers see Accessories

Note: For verified scales the weighing bridge must be fixed to the floor. Optionally, with an access ramp, a footplate pair or a pit frame

1 Shipment via freight forwarder. Please ask for dimensions, gross weight, shipping costs

STANDARD



OPTION



FACTORY

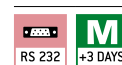

Model	Weighing capacity [Max] kg	Readability = Verification value [d] = [e] kg	Minimal load [Min] kg	Net weight approx. kg	Price excl. of VAT ex works €	Option			
						Verification		DAkkS Calibr. Certificate	
KERN							€	DAkkS	€
NFN 600K-1M	600	0,2	4	130	2650,-	KERN	132,-	KERN	165,-
NFN 1.5T-4M	1500	0,5	10	125	2850,-	KERN	132,-	KERN	165,-

Note: For applications that require verification, please order verification at the same time, initial verification at a later date is not possible. Verification at the factory, we need to know the full address of the location of use.

↓ Price reduction

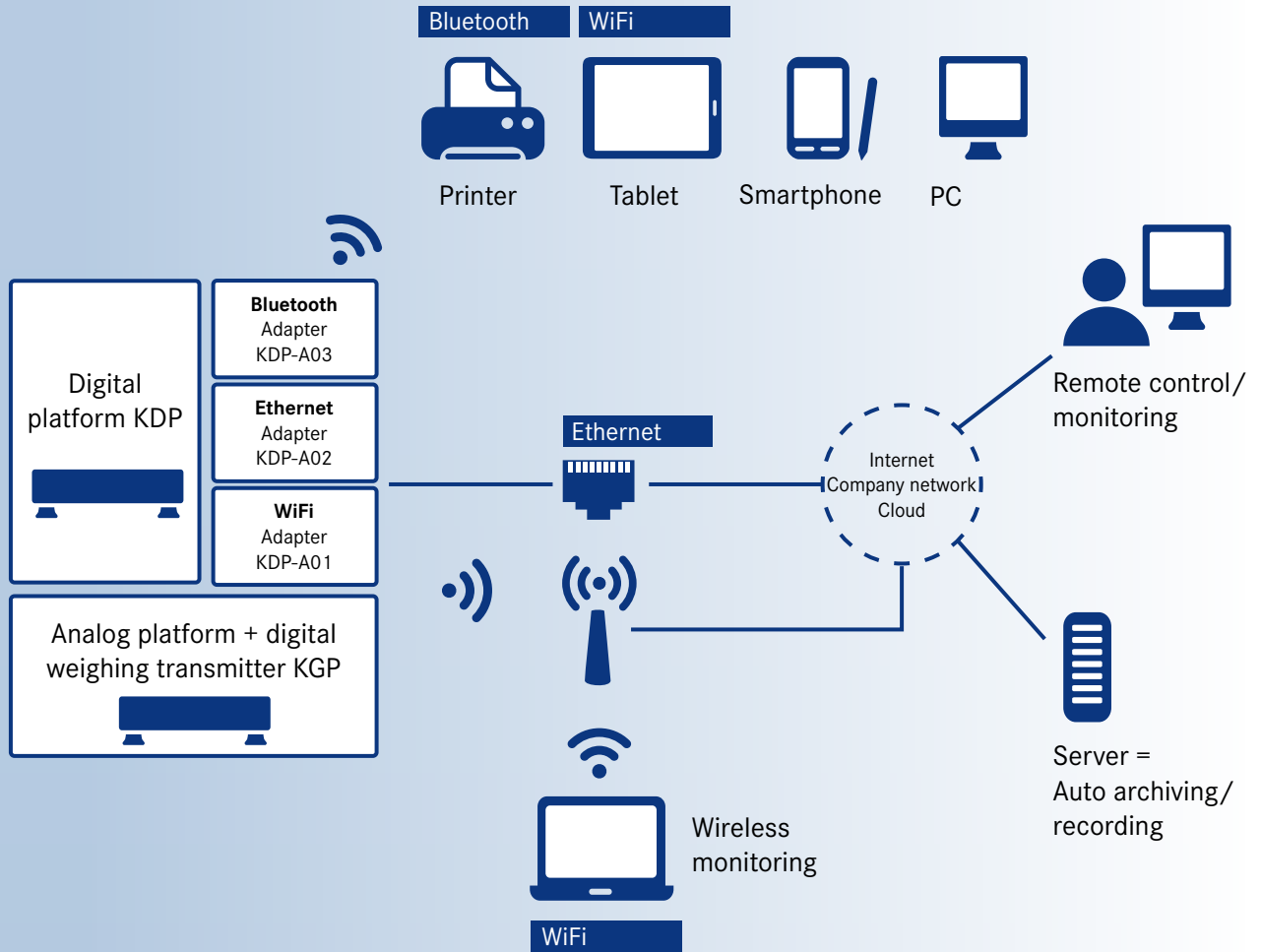

We will help to combine industrial production with the latest information and communication technology, with the aim of improving quality, reducing costs and using time and resources more efficiently so that you are able to react to future requirements in a more flexible manner. You will benefit from our uniform data protocol combined with our BalanceConnection 4.0 data software, for details please see page 174/175.

The KERN team in our centre of expertise – Industry 4.0



Daniel Egeler



Edgar Litti



Ralf Schmiege



Fabian Brenner

We would like to inform you and advise you

Tel. +49 7433 9933-200
ITsupport@kern-sohn.com



Sim. to illustration

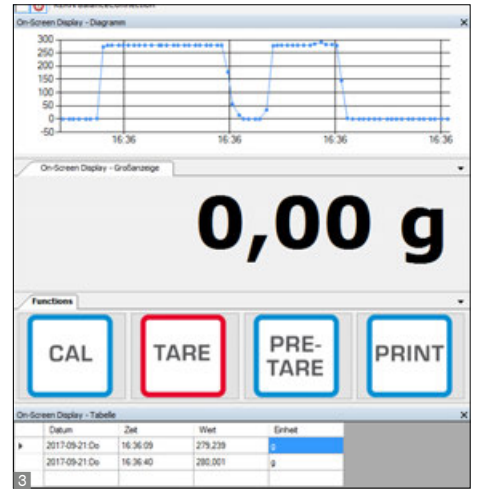

Robust industrial platform scale with digital weighing transmitter, ideal for varied range of applications for Industry 4.0

Features

- With this combination of 1 platform (KERN KFP V20 IP65) and digital weighing transmitter (KERN YKV-01) your weighing processes are ready for the requirements of Industry 4.0. Simply install the platform, connect the digital weighing transmitter to the network and start weighing
- For rapid transfer of weighing data to connected networks, computers, etc.
- USB and RS-232 data interface standard, Power supply via USB interface
- Transfer formats are freely configurable
- Functions: Weighing, taring
- Internal resolution 16 million divisions
- Measurement frequency 10 Hz
- Easy configuration using the software supplied
- KERN YKV-01: Robust plastic die-cast housing
- 2 KERN YKV-01: Suitable for wall mounting and DIN track mount (optional)

Included with delivery:

- Industrial platform KERN KFP
- Digital weighing transmitter KERN YKV-01
- DIN rail mounting bracket
- Configuration software for adjusting and managing the KERN KDP, for large-format display of the values collected on the PC as well as transfer of this data to other Apps and programs. The displayed result can therefore be converted to any format for communication with the different user programs, such as, for example, e.g. SAP, Oracle etc.

Technical Data

- Weighing plate material stainless steel
- KERN YKV: Overall dimensions W×D×H 100×127×28 mm
- Permissible ambient temperature -10 °C/ 40 °C

Accessories

- Bluetooth data interface, KERN YKV-A02, € 60,-
- WiFi data interface, KERN YKV-A01, € 60,-
- Ethernet data interface on request
- 2 DIN rail mounting bracket for KERN YKV, KERN YKV-A03, € 60,-
- 3 Software BalanceConnection, flexible recording or transfer of measurements, particularly to Microsoft® Excel or Access as well as transfer of this data to other Apps and programs. The displayed result can therefore be converted to any format for communication with the different user programs, such as, for example, e.g. SAP, for details see page 175, KERN SCD-4.0, € 150,-

STANDARD



OPTION



FACTORY



Model	Weighing capacity [Max] kg	Read-out [d] g	Weighing plate mm	Cable length m	Net weight approx. kg	Price excl. of VAT ex works €	Options	
							DAKKS KERN	Calibr. Certificate €
KGP 6K-4	6	0,2	300×240×120	3	6	430,-	963-128	94,-
KGP 6K-4L	6	0,2	400×300×128	3	10	450,-	963-128	94,-
KGP 10K-4	15	0,5	300×240×120	3	6	450,-	963-128	94,-
KGP 10K-4L	15	0,5	400×300×128	3	10	490,-	963-128	94,-
KGP 30K-3	30	1	300×240×120	3	6	450,-	963-128	94,-
KGP 30K-3L	30	1	400×300×128	3	10	490,-	963-128	94,-
KGP 60K-3	60	2	400×300×128	3	10	520,-	963-129	116,-
KGP 60K-3L	60	2	500×400×137	3	13	580,-	963-129	116,-
KGP 100K-3	150	5	500×400×137	3	14	580,-	963-129	116,-
KGP 100K-3L	150	5	650×500×142	3	22	780,-	963-129	116,-
KGP 300K-2L	300	10	650×500×142	3	22	780,-	963-129	116,-

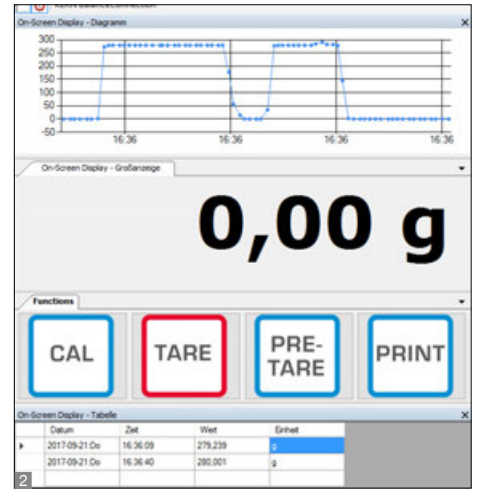

Modern digital weighing transmitter for the rapid recording of weighing data and forwarding it to the most varied output channels such as tablets, networks, SPS controllers, etc. – ideal for operating balances in systems or conveyors

Features

- With this digital weighing transmitter your weighing processes are ready for the requirements of Industry 4.0. Simply connect a weighing platform or measuring cell, integrate the digital weighing transmitter into the network and start weighing
- For rapid transfer of weighing data to connected networks, computers, etc.
- USB and RS-232 data interface standard, Power supply via USB interface
- Transfer formats are freely configurable
- Functions: Weighing, taring
- Measuring frequency 10 Hz
- Easy configuration using the software supplied
- Robust plastic die-cast housing
- Suitable for wall mounting and DIN track mount
- Compatible with all KERN weighing platforms

Included with delivery:

- Industrial platform KERN KFP
- USB cable incl. mains plug
- DIN rail mounting bracket
- Digital weighing transmitter KERN YKV-01
- Configuration software for adjusting and managing the KERN KDP, for large-format display of the values collected on the PC as well as transfer of this data to other Apps and programs. The displayed result can therefore be converted to any format for communication with the different user programs, such as, for example, e.g. SAP, Oracle etc.

Technical Data

- Overall dimensions W×D×H 100×127×28 mm
- Net weight approx. 1,2 kg
- Permissible ambient temperature -10 °C/40 °C

Accessories

- Bluetooth data interface, KERN YKV-A02, € 60,-
- WiFi data interface, KERN YKV-A01, € 60,-
- DIN rail mounting bracket for KERN YKV, KERN YKV-A03, € 60,-
- Software BalanceConnection, flexible recording or transfer of measurements, particularly to Microsoft® Excel or Access as well as transfer of this data to other Apps and programs. The displayed result can therefore be converted to any format for communication with the different user programs, such as, for example, e.g. SAP, for details see page 175, KERN SCD-4.0, € 150,-

STANDARD

CAL EXT | RS 232 | USB | LAN | KCP PROTOCOL | GLP PRINTER | UNIT | 1 DAY

YKV-02

FACTORY

BT 4.0 | WIFI

Model	Standard interfaces	Price excl. of VAT ex works €
KERN YKV-01	RS-232, USB	190,-
KERN YKV-02	RS-232, USB, Ethernet	240,-

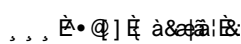

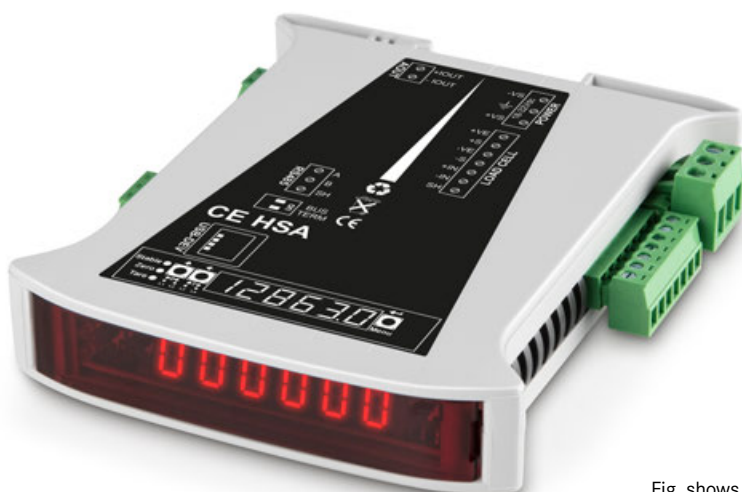

Fig. shows KERN CE HSA



Your contact for technical questions



Stefan Herrmann

Tel. +49 7433 9933-214
stefan.herrmann@kern-sohn.com

Super compact display device (rail-mounted module) for installation in switch cabinets

Features

- Compact display unit for recording weighing data using strain gauge load cells, e.g. in industrial applications
- Due to its small size, it is particularly space-saving to install in switch cabinets
- Thanks to the many interface variants, the modules can be ideally integrated into existing infrastructures and systems
- **A** The modules can be used either individually or as a Buslink system with a total of up to 332 DIN rail modules

- The configuration of the module can be carried out conveniently via a connected PC with the suitable software (Download see Internet)
- Bright LED display for optical control and settings
- Time-saving G-Cal™ (Geographic Calibration) technology for fast and accurate calibration without weights conveniently over a network or the Internet worldwide
- Convenient communication via remote devices
- Backup and restore function via USB port
- Can handle various industrial protocols such as Ethernet IP, Modbus TCP, Modbus RTU, FINS and Profibus DP

- Extremely high measurement frequency possible, up to 1600 data records/s
- Internal resolution 24 Bit

Technical Data

- LCD display, digit height 7,6 mm
- Dimensions W×D×H 101×120×22,5 mm
- Permissible ambient temperature -10 °C/40°C

Accessories

- Mains adapter for power supply of the KERN CE HS, mountable on DIN rail, KERN CE HSS, € 80,-

Features	Model KERN				
	CE HSA	CE HSE	CE HSN <small>NEW</small>	CE HSP	CE HSR
Power supply	18-32 Vdc; 4 W max.	18-32 Vdc; 4 W max.	18-32 Vdc; 4 W max.	18-32 Vdc; 4 W max.	18-32 Vdc; 4 W max.
Load cell power supply	5 Vdc	5 Vdc	5 Vdc	5 Vdc	5 Vdc
Sensitivity	0,1 µV/d	0,1 µV/d	0,1 µV/d	0,1 µV/d	0,1 µV/d
Adjustable nominal sensitivity	1; 1.5; 2; 2.5; 3 mV/V	1; 1.5; 2; 2.5; 3 mV/V	1; 1.5; 2; 2.5; 3 mV/V	1; 1.5; 2; 2.5; 3 mV/V	1; 1.5; 2; 2.5; 3 mV/V
Input voltage Unipolar @3mV/V	-1 mV to +16 mV	-1 mV to +16 mV	-1 mV to +16 mV	-1 mV to +16 mV	-1 mV to +16 mV
Input voltage Bipolar @3mV/V	-16 mV to +16 mV	-16 mV to +16 mV	-16 mV to +16 mV	-16 mV to +16 mV	-16 mV to +16 mV
A/D Conversion speed	1600/s	1600/s	1600/s	1600/s	1600/s
Max. load cell impedance	1200Ω	1200Ω	1200Ω	1200Ω	1200Ω
Min. load cell impedance	43,75 Ω	43,75 Ω	43,75 Ω	43,75 Ω	43,75 Ω
Max. no. of load cells 350 Ω	8	8	8	8	8
Max. no. of load cells 1000 Ω	22	22	22	22	22
Max. number of d	10.000	10.000	10.000	10.000	10.000
Display steps	1,2,5,10,20,50,100,200	1,2,5,10,20,50,100,200	1,2,5,10,20,50,100,200	1,2,5,10,20,50,100,200	1,2,5,10,20,50,100,200
Communication/Interfaces	USB	USB, Ethernet	USB, PROFINET	USB, PROFIBUS	USB, RS-232/-422
Analog output	0/4-20/24mA	-	-	-	-
Dimensions W×D×H	120×110×22 mm	120×110×22 mm	120×110×22 mm	120×110×22 mm	120×110×22 mm
Net weight g	150	150	150	150	150
Price excl. of VAT ex works €	480,-	540,-	540,-	540,-	510,-

NEW New model

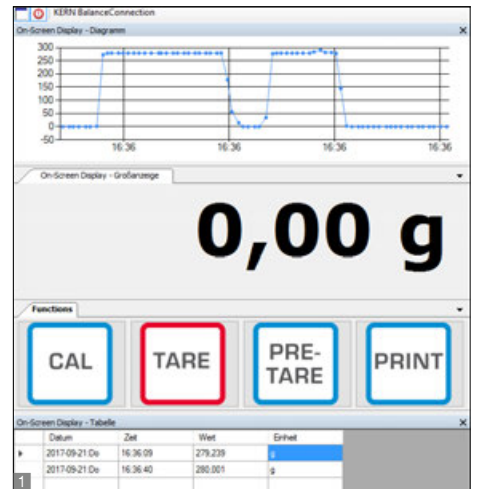

Universal weighing platforms for flexible connection into process chains

Features

- Industry 4.0 process chains: these weighing platforms can be easily integrated into your process chain. All recorded values can be easily transferred and processed further in your system as digital data and data that has already been compared using the many interfaces available. This saves cost, time and resources and ensures even more effective working
- Connecting the balance with a tablet or PC offers the advantage of being able to use the apps and programs which are on that device. These apps and programs are usually already tailored to your needs, are easy and convenient to use and can often be expanded as needed. This offers you the maximum level of flexibility when displaying, processing and saving the recorded weighing data
- Searching and remote control of the balance using external control devices or computers with the KERN Communication Protocol (KCP). KCP is a standardised interface command structure for KERN balances and other instruments which allows you to recall and

manage all relevant parameters and device functions. You can therefore simply connect KERN devices with KCP to computers, industrial control systems and other digital systems. In a large number of cases the KCP is compatible with the MT-SICS protocol

- PRE-TARE function for manual subtraction of a known container weight, useful for checking fill-levels
- Freely programmable weighing unit, e.g. display direct in special units such as length of thread g/m, paper weight g/m², or similar
- Level indicator and levelling feet for precise levelling of the scale, fitted as standard, to give the most accurate weighing result
- Draught shield standard for models with weighing plate size **A**, weighing space W×D×H 146×146×80 mm
- Included with delivery:
 - Software BalanceConnection for adjusting and managing the KERN KDP, for large-format display of the values collected on the PC as well as transfer of this data to other Apps and programs

Technical Data

- Dimensions weighing surface
 - A** Ø 105 mm
 - B** W×D 160×160 mm, see larger picture
- Weighing plate material
 - A** plastic, with conductive lacquer
 - B** stainless steel
- Overall dimensions W×D×H 165×166×75 mm (without draught shield)
- Cable length approx. 1,2 m
- Net weight approx. 1,2 kg
- Permissible ambient temperature 5 °C / 35 °C

Accessories

- Bluetooth data interface for wireless data transfer to PC or tablets, must be ordered at purchase, KERN KDP-A03, **€ 50,-**
- WiFi interface for wireless connection of the balance to networks and WiFi capable devices, such as tablets, laptops or smartphones, must be ordered at purchase, please ask for delivery time, KERN YMI-A01, **€ 90,-**
- Ethernet data interface, to connect an IP-based Ethernet network, must be ordered at purchase, not in combination with verification, KERN KDP-A02, **€ 100,-**

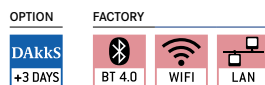
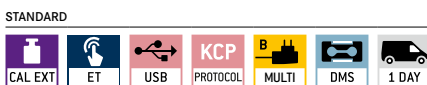

Model	Weighing capacity [Max] g	Read-out [d] g	Reproducibility g	Linearity g	Weighing plate mm	Price excl. of VAT ex works €	Options	
							DAKKS KERN	DAKKS Calibr. Certificate €
KDP 300-3	350	0,001	0,002	± 0,005	A	390,-	963-127	78,-
KDP 3000-2	3500	0,01	0,02	± 0,05	B	390,-	963-127	78,-
KDP 10K-4	10000	0,1	0,1	± 0,3	B	410,-	963-128	94,-
KDP 10K-3	10000	1	1	± 3	B	390,-	963-128	94,-

EasyTouch

by **KERN**



Welcome to the new age of weighing



KERN EasyTouch App – available in the Microsoft Store® (Windows® version)
or in the Google Play Store® (Android™ version)





The modular system solution for efficient weighing – perfect for your individual requirements

Just imagine, ...

- ... You only pay for functions which you actually use.
- ... You could develop the range of services of your balance to meet your requirements, whenever you want.
- ... You could easily control your balance from wherever you happen to be, in the laboratory, in production, in the office.
- ... You could do this from a PC, tablet or Smartphone.
- ... You could save the weighing data from your balances in a tamper-proof manner on a central server, whereby all the data is systematically stored in a database.

Then the KERN EasyTouch App (SET) is the perfect solution for you.



Large clear display for optimum view even under poor environmental conditions.

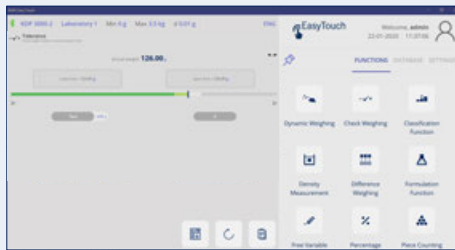

All installed functions are clearly arranged, enabling lightning-fast switching between functions.

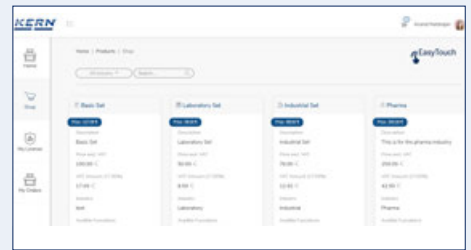

The functions can be adapted extensively to meet your particular requirements.

EasyTouch

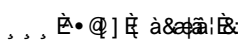



Make your weighing system into a powerful weighing system

Using the KERN EasyTouch App even a simple single scale can be made into a powerful weighing system, which offers a range of functions. To do this you simply have to install the KERN EasyTouch App on your PC, tablet or Smartphone (Windows® or Android®), connect the balance (either with cable or wireless), activate the App and straightaway you will be able to control your balance using your PC, tablet or Smartphone.

In order to find out about the many advantages of the KERN EasyTouch App, you can download a demo version of the App, which contains the full range of functions, i.e. you can get started straightaway and test all the functions in your own time!

In addition to the pre-installed functions the KERN EasyTouch App offers these additional handy functions:

- Large database for item master data, container weights, product images etc.
- Large database for dynamic weighing data (tamper-proof measurement value memory, logging of changes to master data, high level of data integrity, etc.)
- Access to the large database from all KERN EasyTouch functions
- Storage facility for an individual ID number or an object name for each weighing process or object in the tamper-proof Measurement value memory
- User ID with date and time is also saved for each weighing process
- Individual user administration (Administrator, User, permissions, ...), cross-functional

- Application of different weighing scales in one workflow (e.g. formulation or counting) possible, with full data-traceability (what item was measured on which weighing device)
- A large range of menu languages (DE, EN, FR, IT, ES)
- Individual print formats for printouts, including use of logos and free text
- It is possible to read barcodes using the connected barcode scanner
- All recorded weights can be printed from the individual functions using a connected network printer
- Convenient initial reading of large amounts of data, e.g. from an ERP, PPS, ... system, e.g. SAP®, and permanent synchronization of weighing and measurement data between the connected measuring instruments and the ERP, PPS, ... systems, e.g. SAP
- Compatible with Bluetooth 2.0 and 4.0
- Your KERN EasyTouch system can be expanded with many more, useful functions, which will make your daily work easier. Please see the table below or visit www.kern-sohn.com for information about all available functions

Can't find the function you need or do you have a particularly specific application?

Then you can simply program your own customised function yourself – or just ask us, our team of software specialists will be happy to help you.

This is how easy a powerful weighing system can work – with the KERN EasyTouch App

- Laptop, tablet or smartphone
- KERN EasyTouch App
- Suitable balances

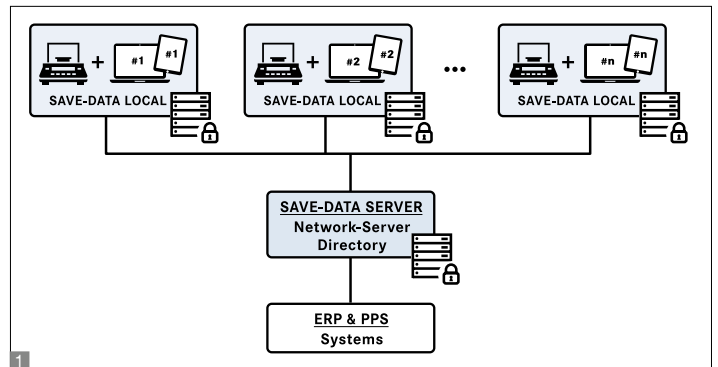

Test it – completely without risk!

► simple

Simply download the KERN EasyTouch function from the Microsoft Store® or Google Play®.

The KERN EasyTouch function already contains **all available functions** right from the start.

► tailor-made

The „**Basic Weighing Package**“ contains full database functionality. In addition they form the starting point for activating all other KERN EasyTouch functions. SET-01 OS forms the operating system with extensive basic functions. The operating system is the prerequisite for all other KERN EasyTouch Apps. All other apps can be customised on the basis of SET-01 OS.

► easy

Test it for 4 weeks, without obligation and free of charge!

After 4 weeks the functions go into sleep mode and you decide which functions you want to activate.

► extensive

Every function license purchased allows:

- 4 installations on PC, tablets or smartphones
- the installation of an unlimited number of scales, measuring cells etc.
- as well as use by as many users as you want
- for an unlimited period

Function	Application	Price
ET OS – Operating system Basic Weighing & Laboratory Package	(Mandatory for initial installation) Weighing, totalising (REZ A), targeted dispensing, percentage weighing	SET-01 € 690,-
ET Lab-Set Premium Laboratory Package	Contains: ET Recipe function (SET-21) + ET Difference function (SET-22)	SET-02 € 370,-
ET Formulation Recipe function	User administration (Administrator, User, etc.), recipe administration, component administration, targeted dispensing, multiplier function for the production of larger containers, bulk packs, etc., Adjustment of recipe when dosages are exceeded, recipe interrupt function Basic batch management, printout, etc.	SET-21 € 250,-
ET Difference Difference function	Monitoring function e.g. for monitoring the growth of biological cell cultures (monitoring of defined series of test through regular weighing in defined periods of time), the weight differences are calculated automatically and a graphic growth pattern is displayed and stored, automatic sample pan recognition by barcode is possible	SET-22 € 150,-
ET Industry set Premium Industrial Package	Contains: ET Tolerance weighing function (SET-31) + ET Piece-countingfunction (SET-32) + ET Target-counting function (SET-33)	SET-03 € 420,-
ET Tolerance Tolerance weighing function	Master data administration of items and their tolerances, numeric or percentage entry of the tolerance based on the target weight or limits, weighing process is supported audibly and with a colour bar graph, each weighing result can be stored with an ID number of the particular object (batch management)	SET-31 € 150,-
ET Count Piece-counting function	Master data administration of items with name in clear text, ID number, reference weight and tare weight, rapid counting function, can be a counting system, each weighing result can be stored with ID number of the particular object (batch management)	SET-32 € 150,-
ET Target-Count Target-counting function	Fill-to-target function: Target count or target weight can be programmed. When the target weight is reached there is an audible and visual signal, numeric or percentage entry of the tolerance based on the target weight or limits, master data administration of items with name in clear text, ID no., reference weight and tare weight, weighing result can be stored with an ID number of the particular object (batch management)	SET-33 € 150,-
ET Density Density determination function	Guidance through density determination of solid matter and liquids is particularly user-friendly and uses graphics, the density is calculated and output immediately	SET-04 € 150,-
ET Dynamic Animal and dynamic weighing function	Rapid entry facility for the time interval for a dynamic weighing process in seconds. Calculation of the average weight using the time interval which has been entered, also ideal for weighing where the weighing conditions are unstable	SET-05 € 35,-
ET Classify Classification function	Classification function for sorting objects into weight classes, you can name the classes as you wish, a further information field can be assigned to each class, e.g. price, etc., master data administration of items and their classes, the weighing result can be stored with an ID number of the particular object (batch management)	SET-06 € 150,-
ET Variable Free variable function	Free conversion function of the weight collected unit which can be individually named and defined (e.g. g/m = surface weight), output of the weight immediately in the defined unit, master data administration of items, the weighing result can be stored with an ID number of the particular object (batch management)	SET-07 € 50,-
ET Take-out Take-out function	Allows negative weighing (with take-out) from a source container, which is on the balance, visual and audible support of the take-out procedure, weight or piece display possible, statistical evaluation possible, such as, for example, average weight of the portions which have been taken out, total number of pieces which have been taken out, waste, etc., master data administration of items, the weighing result can be stored with an ID number of the particular object (batch management)	SET-08 € 100,-
ET Save-server Weight storage + Save-Server function	Allows the recorded weighing data to be saved in a shared folder or server workspace, for example	SET-10 € 450,-
ET Save-cloud Weight storage + Save-Server function in the Cloud	Central storage of weights and measurement data from different workplaces in the Cloud, tamper-proof	SET-101 € 30,-/month
ET Safety Precision & Safety function	<ul style="list-style-type: none"> Regular calibration function with individually specified test loads and defined tolerances. Warning and switch-off function, if test weighings are outside the tolerances. E.g. daily tests at defined test points with defined tolerance Management of the test weights used for the test with individual process time periods for each test weight, warning and switch-off function for invalid test weights Monitoring of the minimum sample weight (MinWeight = smallest weight to be weighed), warning and switch-off function for weighings below the permitted minimum weight Management of the verification or calibration of the balance used with individual process time periods for each balance, warning and switch-off function if the verification validity period or the defined recalibration period is exceeded 	SET-11 € 350,-

12

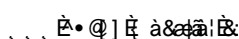



Weighing the easy way – Do you want to store weighing data digitally, simply but securely? You want your users to be supported in their weighing processes? You want to reduce or avoid measuring errors and process errors? Then extend the range of functions of your scale with the KERN EasyTouch App. Whether for complex recipes, for exact piece counting or for fast and effective portioning – KERN EasyTouch always has the right function. Faster working, more comfortable data management and higher process reliability are only some of the benefits of KERN EasyTouch – weighing the easy way.



1



2

Connection possibilities KERN EasyTouch:

- 1 wired via an RS-232 interface
- 2 wireless via Bluetooth

3 Suitable RS-232/USB adapter for connecting a tablet, PC etc. to scales or measuring instruments with RS-232 output, KERN AFH 13, € 95,-



3

The new KERN EasyTouch app – available right now for the following KERN ranges/models:

KERN Balances and Weighing platforms				Scales from other manufacturers
ADB / ADJ	GAB	NFN	UFA	Precisa Gravimetrics AG, CH
ALS / ALJ	IFB	NFB	KFB-TM	Mettler-Toledo International Inc., USA, CH
BFB	IOC ⁽¹⁾	PCB	KIB-TM ⁽¹⁾	
BFN	IXS	PLS / PLJ	KXS-TM	
BID ⁽¹⁾	KDP	SFB		
CKE	KGP	SXS		

⁽¹⁾ Verified operation: Weighing data from legally regulated uses can be stored and archived in KERN EasyTouch in conformity with standards, by using models from this product family with valid calibration and measurement value memory. This standard-compliant data storage also applies to SaveServer and SaveCloud.

Other KERN ranges can be adapted to be EasyTouch compatible – keep up-to-date with the latest new on www.kern-sohn.com



Albert Sauter Christoph Sauter Fabian Brenner

Our KERN EasyTouch specialists will gladly inform and advise you on all questions regarding the new KERN EasyTouch App

Tel. +49 7433 9933-200
ITsupport@kern-sohn.com



KERN EasyTouch App – available in the Microsoft Store® (Windows® version) or in the Google Play Store® (Android™ version)

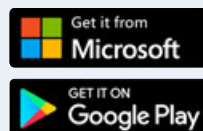

All details about the new KERN EasyTouch App can be found at www.kern-sohn.com/EasyTouch

13

Display devices/Platforms/Weighing bridges

Putting together individual weighing systems which cannot be verified

KERN offers a range of KERN display devices and KERN weighing units, such as platform scales, floor scales, pallet scales and drive-through scales, which you can put together to make your ideal scale. You choose the components, KERN handles the rest.

Assembly

KERN delivers the complete scale which is ready to use. Prices for assembly can be found in the "Assembly" price table. On request we can also create a calibration certificate in accordance with DAkkS/DKD at an additional price, see page 210 ff.

Putting together individual weighing systems which can be verified or are verified

In order to provide the complete package, as well as assembling your individual weighing system, KERN will also carry out the manufacturer's initial verification/evaluation for conformity in accordance with EC directives as a commercial scales of verification class III.

In accordance with the European verification regulations, when assembling a display device with a weighing unit you must take the following notes into account:

- Only elements which can be verified with type approval or OIML test certificate can be combined into a weighing system which can be verified. Possible models are marked with "M".
- Platforms with load cells, provided as third-party products which have an OIML test certificate can be included.
- It will not be possible to carry out verification at a later date, e.g. after assembly and delivery of the weighing system. So please order the verification at the same time as you order the weighing system.

You will find a wide variety of display devices, platforms, weighing bridges, etc. in KERN's product range and these can be put together to create your ideal scale. You simply choose the components, KERN handles the rest.

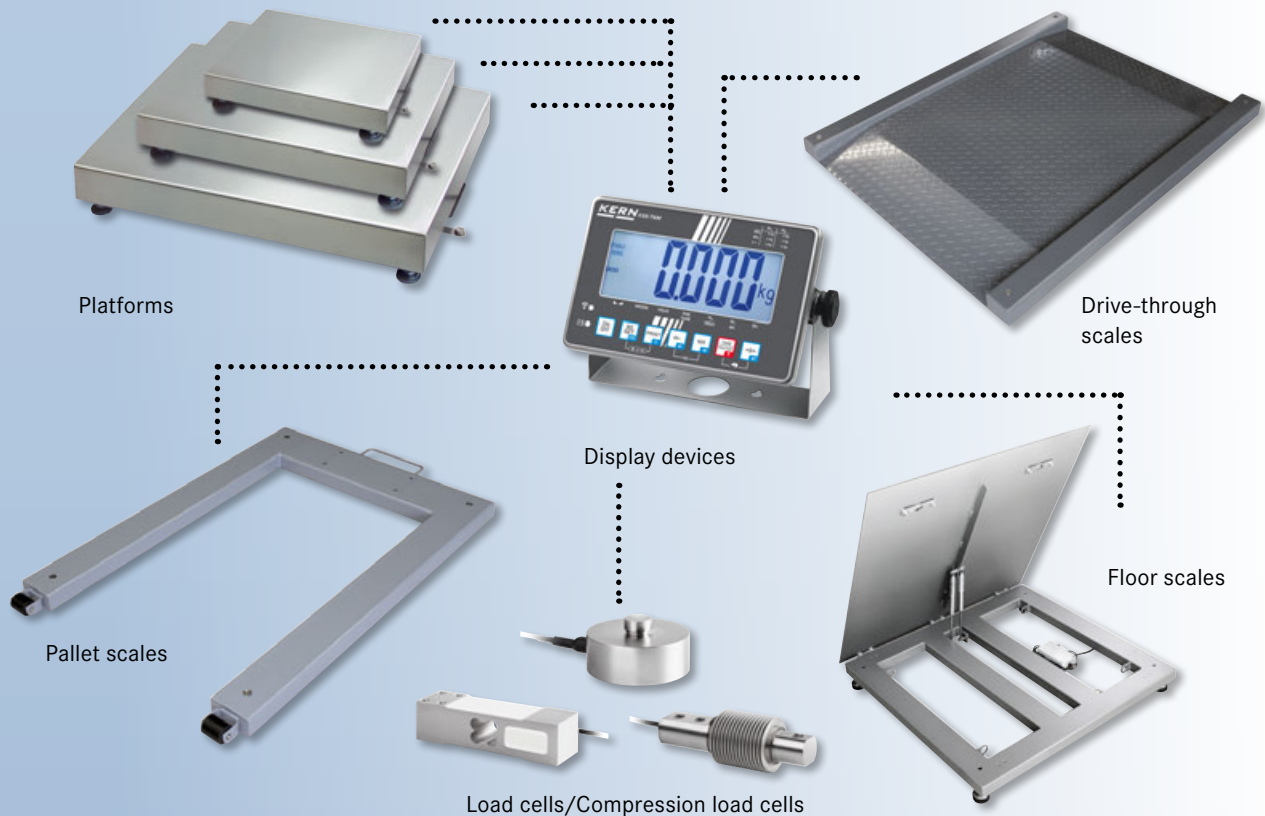

! Note

Individual scale construction according to your individual requirements, also possible with third-party components.

The individual KERN steps:

1. Proof of compatibility	Weighing capacity	Model	Price excl. of VAT, ex works €
This is mandatory by law and includes testing by using type approvals, whether the connection values of the display device match the connection data of the weighing unit.	0 up ... kg	KERN	
	all Weighing capacities	965-240	45,-
▼			
2. Assembly	up ≤ 50 kg	965-411	70,-
After testing for suitability using the proof of compatibility, the weighing system will be hard wired by KERN. The weighing system will then be tested in accordance with regulations of 2014/31/EU, the European directive for non-automatic weighing instruments and prepared for conformity assessment.	up ≤ 350 kg	965-412	100,-
	up ≤ 1500 kg	965-413	120,-
	up ≤ 2900 kg	965-414	150,-
	up ≤ 6000 kg	965-415	250,-
	▼		
3. Initial verification by the manufacturer Conformity assessment ("Initial verification by the manufacturer")	up ≤ 5 kg	965-227	55,-
KERN is authorised to carry out the conformity assessment ("initial verification by the manufacturer") in accordance with 2014/31/EU, the European directive for non-automatic weighing instruments and is therefore authorised to introduce the weighing system onto the market, after the test has been carried out successfully and the conformity mark has been affixed.	up ≤ 50 kg	965-228	70,-
	up ≤ 350 kg	965-229	93,-
	up ≤ 1500 kg	965-230	132,-
	up ≤ 2900 kg	965-231	150,-
	up ≤ 6000 kg	965-232	200,-
	▼		
4. Declaration of conformity			
KERN issues this after the initial verification by the manufacturer Conformity assessment has been carried out successfully and sends it with the weighing system at no additional cost, and it can be used in areas regulated by law.			

Modifications and special services

Description	Model	Price excl. of VAT, ex works €
	KERN	
Cable extensions for platform scales		
up to 4 m extension	965-403	45,-
up to 7 m extension	965-404	60,-
up to 10 m extension	965-405	75,-
Setting an individual preload		
Balance with build-type approval	965-401	50,-
Balance without build-type approval	920-406	60,-
Other adjustments in the balance or software changes	965-407	95,-/h
Plug connection (replaces the fixed cable connection between the display device and platform with a plug connection which can be disconnected)		
balances with type approval and verification (according to time spent)		only possible with separable, verifiable plug connection with identification chip (e.g. KERN KIB-A12), for the corresponding models (e.g. IOC, BID, UID) please order when purchasing
balances with type approval, no verification	965-406	60,-

Order example

	Model	Price excl. of VAT, ex works €
KFP 30V20M platform and KEN-TM display device with cable extension (4 m) and setting an individual preload.	KERN	
KERN platform	KFP 30V20M	230,-
KERN display device	KFN-TM	290,-
Proof of compatibility	965-240	45,-
Cable extension	965-403	45,-
Setting the preload	965-401	50,-
Assembly	965-411	70,-
Verification at the factory KERN	965-228	70,-
Complete scale (verified)		800,-



1 KERN KFB-TM

Display device with large digits
– easy to read

2 KERN KFS-TM

Professional indicator with 3 displays,
also with EC type approval [M]



to see what options are offered by this display device, please see the KERN platform scale IFB on page 103



to see what options are offered by this display device, please see the KERN counting scale IFS on page 85

STANDARD

CAL EXT ET RS 232 KCP GLP PRINTER PCS SUM UNIT

STANDARD OPTION FACTORY

TOL MOVE MULTI 1 DAY ACCU BT 2.0 ANALOG M

STANDARD

CAL EXT MEMORY RS 232 KCP GLP INTERN PCS SUM PERCENT

STANDARD OPTION FACTORY

UNIT TOL MULTI 1 DAY ACCU M

* not possible in combination with verification
** not possible in combination with signal lamp

Features	Model KERN	
	1 KFB-TM	2 KERN KFS-TM
Display (segments)	5 + ½ digits	6 digits
EC type approval	yes	yes
Resolution verifiable	6000 e	3000 e
Resolution non verifiable	30000 d	60000 d
Weighing capacities	≤ 2	≤ 2
Weighing units	kg, lb	kg, g
Readability	1, 2, 5, 10, n	1, 2, 5, 10, n
Piece counting with reference	10, 20, 50, 100, 200	n
Display, digit height	Backlit LCD display, 52 mm	Backlit LCD displays, 13/16,5 mm
Additional functions	Totalising, HOLD function	99 item memories, totalising, printing of date and time
Strain gauge load cells	87 – 1600 Ω	87 – 1600 Ω
Linearisation	3 points	4 points
Input voltage	12 V, 500 mA	12 V, 500 mA
Permissible ambient temperature	-10 °C/40 °C	0 °C/40 °C
Interface RS-232	yes	yes
2. Interface RS-232, separate Y cable	CFS-A04, € 35,-	CFS-A04, € 35,-
Interface RS-485	-	-
Interface USB	-	-
Interface Bluetooth	KERN KFB-A03, see page 103, € 130,-	-
Analogue module	0–10V: KERN KFB-A04, € 95,-; 4–20 mA: KERN KFB-A05, € 95,-; see page 103	-
Signal lamp	CFS-A03, € 250,-	CFS-A03, € 250,-
Foot switch	-	-
Stand	BFS-A07, see page 103, € 120,-	BFS-A07, see page 85, € 120,-
Benchtop stand for display device/wall mount	yes/yes	yes/yes
Protective working cover	KFB-A02S05, see page 103, € 40,-	KFB-A02S05, see page 85, € 40,-
Rechargeable battery pack	KFB-A01, see page 103, € 35,-	KFS-A01, see page 85, € 35,-
Operating/charging time	up to 35 h/12 h	up to 40 h/12 h
Dimensions Housing W×D×H	250×160×65 mm	260×150×65 mm
Net weight	1,2 kg	1,5 kg
Price excl. of VAT, ex works €	190,-	210,-

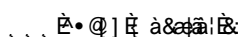

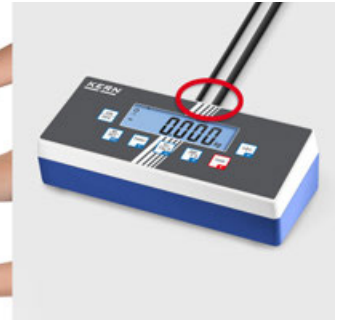

3 KERN KIB-TM

Practical Flip/Flop display device for greatest ease of use

- Practical Flip/Flop display device: flexible positioning e.g. free-standing or screwed to the wall (optional). By rotating the upper housing shell you can determine the angle of the display as well as the cable outlet. Factory Option ex works for an additional cost, delivery time + 2 working days, KERN KIB-M01, € 95,-
- Industry 4.0: A large number of (optional) data interfaces enable convenient transferring weighing data to tablets, laptops, PCs, networks, smartphones, printers, etc.

- Searching and remote control of the balance using external control devices or computers with the KERN Communication Protocol (KCP). KCP is a standardised interface command structure for KERN balances and other instruments which allows you to recall and manage all relevant parameters and device functions. You can therefore simply connect KERN devices with KCP to computers, industrial control systems and other digital systems. In a large number of cases the KCP is compatible with the MT-SICS protocol. Only possible through RS-232 data interface, other interfaces on request.

In the KERN product range you will find a large number of platforms, weighbridges etc. which you can combine with the KERN KIB-TM display device. Simply select the components, KERN will take care of the rest.

* Verification not in combination with KERN KIB-A02, KIB-A03, KIB-A04, KIB-A10

** Note: In addition to the RS-232 data interface, which is integrated as standard, only one other data interface can be installed and operated

STANDARD

OPTION

FACTORY

Features	Model KERN
	3 KIB-TM
Display (segments)	6 digits
EC type approval	yes
Resolution verifiable	6000 e
Resolution non verifiable	60000 d
Weighing capacities	≤ 2
Weighing units	kg, g
Readability	1, 2, 5, 10, n
Piece counting with reference	5, 10, 20, 25, 50, 100
Display, digit height	Backlit LCD display, 24 mm
Additional functions	Totalising, HOLD function, printing of time. KCP Only possible through RS-232; USB, Bluetooth, WiFi, Digital I/O, LAN on request
Strain gauge load cells	87-1100 Ω
Linearisation	3 points
Input voltage	12 V DC, 1000 mA
Permissible ambient temperature	-10 °C/40 °C
Interface RS-232	yes
Interface RS-485	-
Interface USB	KIB-A03**, see page 102, € 120,-
Interface Bluetooth	KIB-A04**, see page 102, € 110,-
WiFi	KIB-A10**, see page 102, € 120,-
SWITCH (DIGITAL I/O)	-
LAN	KIB-A02**, see page 102, € 150,-**
Alibi memory	KIB-A01, € 150,-
Stand	EOC-A05, see page 102, € 60,-
Benchtop stand for display device/wall mount	EOC-A04, € 30,-
Protective working cover	EOC-A01S05, € 40,-
Rechargeable battery pack	KFB-A01, see page 102, € 35,-
Operating/charging time	up to 43 h/3 h
Dimensions Housing W×D×H	268×115×70 mm
Net weight	0,8 kg
Price	190,-
excl. of VAT, ex works €	

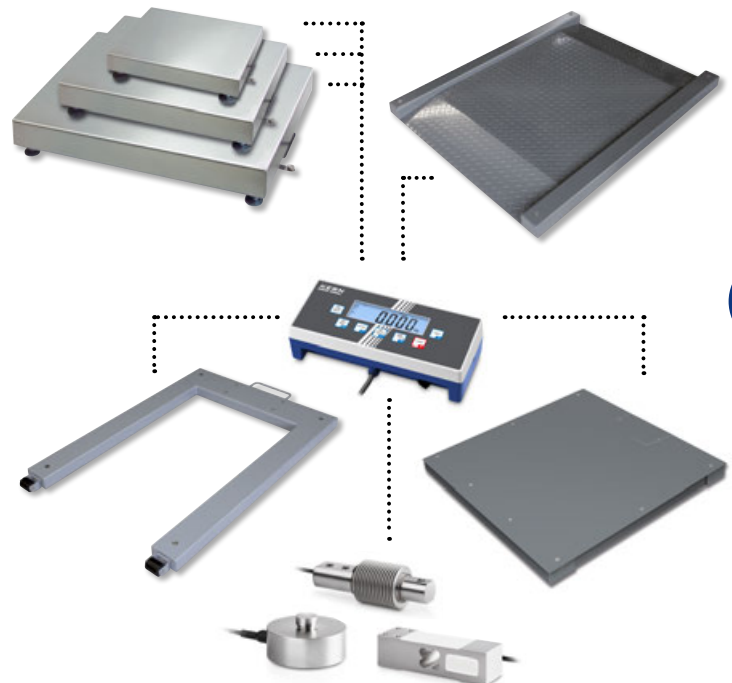

! Tip

to see what options are offered by this display device, please see the KERN platform scale IOC on page 102



4 KERN KFE-TM

Stainless steel display device with IP65 protection

5 KERN KFN-TM

Stainless steel display device with IP65 protection and superior display size

6 KERN KXS-TM

Stainless steel display device with IP68 protection and integrated power supply



to see what options are offered by this display device, please see the KERN SFE platform scale on page 105



to see what options are offered by this display device, please see the KERN SFB platform scale on page 71



to see what options are offered by this display device, please see the KERN SXS platform scale on page 72

STANDARD

CAL EXT, SUM, TOL, MOVE, IP 65, ACCU, MULTI

STANDARD FACTORY

1 DAY, M

STANDARD

CAL EXT, KCP, PROTOCOL, PCS, SUM, TOL, MOVE, IP 65

STANDARD OPTION FACTORY

MULTI, 1 DAY, RS 232, ACCU, M

STANDARD

CAL EXT, ET, PCS, SUM, UNIT, TOL, MOVE

STANDARD

IP 68, 230 V, 1 DAY

OPTION FACTORY

RS 232, RS 485, BT 2.0, ACCU, M

**

** not possible in combination with verification

Features	Model KERN 4 KFE-TM*	Model KERN 5 KFN-TM	Model KERN 6 KXS-TM
Display (segments)	6 digits	5 + 1/2 digits	6 digits
EC type approval	yes	yes	yes
Resolution verifiable	6000 e	6000 e	10000 e
Resolution non verifiable	30000 d	30000 d	30000 d
Weighing capacities	≤ 2	≤ 2	≤ 2
Weighing units	kg	kg	kg, g
Readability	1, 2, 5, 10, n	1, 2, 5, 10, n	1, 2, 5, 10, 50
Piece counting with reference	-	10, 20, 50, 100, 200	10, 20, 50, 100, 200
Display, digit height	Backlit LCD display, 22 mm	Backlit LCD display, 52 mm	Backlit LCD display, 55 mm
Additional functions	-	Totalising, HOLD function	PRE-Tare function, totalising, HOLD function, peak hold, zero-point memorisation
Strain gauge load cells	87 – 1200 Ω	87 – 1600 Ω	87 – 1600 Ω
Linearisation	2 points	2 points	2-7 points
Input voltage	12 V, 500 mA	12 V, 500 mA	220-240 V AC
Permissible ambient temperature	-10 °C/40 °C	-10 °C/40 °C	-10 °C/40 °C
Interface RS-232	-	KFN-A01, see page 71, € 95,-	KXS-A04, € 100,-
Interface RS-485	-	-	KXS-A01, € 145,-
Interface USB	-	-	-
Interface Bluetooth	-	-	KXS-A02, € 170,- (balance ► PC)
Foot switch	-	-	KXS-A03, € 130,-
Stand	-	BFS-A07, see page 71, € 120,-	YKP-02, € 190,-
Benchtop stand for display device/wall mount	yes/yes	yes/yes	yes/yes
Protective working cover	-	-	-
Rechargeable battery pack	standard	GAB-A04, € 40,-	GAB-A04, € 40,-
Operating/charging time	up to 45 h/12 h	up to 35 h/12 h	up to 80 h/12 h
Dimensions Housing W×D×H	195×118×83 mm	266×165×96 mm	232×170×80 mm
Net weight	1 kg	2,6 kg	2,5 kg
Price excl. of VAT, ex works €	250,-	290,-	300,-

* ONLY WHILE STOCKS LAST!

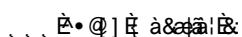



1 KERN KFP-V20 IP65

Platform

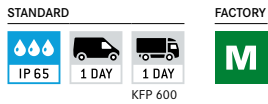

- Stainless steel-weighing plate, **A** Painted steel base
- 1 load cell, aluminium, silicone-coated, IP65, OIML-R60-approved, class III, 3000 e
- Level indicator and levelling feet for precise levelling of the scale

2 KERN KXP-V20 IP65

Platform



- Stainless steel-weighing plate, **B** Painted steel base, extremely rigid, wing design
- 1 load cell, aluminium, silicone-coated, IP65, OIML-R60-approved, class III, 3000 e
- Level indicator and levelling feet for precise levelling of the scale



Model	Weighing range [Max] kg	Readability [d] g	Verification value [e] g	Min. load [Min] g	Cable length approx. m	Net weight approx. kg	Weighing plate W×D×H mm	Price excl. VAT, ex works €
1 Platform KFP-V20 IP65								
KFP 3V20M	3	0,1	1	20	2,5	3,6	230×230×110	160,-
KFP 6V20M	6	0,2	1 2	40	2	3,6	230×230×110	170,-
KFP 6V20LM	6	0,2	1 2	40	2,5	6	300×240×110	190,-
KFP 15V20M	15	0,5	2 5	100	2	6	300×240×110	190,-
KFP 15V20LM	15	0,5	2 5	100	2,5	10	400×300×125	230,-
KFP 30V20SM	30	10	10	200	2,5	6	300×240×110	195,-
KFP 30V20M	30	1	5 10	200	2	10	400×300×125	230,-
KFP 60V20M	60	2	10 20	400	2	10	400×300×125	230,-
KFP 60V20LM	60	2	10 20	400	2	10	500×400×137	290,-
KFP 150V20M	150	5	20 50	1000	2	10	500×400×137	290,-
KFP 150V20LM	150	5	20 50	1000	2	22	650×500×135	510,-
KFP 300V20M	300	10	50 100	2000	2	22	650×500×135	510,-
KFP 600V20AM	600	200	200	4000	2,5	46	800×600×150	780,-
2 Platform KXP-V20 IP65								
KXP 6V20LM	6	0,2	1 2	40	3	3,2	300×240×90	230,-
KXP 15V20M	15	0,5	2 5	100	3	3,2	300×240×90	230,-
KXP 15V20LM	15	5	5	100	3	8	400×300×90	320,-
KXP 30V20M	30	1	5 10	200	3	8	400×300×89	320,-
KXP 30V20LM	30	1	5 10	200	3	18	500×400×123	450,-
KXP 60V20M	60	2	10 20	400	3	11	400×300×89	330,-
KXP 60V20LM	60	2	10 20	400	3	22	500×400×123	460,-
KXP 150V20M	150	5	20 50	1000	3	18	500×400×123	450,-
KXP 150V20LM	150	5	20 50	1000	3	34	650×500×133,5	540,-
KXP 300V20M	300	10	50 100	2000	3	34	650×500×133,5	540,-

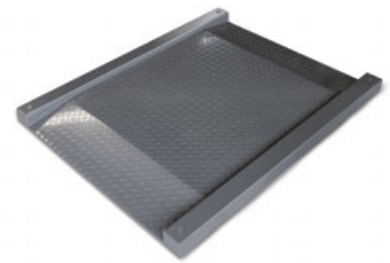
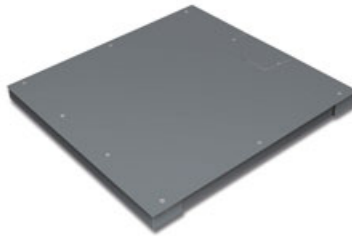
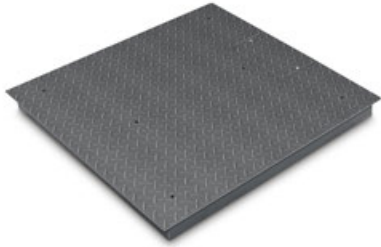

3 KERN KIP-V20M

Weighing bridge



- Weighing bridge with non-slip chequer plate, lacquered, welded
- 4 Load cells, steel, silicone-coated, IP67, OIML-R60-approval for verification, class III, 3000 e
- Can be built in using pit frames (optional)
- Level indicator and levelling feet for precise levelling of the scale
- Easy access to the junction box from the top
- Comfortable levelling of the weighing bridge from the top
- Accessories see KERN BID, page 113/114

4 KERN KFP-V20 IP67

Weighing bridge



- Weighing plate screwed on from the top (models with [Max] ≤ 1500 kg), so it easy to remove, hygienic and easy to clean.
- Lacquered steel weighing bridge, weighing plate size 1500×1500×130 mm corrugated steel plate. Extremely resistant to bending due to material thickness
- 4 Load cells, steel, silicone-coated, IP67, OIML-R60-approval for verification, class III, 3000 e
- Can be built in using pit frames (optional)
- Level indicator and levelling feet for precise levelling of the scale
- Easy access to the junction box from the top
- Comfortable levelling of the weighing bridge from the top
- Accessories see KERN BFB, page 115/116

5 KERN KFD-V20

Weighing bridge



- Weighing bridge made of non-slip corrugated steel plate, lacquered, two access ramps integrated, extremely resistant to bending
- Extremely flat construction to facilitate access: access height only 45 mm
- 4 Load cells, alloy steel, silicone-coated, IP67, OIML-R60-approved class III, 3000 e
- Accessories see KERN NFB page 124



Model	Weighing range [Max] kg	Readability [d] g	Verification value [e] g	Min. load [Min] g	Cable length approx. m	Net weight approx. kg	Weighing plate W×D×H mm	Price excl. VAT, ex works €
3 Weighing bridge KIP-V20M								
KIP 600V20SM	600	200	200	4000	5	130	1000×1000×108	980,-
KIP 600V20M	600	200	200	4000	5	150	1500×1200×108	1250,-
KIP 1500V20SM	1500	500	500	10000	5	130	1000×1000×108	1230,-
KIP 1500V20EM	1500	500	500	10000	5	140	1250×1000×108	1070,-
KIP 1500V20M	1500	500	500	10000	5	150	1500×1250×108	1440,-
KIP 3000V20M	3000	1000	1000	20000	5	150	1500×1250×108	1240,-
KIP 3000V20LM	3000	1000	1000	20000	5	180	1500×1500×108	1420,-
4 Weighing bridge KFP-V20 IP67								
KFP 600V20SNM	600	200	200	4000	5	105	1000×1000×80	1050,-
KFP 600V20NM	600	200	200	4000	5	135	1500×1250×80	1420,-
KFP 1500V20SNM	1500	500	500	10000	5	105	1000×1000×80	1050,-
KFP 1500V20NM	1500	500	500	10000	5	135	1500×1250×90	1480,-
KFP 1500V20LNM	1500	500	500	10000	5	185	1500×1500×130	1550,-
KFP 3000V20NM	3000	1000	1000	20000	5	135	1500×1250×90	1440,-
KFP 3000V20LNM	3000	1000	1000	20000	5	155	1500×1500×80	1650,-
KFP 6000V20M	6000	2000	2000	40000	5	210	1500×1500×130	1950,-
5 Weighing bridge KFD-V20								
KFD 600V20M	600	200	200	4000	5	125	1600×1200×78	1400,-
KFD 600V20LM	600	200	200	4000	5	155	1800×1400×80	1600,-
KFD 1500V20M	1500	500	500	10000	5	125	1600×1200×78	1390,-
KFD 1500V20LM	1500	500	500	10000	5	175	1800×1400×78	1600,-

Price reduction



6 KERN KFA-V20

Weighing beams

STANDARD

IP 67 2 DAYS

- Weighing beams and painted steel base
- 4 load cells, alloy steel, silicone-coated, IP67
- Levelling feet for precise levelling of the weighing beams
- **D** Image below: Version up to 6 t available. Each weighing beam has a roller and handle for easy transport of the scale (KERN KFA-L)
- **NEW:** new model with short weighing beams, ideal for weighing compact items or animals in transport boxes
 - ▶ KERN KFA-600V20S
- Accessories see KERN UFA, page 118

7 KERN KFU-V20/V30

U-Weighing bridge

STANDARD FACTORY

IP 67 2 DAYS **M**

- Load range: painted steel (V20), stainless steel (V30) height 90 mm
- 4 load cells, alloy steel, silicone-coated, IP67, OIML-R60-approval for verification, class III, 3000 e
- 2 rollers and handle for easy transport of the scale
- Accessories KFU-V20 see KERN UFB, page 121
- Accessories KFU-V30 see KERN UFN, page 122

8 KERN KFP-V30

Platform

STANDARD FACTORY

IP 67 2 DAYS **M**

- Stainless steel-weighing plate, **E** Stainless steel substructure
- 1 load cell, Stainless steel, silicone-coated, IP67, OIML-approved, class III, 3000 e
- Level indicator and levelling feet for precise levelling of the scale



Model	Weighing range [Max] kg	Readability [d] g	Verification value [e] g	Min. load [Min] g	Cable length approx. m	Net weight approx. kg	Weighing plate W×D×H mm	Price excl. VAT, ex works €
6 Weighing beams KFA-V20								
KFA 600V20S	600	200	-	-	5	30	800×120×100	690,-
KFA 1500V20	1500	500	-	-	5	36	1200×120×100	760,-
KFA 3000V20	3000	1000	-	-	5	36	1200×120×100	780,-
KFA 3000V20L	3000	1000	-	-	5	65	2000×120×100	1150,-
KFA 6000V20	6000	2000	-	-	5	85	1200×160×80	1220,-
KFA 6000V20L	6000	2000	-	-	5	125	2100×160×85	1550,-
7 U-Weighing bridge KFU-V20								
KFU 600V20M	600	200	200	4000	5	55	840×1350×90	830,-
KFU 1500V20M	1500	500	500	10000	5	55	840×1350×90	830,-
7 Stainless steel U-Weighing bridge KFU-V30								
KFU 600V30M*	600	200	200	4000	2,5	55	840×1350×90	1240,-
KFU 1500V30M*	1500	500	500	10000	2,5	55	840×1350×90	1540,-
8 Stainless steel platform KFP-V30								
KFP 15V30M	15	0,5	5	100	2,5	5,0	300×240×100	490,-
KFP 30V30SM	30	10	10	200	2,5	5,0	300×240×100	490,-
KFP 30V30M	30	1	10	200	2,5	10	400×300×128	540,-
KFP 60V30M	60	2	20	400	2,5	10	400×300×128	550,-
KFP 60V30LM	60	2	20	400	2,5	10	500×400×137	650,-
KFP 60V30XLM	60	2	20	400	2,5	22	650×500×142	990,-
KFP 150V30SM	150	5	50	1000	2,5	10	400×300×128	540,-
KFP 150V30M	150	5	50	1000	2,5	10	500×400×137	660,-
KFP 150V30LM	150	5	50	1000	2,5	22	650×500×135	990,-
KFP 300V30M	300	10	100	2000	2,5	22	650×500×135	990,-

* ONLY WHILE STOCKS LAST!



9 KERN KFP-V40

Weighing bridge

STANDARD FACTORY

IP 68 2 DAYS M

- Weighing bridge entirely made of stainless steel, extremely resistant to bending because of its high material thickness
- **F** Weighing plate fixed with stainless steel screws, for easier access to the loadcells from above
- 4 load cells, stainless steel, encapsulated, IP68, OIML-R60-approved, class III, 3000 e
- Can be built in using pit frames (optional)
- Level indicator and levelling feet for precise levelling of the scale
- Comfortable levelling of the weighing bridge from the top
- Accessories see KERN BFN, page 117

10 KERN KFD-V40

Weighing bridge

STANDARD FACTORY

IP 68 2 DAYS M

- Weighing bridge made from stainless steel, two integrated access ramps, extremely resistant to bending
- Extremely flat construction to facilitate access: access height only 45 mm
- 4 load cells, stainless steel, encapsulated IP68, OIML-R60-approval for verification, class III, 3000 e
- Level indicator and levelling feet for precise levelling of the scale
- Accessories see KERN NFN, page 125

! Tip

We will be happy to create custom products for you, such as, for example weighing plates with holes and hooks in place of handles, other weighing plate sizes, other materials (steel grades) and much more.



Model	Weighing range [Max] kg	Readability [d] g	Verification value [e] g	Min. load [Min] g	Cable length approx. m	Net weight approx. kg	Weighing plate W×D×H mm	Price excl. VAT, ex works €
9 Stainless steel weighing bridge KFP-V40								
KFP 600V40SM	600	200	200	4000	5	95	1000×1000×80	2400,-
KFP 1500V40M	1500	500	500	10000	5	135	1500×1250×80	3000,-
KFP 1500V40SM	1500	500	500	10000	5	95	1000×1000×80	2650,-
KFP 3000V40M	3000	1000	1000	20000	5	135	1500×1250×80	3000,-
10 Stainless steel weighing bridge KFD-V40								
KFD 600V40M	600	200	200	4000	5	130	1600×1200×78	2700,-
KFD 1500V40M	1500	500	500	10000	5	130	1600×1200×78	2700,-

ONLY WHILE STOCKS LAST!

Price reduction

Measuring cells

Accuracy classes with nominal loads from 300 g to 100 t and protection classes up to IP69K as well as cells protected according to ATEX or OIML approved cells are available to you from now in the SAUTER product range. Whatever the project – whether it's the development of customised weighing systems, installation in silos and storage tanks or in shelving for continuous inventory, for special application in mechanical engineering or in any type of test bench – SAUTER can offer you just the right measuring cell.

Of course, we can also supply you with the appropriate accessories such as load corners, pivot heads, display devices, junction boxes or the relevant calibration certificate at the same time.

Any special requests? Do you need special load cells, other capacities or cable lengths, individual force test benches or a special mount for your test item? No problem, our product specialist for force-measuring cells Mr Stefan Herrmann is available at any time to help you further and will work with you to develop a customised concept for your application.

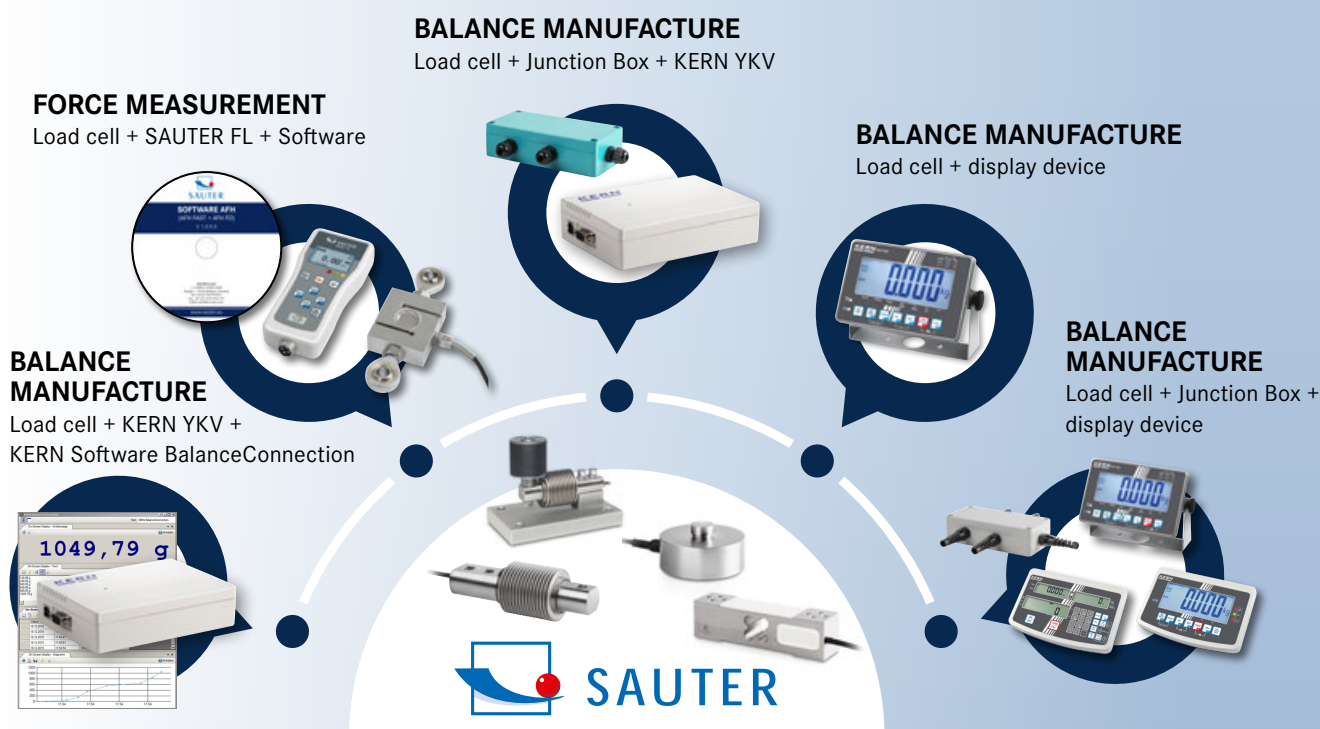

SAUTER measuring cells – integration opportunities



CP P4

Single-point load cells made of anodised aluminium

STANDARD: IP 65, 1 DAY
 OPTION: DAKkS +3 DAYS, ISO +4 DAYS

- CE and RoHS compliant
- Accuracy in accordance with OIML R60: CP Y4: C, CP P4: L
- Dust and spray protection to IP65 (in accordance with EN 60529)
- Aluminium, anodised
- Suitable for price-computing scales, bench scales, platform scales, etc.
- Maximum platform size CP Y4: 120×120 mm, CP P4: 200×200 mm
- 4-wire connection
- Nominal sensitivity: 0,9 mV/V

CP P1

Single-point load cells made of anodised aluminium

STANDARD: IP 65, M, 1 DAY
 OPTION: DAKkS +3 DAYS, ISO +4 DAYS

- Accuracy in accordance with OIML R60: CP P1: C3, CP Y1: C2
- CE and RoHS compliant
- Dust and spray protection to IP65 (in accordance with EN 60529)
- Aluminium, anodised
- Suitable for price-computing scales, bench scales, platform scales, etc.
- Maximum platform size 250×350 mm
- 4-wire connection
- Nominal sensitivity: 2 mV/V
- Note: Version in accordance with OIML R60 C4 or C5 on request

CP P3

Single-point load cells made of anodised aluminium

STANDARD: IP 65, 1 DAY
 OPTION: DAKkS +3 DAYS, ISO +4 DAYS

- Accuracy in accordance with OIML R60 C3
- CE and RoHS compliant
- Dust and spray protection to IP65 (in accordance with EN 60529)
- Suitable for price-computing scales, bench scales, platform scales, etc.
- Maximum platform size 350×400 mm
- 4-wire connection
- Nominal sensitivity: 2 mV/V
- Note: Version in accordance with OIML R60 C4 on request

Model	Nominal load	Price excl. of VAT ex works €
KERN	kg	
CP 300-0P4	0,3	60,-
CP 600-0P4	0,6	60,-

Model	Nominal load	Price excl. of VAT ex works €
KERN	kg	
CP 3-3P1	3	50,-
CP 5-3P1	5	50,-
CP 6-3P1	6	50,-
CP 8-3P1	8	50,-
CP 10-3P1	10	50,-
CP 15-3P1	15	50,-
CP 20-3P1	20	50,-
CP 30-3P1	30	50,-
CP 35-3P1	35	50,-
CP 40-3P1	40	50,-
CP 50-3P1	50	50,-

Model	Nominal load	Price excl. of VAT ex works €
KERN	kg	
CP 50-3P3	50	65,-
CP 75-3P3	75	65,-

Model	Nominal load	Price excl. of VAT ex works €
KERN	kg	
ECO design (without EC type approval)		
CP 300-0Y4 <small>NEW</small>	0,3	45,-
CP 1500-0Y4 <small>NEW</small>	1,5	45,-
CP 3000-0Y4 <small>NEW</small>	3	45,-

NEW New model

Model	Nominal load	Price excl. of VAT ex works €
KERN	kg	
ECO design (without EC type approval)		
CP 3-2Y1 <small>NEW</small>	3	30,-
CP 5-2Y1 <small>NEW</small>	5	30,-
CP 10-2Y1 <small>NEW</small>	10	30,-
CP 15-2Y1 <small>NEW</small>	15	30,-
CP 20-2Y1 <small>NEW</small>	20	30,-
CP 30-2Y1 <small>NEW</small>	30	30,-

NEW New model

13

! Tip Further details and technical data sheet as well as extensive accessories can be found at www.kern-sohn.com

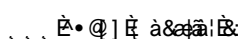



CK P1

CK P2



CK P3

CK P4

CP P2

Single-point load cells of aluminium

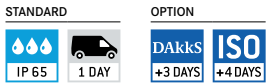

- Accuracy in accordance with OIML R60 C3
- Dust and spray protection to IP65 (in accordance with EN 60529)
- Aluminium, anodised
- Suitable for price-computing scales, bench scales, etc.
- Maximum platform size 100–300 kg: 400×400 mm
- Maximum platform size 400–500 kg: 450×450 mm
- Nominal sensitivity: 2 mV/V
- Note: Version in accordance with OIML R60 C4 or C5 on request

CP P9

Single-point load cells of stainless steel



- Accuracy in accordance with OIML R60 C3
- Dust and spray protection to IP68/IP69K (in accordance with EN 60529), welded to create a hermetic seal
- Stainless steel
- Area of application: Measuring mass as well as compressive force in harsh environments
- Suitable for platform scales, checkweighers
- Maximum platform size 10–50 kg: 400×400 mm
- Maximum platform size 100–500 kg: 800×800 mm
- 4-wire connection (10–50 kg)
- 6-wire connection (100–500 kg)
- Nominal sensitivity: 2 mV/V
- Note: Version in accordance with OIML R60 C4 or C5 on request

CK P1-4

Miniature load cells made of aluminium



- Dust and spray protection to IP65 (in accordance with EN 60529)
- Aluminium
- High level of accuracy
- Suitable for small scales and kitchen scales and force-measuring devices
- 4-wire connection

Model	Nominal load	Price
KERN	kg	excl. of VAT ex works €
CP 100-3P2	100	75,-
CP 150-3P2	150	75,-
CP 200-3P2	200	75,-
CP 300-3P2	300	75,-
CP 400-3P2	400	75,-
CP 500-3P2	500	75,-

Model	Nominal load	Price
KERN	kg	excl. of VAT ex works €
CP 10-3P9	10	350,-
CP 20-3P9	20	350,-
CP 50-3P9	50	350,-
CP 100-3P9	100	520,-
CP 200-3P9	200	520,-
CP 300-3P9	300	520,-
CP 400-3P9	400	520,-
CP 500-3P9	500	520,-

Model	Nominal load	Price
KERN	kg	excl. of VAT ex works €
CK 600-0P1	0,6	27,-
CK 1-0P1	1	27,-
CK 2-0P1	2	27,-
CK 3-0P1	3	28,-
CK 5-0P1	5	27,-
CK 6-0P1	6	27,-
CK 300-0P2	0,3	41,-
CK 600-0P2	0,6	41,-
CK 1000-0P3	1	24,-
CK 100-0P4	0,1	35,-
CK 120-0P4	0,12	35,-
CK 300-0P4	0,3	35,-
CK 500-0P4	0,5	35,-

! Tip Further details and technical data sheet as well as extensive accessories can be found at www.kern-sohn.com



Fig. shows accessories, base plate 1 SAUTER CE Q30903 and bearings 2 SAUTER CE Q30904, for further accessories please visit our online shop



Fig. shows optional accessory load corner 3 SAUTER CE P4022

CB Q1 · CB Q2

Bending beam measuring cells made from stainless steel



- Accuracy in accordance with OIML R60 C3
- CE and RoHS compliant
- Dust and spray protection to IP68/IP69K (in accordance with EN 60529), welded to create a hermetic seal
- Stainless steel
- Area of application: Measuring mass as well as compressive force in harsh environments
- Suitable for platform scales, weigh hoppers, floor scales and other weighing devices
- 4-wire connection
- Nominal sensitivity: 2 mV/V
- Note: Accuracy class OIML R60 C6 or EX version on request

CB P1

Bending beam made from stainless steel



- Accuracy in accordance with OIML R60 C3
- CE and RoHS compliant
- Dust and spray protection to IP67 (in accordance with EN 60529), hermetically encapsulated
- Nickel-plated steel
- Area of application: Measuring mass as well as compressive force in harsh environments
- Suitable for platform scales, silo scales, bed scales and other diverse scales
- 4-wire connection
- Nominal sensitivity: 3 mV/V

Accessories CB Q1 · CB Q2:

- Traction device, steel, galvanised, suitable for CB Q1, SAUTER CE Q30901, € 75,-
- Traction device, steel, rustproof, suitable for CB Q2, SAUTER CE Q34905, € 80,-
- 1 Base plate, steel, galvanised, suitable for CB Q1, SAUTER CE Q30903, € 90,-
- Base plate, steel, rustproof, suitable for CB Q1, SAUTER CE RQ30903, € 175,-
- Base plate, steel, rustproof, suitable for CB Q2, SAUTER CE Q34903, € 85,-
- 2 Bearing, steel, rustproof, suitable for CB Q1 (nominal load 5 kg–50 kg), SAUTER CE Q30904, € 105,-
- Bearing, steel, rustproof, suitable for CB Q1 (nominal load 75 kg–300 kg), SAUTER CE Q30905, € 105,-
- Bearing, steel, rustproof, suitable for CB 500-3Q1, SAUTER CE Q30906, € 180,-
- Bearing, steel, rustproof, suitable for CB 750-3Q2, CB 1000-3Q2, CB 1500-3Q2, SAUTER CE Q34906, € 165,-
- Load corner, steel, galvanised, suitable for CB Q1, SAUTER CE Q30907, € 195,-
- Load corner, steel, rustproof, suitable for CB Q1, SAUTER CE RQ30907, € 280,-
- Adjustable foot, steel, rustproof, suitable for SAUTER CE Q34901, € 60,-

13

Model	Nominal load	Price excl. of VAT ex works €
KERN	kg	
CB 5-3Q1	5	185,-
CB 10-3Q1	10	185,-
CB 20-3Q1	20	185,-
CB 30-3Q1	30	185,-
CB 50-3Q1	50	185,-
CB 75-3Q1	75	185,-
CB 100-3Q1	100	185,-
CB 150-3Q1	150	185,-
CB 200-3Q1	200	185,-
CB 250-3Q1	250	185,-
CB 300-3Q1	300	185,-
CB 500-3Q1	500	185,-
CB 750-3Q2	750	195,-
CB 1000-3Q2	1000	195,-
CB 1500-3Q2	1500	195,-

* up to max. 500 kg

Model	Nominal load	Price excl. of VAT ex works €
KERN	kg	
CB 100-3P1	100	100,-
CB 250-3P1	250	100,-

Accessories CB P1:

- Adjustable foot, steel, nickel-plated, load base M12 for CT 500-3P1, CT 1000-3P1 and CT 1500-3P1, SAUTER CE P2012, € 22,-
- 3 Load corner, steel, nickel-plated for CT 500-3P1, CT 1000-3P1 and CT 1500-3P1, SAUTER CE P4022, € 115,-
- Spacer plates for bending beam CB P1 made from steel, SAUTER CE P3012, € 8,-

! Tip Further details and technical data sheet as well as extensive accessories can be found at www.kern-sohn.com



Fig. shows optional accessory load corner 1 SAUTER CE RQ35903



Fig. shows optional accessory load corner 2 SAUTER CE P4022

CT Q1

Shear beam made from stainless steel

STANDARD

IP 68 IP 69K 1 DAY

OPTION

DAkKS ISO +3 DAYS +4 DAYS

- Accuracy in accordance with OIML R60 C3
- CE and RoHS compliant
- Dust and spray protection to IP68/IP69K (in accordance with EN 60529), welded to create a hermetic seal
- Stainless steel
- Area of application: Measuring mass as well as compressive force in harsh environments
- Suitable for platform scales, weigh hoppers, flush-mounted floor scales and other weighing devices
- 6-wire connection
- Nominal sensitivity: 2 mV/V
- Note: EX version on request

CT P1 · CT P2

Shear beam made from stainless steel

STANDARD

IP 67 M 1 DAY

OPTION

DAkKS ISO +3 DAYS +4 DAYS

- Accuracy in accordance with OIML R60 C3
- CE and RoHS compliant
- Dust and spray protection to IP67 (in accordance with EN 60529), welded to create a hermetic seal
- Nickel-plated steel
- Area of application: Measuring mass as well as compressive force in harsh environments
- Suitable for platform scales, weigh hoppers, flush-mounted floor scales and other weighing devices
- 4-wire connection
- Nominal sensitivity: 3 mV/V
- Note: EX version, 6-wire connection and accuracy class C4 or C5 on request
- **CT P2:** Delivery with calibrated characteristic value, if several cells are ordered

Accessories CT Q1:

- Base plate, steel, rustproof, suitable for CT Q1, SAUTER CE RQ35911, € 185,-
- Base plate, steel, rustproof, suitable for CT 3000-3Q1, CT 5000-3Q1, SAUTER CE RQ35912, € 185,-
- Base plate, steel, rustproof, suitable for CT 7500-3Q1, CT 10000-3Q1, SAUTER CE RQ35919, € 780,-
- Bearing, steel, rustproof, suitable for CT Q1, SAUTER CE RQ35909, € 135,-
- Bearing, steel, rustproof, suitable for CT 3000-3Q1, CT 5000-3Q1, SAUTER CE RQ35910, € 270,-
- Bearing, steel, rustproof, suitable for CT 7500-3Q1, CT 10000-3Q1, SAUTER CE RQ35918, € 350,-
- Load corner, steel, rustproof, suitable for CT Q1, SAUTER CE RQ35902, € 350,-
- 1 Load corner, steel, rustproof, suitable for CT 3000-3Q1, CT 5000-3Q1, SAUTER CE RQ35903, € 515,-

Accessories CT P1:

- Load corner, steel, rustproof, suitable for CT 10000-3P1, CT 10000-3P2, SAUTER CE P40210, € 395,-
- 2 Load corner, steel, nickel-plated, suitable for CT 500-3P1, CT 1000-3P1, CT 1500-3P1, SAUTER CE P4022, € 115,-
- Load corner, steel, nickel-plated, suitable for CT 2500-3P1, CT 3000-3P1, CT 5000-3P1, SAUTER CE P4025, € 200,-
- Adjustable foot, steel, rustproof, suitable for CT 500-3P1, CT 1000-3P1, CT 1500-3P1, SAUTER CE P2012, € 22,-
- Adjustable foot, steel, rustproof, suitable for CT 2500-3P1, CT 3000-3P1, CT 5000-3P1, SAUTER CE P2018, € 29,-
- Adjustable foot, steel, rustproof, suitable for CT 10000-3P1, SAUTER CE P2024, € 85,-
- Spacer plate for CT 500-3P1, CT 500-3P2, CT 1000-3P1, CT 1000-3P2 and CT 1500-3P1, SAUTER CE P3012, € 8,-
- Spacer plate for CT 2500-3P1, CT 3000-3P1, CT 3000-3P2, CT 5000-3P1 and CT 5000-3P2 SAUTER CE P3015, € 8,-
- Spacer plate for CT 10000-3P1 and CT 10000-3P2 SAUTER CE P30110, € 8,-

Model	Nominal load	Price
KERN	kg	excl. of VAT ex works €
CT 300-3Q1	300	180,-
CT 500-3Q1	500	180,-
CT 750-3Q1	750	180,-
CT 1000-3Q1	1000	180,-
CT 1500-3Q1	1500	180,-
CT 2000-3Q1	2000	180,-
CT 3000-3Q1	3000	350,-
CT 5000-3Q1	5000	350,-
CT 7500-3Q1	7500	450,-
CT 10000-3Q1	10000	450,-

* up to max. 500 kg
** up to max. 12 t

Model	Nominal load	Price
KERN	kg	excl. of VAT ex works €
CT 500-3P1	500	90,-
CT 1000-3P1	1000	90,-
CT 1500-3P1	1500	90,-
CT 2500-3P1	2500	110,-
CT 3000-3P1	3000	110,-
CT 5000-3P1	5000	110,-
CT 10000-3P1	10000	160,-
CT 500-3P2	500	95,-
CT 1000-3P2	1000	95,-
CT 3000-3P2	3000	115,-
CT 5000-3P2	5000	115,-
CT 10000-3P2	10000	165,-

* up to max. 500 kg
** up to max. 12 t

! Tip Further details and technical data sheet as well as extensive accessories can be found at www.kern-sohn.com

NEW

NEW



CJ P4



CJ X467



CJ X468



CJ P6



CJ P4PG

CJ P

Junctionbox CJ P for connecting several measuring cells to one evaluation unit

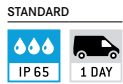

- Prepared for 4-wire and 6-wire measuring cells
- Models available for 2, 4, 6 or 8 load cells
- Robust aluminium die-cast housing
- Protection against dust and spray

CJ X

Junctionbox for connecting several measuring cells to one evaluation unit

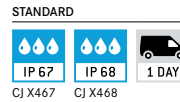

- Prepared for 4-wire and 6-wire measuring cells
- Models available for 2, 4, 6 or 8 load cells
- Robust aluminium die-cast housing

CJ X467:

- Stainless steel with protection against dust and water splashes IP67

CJ X468:

- Aluminium with protection against dust and water splashes IP68

13

Model	Number of connections	Price excl. of VAT ex works €
KERN		
CJ P2	2	75,-
CJ P4	4	75,-
CJ P4PG	4	80,-
CJ P6	6	95,-
CJ P8	8	95,-

Model	Number of connections	Price excl. of VAT ex works €
KERN		
CJ X467	4	190,-
CJ X468	4	110,-

! Tip Further details and technical data sheet as well as extensive accessories can be found at www.kern-sohn.com

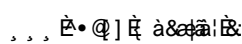

Pallet truck scales

Weighing and transporting – just one operation

Speed up your warehouse and dispatch processes with the KERN pallet truck scales.

Get the exact weight of a load and at the same time, transport it to a specific location, all in one operation. This reduces commissioning times and avoids queues in front of fixed floor scales.

These mobile weighing solutions are space-saving and deliver reliable weighing results. Differences between given and actual weights can be determined quickly e.g. in the goods-in and out department. This uncovers inaccurate quantities, saves time and money and therefore ensures a very short amortisation period of the scales original cost.

KERN pallet truck scales are of robust industrial quality, with high-level protection against dust and water splashes, with high-contrast, easy-to-read displays as well as solid wheels and load rollers – all this helps to give you practical support in your work – day after day.

Of course, all KERN pallet truck scales can also be calibrated and delivered with a DAkkS calibration certificate (optional). This ensures the high level of accuracy of your pallet truck scale.

Quick-Finder Pallet truck scales										
Readability [d] kg	Weighing capacity [Max] kg	Model KERN	Price excl. of VAT ex works €	Page	DAYS	CAL EXT	SUM	IP	BATT	ACCU
					For an explanation on the pictos, see front flap					
1	2000	VHB 2T1	1320,-	152	2	●	●	●	●	○

● = standard ○ = option

KERN VHB

Page 152

- The power pack in the dispatch department and the warehouse
- The display device is well-protected by a metal frame
- Optimised load rollers so that you can get over rough ground more easily and greater manoeuvrability



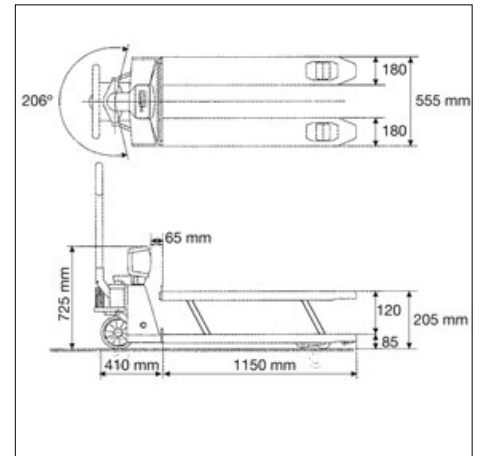

Pallet truck scale with complete protection against dust and water splashes IP65/67 and a memory for a container weight

Features

- PRE-TARE function for manual subtraction of a known container weight, useful for checking fill-levels
- **1** Display device: plastic, protection against dust and water splashes IP65
- **2** Load fork: Protection against dust and water splashes IP67, temporary use in wet areas possible
- Pivot range 206°
- Castors: Solid rubber on aluminium rims
- **3** Load rollers: Tandem tyres to overcome thresholds and obstacles more easily
- Totalising of weights
- Ready for use: Batteries included, 4×1.5 V AA, operating time up to 80 h

Technical data

- Large LCD display, digit height 28 mm
- Permissible ambient temperature -10 °C/40 °C

Accessories

- Castors made of red polyurethane on aluminium rims. Ideal for light-coloured flooring as they leave less visible abrasive marks. Suitable for the current models of the pallet truck scale range KERN VHB (when retrofitting, please give the serial number of the pallet truck scale available when ordering), scope of delivery: 1 item, KERN VHB-A02, € 160,-

1 Shipment via freight forwarder. Please ask for dimensions, gross weight, shipping

STANDARD

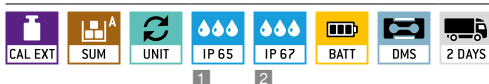

OPTION



Model	Weighing capacity	Readability	Net weight	Price excl. of VAT ex works €	Option	
					DAKKS KERN	DAKKS Calibr. Certificate €
KERN VHB 2T1	[Max] kg 2000	[d] kg 1	approx. kg 110	1320,-	963-131	220,-

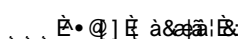

Hanging scales/Crane scales

TÜV-tested safety

KERN puts great emphasis on safety. For your safety, all KERN hanging and crane scales are subject to a stringent load test in accordance with EN 13155 and (Non-fixed load lifting attachments/breakage resistance) and EN 61010-1 (Electrical safety).

As well as the classic crane scales, we also have electronic tensile dynamometers which are extremely versatile thanks to their stable, compact construction. They can, for example, be fitted into testing machines, used for checking for overload, for bracing and tensile force measurement, etc.

This type of device is ideally suited for use between shackles or with a test bench. This is where the benefit of this construction comes to the fore, as the tensile force can be applied in both directions. These compact crane scales are also particularly suitable when weighing suspended loads where space is tight.

At the core of this construction is a robust load cell. Through the absence of moving parts, these scales are practical in maintenance and wear free.

! Note

DAkkS calibration and conformity evaluation for crane scales up to 12 t



Do you use your crane scales in ISO-certified processes or where verification is mandatory? Then we can produce the right calibration certificate or the relevant Declaration of Conformity for your measuring device. Thanks to a modern crane scale test unit, we can calibrate or verify crane scales and force-measuring devices from any manufacturer to a maximum load of up to 12 t or 120 kN. You can find all the important details on pages 214, 219 or directly from one of our test service specialists, we will be pleased to help you.

KERN HFD

Page 165

- o **Triple-range scale: Ideal, when high maximum loads need to be weighed, but in the lower load range you still need high resolution. This means that three balances can be replaced with one – which saves space and money!**
- o **Also available with high protection type IP67!**
- o **Also EC type approval as version with calibration approval !**



from €
370,-

Quick-Finder Hanging scales/Crane scales

Readability [d] kg	Weighing capacity [Max] kg	Model KERN	Price excl. of VAT ex works €	Page	For an explanation on the pictos, see front flap									
					0,005	5	HDB 5K5N	60,-	157	1			●	
0,005	6	HDB 6K-3XL	85,-	158	1			●		●		●		
0,01	10	HDB 10K10N	60,-	157	1			●		●		●		
0,01	15	HDB 10K-2XL	85,-	158	1			●		●		●		
0,01	20	HCB 20K10	105,-	159	1			●		●		●		
0,01	50	HGA 50K-2S05	80,-*	155	1			●		●		●		
0,02	15	CH 15K20	69,-	156	1			●		●		●		
0,02	30	HDB 30K-2XL	85,-	158	1			●		●		●		
0,02	50	HCB 50K20	115,-	159	1			●	●	●		●		
0,02	60	HCD 60K-2	195,-	161	1			●		●		●	●	
0,02 0,05	60 150	HCD 100K-2D	205,-	161	1			●		●		●	●	
0,05	50	CH 50K50	75,-	156	1			●		●		●		
0,05	99	HCB 99K50	100,-	159	1			●		●		●		
0,05	150	HCD 100K-2	195,-	161	1			●		●		●	●	
0,05	150	HFB 150K50	345,-	164	1			●		●		●	●	
0,05 0,1	150 300	HCD 300K-2D	205,-	161	1			●		●		●	●	
0,05 0,1 0,2	150 300 600	HFD 600K-1	370,-	165	1			●		●		●	●	
0,05 0,1 0,2	150 300 600	HFD 600K-1IP	570,-	165	1			●		●		●	●	
0,1	50	CH 50K100	65,-	156	1			●		●		●		
0,1	50	HCB 50K100	90,-	159	1			●		●		●		
0,1	50	HCB 50K100IP	130,-	160	1			●		●		●		
0,1	200	HCB 200K100	115,-	159	1			●		●		●		
0,1	300	HCD 300K-1	195,-	161	1			●		●		●	●	
0,1	300	HFB 300K100	375,-	164	1			●		●		●	●	
0,1	1000	HFM 1T0.1	690,-	167	1			●		●		●	●	
0,1 0,2 0,5	300 600 1500	HFD 1T-4	380,-	165	1			●		●		●	●	
0,1 0,2 0,5	300 600 1500	HFD 1T-4IP	580,-	165	1			●		●		●	●	
0,2	100	HCB 100K200	99,-	159	1			●		●		●		
0,2	100	HCB 100K200IP	130,-	160	1			●		●		●		
0,2	600	HFA 600K-1	560,-	163	1			●		●		●	●	
0,2	600	HFC 600K-1	890,-	163	1			●		●		●	●	
0,2	600	HFB 600K200	375,-	164	1			●		●		●	●	
0,2	600	HFD 600K-1M	480,-	165	1	○		●		●		●	●	
0,2 0,5 1	600 1500 3000	HFD 3T-3	590,-	165	1			●		●		●	●	
0,2 0,5 1	600 1500 3000	HFD 3T-3IP	790,-	165	1			●		●		●	●	
0,5	200	HCB 200K500	95,-	159	1			●		●		●		
0,5	200	HCB 200K500IP	130,-	160	1			●		●		●		
0,5	1000	HFA 1T-4	580,-	163	1			●		●		●	●	
0,5	1000	HFC 1T-4	890,-	163	1			●		●		●	●	
0,5	1500	HFD 1T-4M	480,-	165	1	○		●		●		●	●	
0,5	1500	HFO 1.5T0.5M	1030,-	168	1	○		●		●		●	●	
0,5	3000	HFM 3T0.5	710,-	167	1			●		●		●	●	
0,5	5000	HFM 5T0.5	930,-	167	1			●		●		●	●	
0,5 1 2	1500 3000 6000	HFD 6T-3	640,-	165	1			●		●		●	●	
0,5 1 2	1500 3000 6000	HFD 6T-3IP	840,-	165	1			●		●		●	●	
1	500	HCB 0.5T-3	190,-	159	1			●		●		●		
1	3000	HFA 3T-3	630,-	163	1			●		●		●	●	
1	3000	HFC 3T-3	950,-	163	1			●		●		●	●	
1	3000	HFD 3T-3M	640,-	165	1	○		●		●		●	●	
1	3000	HFO 3T1M	1130,-	168	1	○		●		●		●	●	
1	10000	HFM 10T1	1260,-	167	2**			●		●		●	●	
1 2 5	3000 6000 12000	HFD 10T-3	760,-	165	1			●		●		●	●	
1 2 5	3000 6000 12000	HFD 10T-3IP	960,-	165	1			●		●		●	●	
2	1000	HCB 1T-3	250,-	159	1			●		●		●		
2	5000	HFA 5T-3	690,-	163	1			●		●		●	●	
2	5000	HFC 5T-3	1020,-	163	1			●		●		●	●	
2	6000	HFD 6T-3M	790,-	165	1	○		●		●		●	●	
2	6000	HFO 6T2M	1400,-	168	2**	○		●		●		●	●	
5	10000	HFA 10T-3	1090,-	163	1			●		●		●	●	
5	10000	HFC 10T-3	1410,-	163	1			●		●		●	●	
5	12000	HFD 10T-3M	900,-	165	1	○		●		●		●	●	

* Price set of 5 units

** Shipment via freight forwarder. Please ask for dimensions, gross weight, shipping costs

● = standard ○ = option

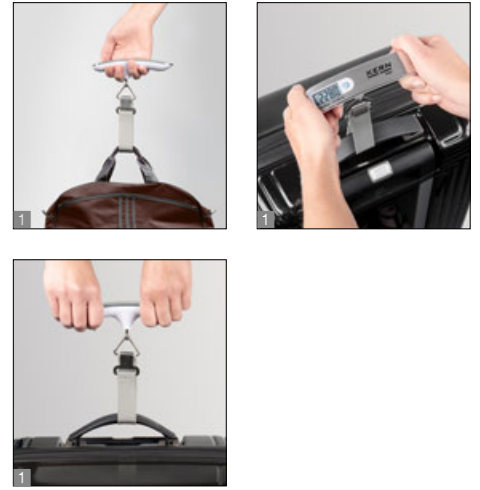

Ultra compact, digital luggage scale for fast weighing of luggage and other suspended loads

Features

- This ergonomically-optimised luggage scale is perfectly suited for rapid, accurate checking of cases, bags, sports baggage, etc. The high maximum load means that there is sufficient safety reserve and can therefore also be used for weighing other, suspended loads
- Ergonomic design for easy handling
- Robust nylon fabric tape for secure fixing of the item to be weighed
- Simple and convenient 1-key operation
- Easy to toggle between units at the press of a button
- High mobility: thanks to battery operation, compact, lightweight construction, it is suitable for the use in several locations
- Automatic Hold function: When the weighing value remains unchanged the weight indicated on the display is automatically "frozen" for 10 sec. This leaves sufficient time to read the weight in peace

Technical data

- LCD display, digit height 9 mm
- Ready for use: Batteries included, 3V CR2032, operating time up to 20 h, AUTO-OFF function to preserve the battery, Battery level indicator on display
- Note: The models are only delivered in a set of 5 units. i.e. the price given in the table refers to a delivery of 5 items. Cannot be delivered individually. The calibration prices given here refer to calibration of a single balance

STANDARD				OPTION
UNIT	BATT	DMS	1 DAY	DAkKS
				+3 DAYS

Model	Weighing capacity [Max] kg	Readability [d] g	Dimensions housing W×D×H mm	Net weight/ balance approx. kg	Quantity delivered (balances)	Price excl. of VAT ex works €	Option		Quantity delivered (DAkKS Calibr. Certificate)
							DAkKS Calibr. Certificate	€	
KERN HGA 50K-2S05	50	10	150×31×35	0,4	5	80,-*	963-128H	94,-	1

* Price set of 5 units

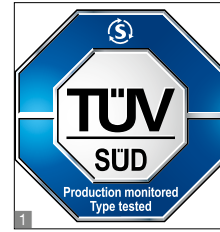

The classic among manual hanging scales – perfect for rapid weighing of higher loads

Features

- With the TÜV certification mark, the scales meet the requirements of the standard EN 13155 (Non-fixed load lifting attachments/ Breakage resistance) and EN 61010-1 (Electrical safety)
- Ideal for rapid control in goods-in and goods-out
- Also essential in the private sector to determine the weight of fish, game, fruits, bicycle parts, suitcases etc.
- Hold function: For easy reading of the weighing result, the display can be “frozen” in different ways. Either automatically when the weighing value remains unchanged or manually by pressing the Hold key
- Peak load display (peak hold)
- Hook, steel

Technical data

- LCD display, digit height 11 mm
- Tape measure, extractable, length approx. 100 cm
- Ready for use: Batteries included, 9 V block, operating time up to 20 h
- Further weighing units: kg, lb, N
- Permissible ambient temperature 5 °C/35 °C

Accessories

- Tare pan with pan beam, details see Accessories, KERN CH-A01N, **€ 70,-**

STANDARD OPTION

CAL EXT	UNIT	MOVE	BATT	DMS	1 DAY	DAkkS +3 DAYS

Model	Weighing capacity [Max] kg	Readability [d] g	Dimensions housing W×D×H mm	Net weight approx. kg	Price excl. of VAT ex works €	Option	
						DAkkS KERN	DAkkS Calibr. Certificate €
CH 15K20	15	20	90×30×176,5	0,35	69,-	963-128H	94,-
CH 50K50	50	50	90×30×176,5	0,35	75,-	963-128H	94,-
CH 50K100	50	100	90×30×176,5	0,35	65,-	963-128H	94,-

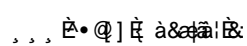

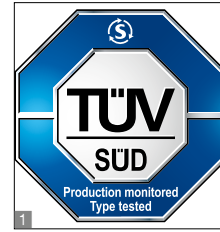

Practical hanging scale for rapid, mobile weighing

Features

- **1** With the TÜV certification mark, the scales meet the requirements of the standard EN 13155 (Non-fixed load lifting attachments/ breakage resistance) and EN 61010-1 (Electrical safety)
- Ideal for rapid control in goods-in and goods-out
- Also essential in the private sector to determine the weight of fish, game, fruits, bicycle parts, suitcases etc.
- Hold function: For easy reading of the weighing result, the display can be “frozen” in different ways. Either automatically when the weighing value remains unchanged or manually by pressing the Hold key
- Hook, steel, can be hinged
- Peak load display (peak hold)

Technical data

- LCD display, digit height 12 mm
- Ready for use: Batteries included, 2x1.5 V AAA, operating time up to 180 h
- Further weighing units: kg, lb, N
- Permissible ambient temperature 5 °C/35 °C

Accessories

- **2** Tare pan with pan beam, details see Accessories, KERN CH-A01N, **€ 70,-**

STANDARD						OPTION

Model	Weighing capacity [Max] kg	Readability [d] g	Dimensions housing W×D×H mm	Net weight approx. kg	Price excl. of VAT ex works €	Option DAkkS Calibr. Certificate	
						DAkkS KERN	€
HDB 5K5N	5	5	72×25×105	0,20	60,-	963-127H	78,-
HDB 10K10N	10	10	72×25×105	0,20	60,-	963-128H	94,-

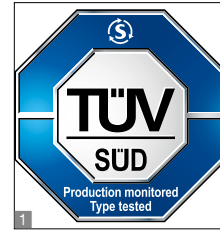

User-friendly hanging scale for rapid, mobile weighing

Features

- The larger design creates space for a large handle, which enables even better handling especially with heavier loads
- **1** With the TÜV certification mark, the scales meet the requirements of the standard EN 13155 (Non-fixed load lifting attachments/ Breakage resistance) and EN 61010-1 (Electrical safety)
- Ideal for rapid control in goods-in and goods-out
- Also essential in the private sector to determine the weight of fish, game, fruits, bicycle parts, suitcases etc.
- Hold function: For easy reading of the weighing result, the display can be “frozen” in different ways. Either automatically when the weighing value remains unchanged or manually by pressing the Hold key
- Peak load display (peak hold)
- Hook, steel, can be hinged

Technical data

- LCD display, digit height 12 mm
- Ready for use: Batteries included, 2×1.5 V AAA, operating time up to 180 h
- Further weighing units: kg, lb, N
- Permissible ambient temperature 5 °C/35 °C

Accessories

- **2** Tare pan with pan beam, details see Accessories, KERN CH-A01N, **€ 70,-**

STANDARD						OPTION	

Model	Weighing capacity [Max] kg	Readability [d] g	Dimensions housing W×D×H mm	Net weight approx. kg	Price excl. of VAT ex works €	Option	
						DAkkS KERN	DAkkS Calibr. Certificate €
HDB 6K-3XL	6	5	107×25×101	0,20	85,-	963-128H	94,-
HDB 10K-2XL	15	10	107×25×101	0,20	85,-	963-128H	94,-
HDB 30K-2XL	30	20	107×25×101	0,20	85,-	963-128H	94,-



Handy hanging scale for higher loads

Features

- **1** With the TÜV certification mark, the scales meet the requirements of the standard EN 13155 (Non-fixed load lifting attachments/ breakage resistance) and EN 61010-1 (Electrical safety)
- Ideal for rapid control in goods-in and goods-out
- Also essential in the private sector to determine the weight of fish, game, fruits, bicycle parts, suitcases etc.
- Hold function: For easy reading of the weighing result, the display can be “frozen” in different ways. Either automatically when the weighing value remains unchanged or manually by pressing the Hold key
- Peak load display (peak hold), Measuring frequency 5 Hz [Max] ≤ 200 kg: Snap link (stainless steel) with safety catch, as standard [Max] ≤ 200 kg: Hook (stainless steel) with safety catch
- **2** [Max] ≥ 0,5 t: Reinforced version for heavy loads. Snap link and Hook not included

Technical data

- LCD display, digit height 12 mm
- Hole diameter of load support, model with [Max] ≤ 200 kg: approx. 14 mm [Max] > 200 kg: approx. 16 mm
- Ready for use: Batteries included, 3×1.5 V AA, operating time up to 300 h

Accessories

for models with [Max] ≤ 20 kg

- Tare pan with pan beam, details see Accessories, KERN CH-A01N, € 70,-

for models with [Max] ≥ 100 kg

- **3** Hook with safety catch, cast steel, galvanised and lacquered, revolving. Scope of delivery: 2 shackles, 1 lacquered screw bolt, 1 hook, KERN YHA-06, € 125,-

for models with [Max] ≤ 200 kg

- Snap link (stainless steel) with safety catch, standard, opening approx. 15 mm, KERN HCB-A01, € 33,-
- Hook (stainless steel), standard, opening approx. 25 mm, KERN HCB-A02, € 30,-

for models with [Max] ≥ 0,5 t

- **4** High-strength shackle, hot-dipped galvanised cast steel bracket, bow shaped. Scope of delivery: 2 shackles with lacquered screw bolts, suitable for models KERN HCB with [Max] ≥ 0,5 t, KERN YSC-03, € 50,-

STANDARD OPTION

CAL EXT	UNIT	MOVE	BATT	DMS	1 DAY	DAkkS +3 DAYS

Model	Weighing capacity [Max] kg	Readability [d] g	Dimensions housing W×D×H mm	Net weight approx. kg	Price excl. of VAT ex works €	Option	
						DAkkS KERN	DAkkS Calibr. Certificate €
KERN							
HCB 20K10	20	10	82×43×153	0,30	105,-	963-128H	94,-
HCB 50K20	50	20	82×43×153	0,30	115,-	963-128H	94,-
HCB 50K100	50	100	82×43×153	0,30	90,-	963-128H	94,-
HCB 99K50	99	50	82×43×153	0,30	100,-	963-129H	110,-
HCB 100K200	100	200	82×43×153	0,30	99,-	963-129H	110,-
HCB 200K100	200	100	82×43×153	0,30	115,-	963-129H	110,-
HCB 200K500	200	500	82×43×153	0,30	95,-	963-129H	110,-
HCB 0.5T-3	500	1000	82×43×153	0,40	190,-	963-130H	200,-
HCB 1T-3	1000	2000	82×43×153	0,40	250,-	963-130H	200,-

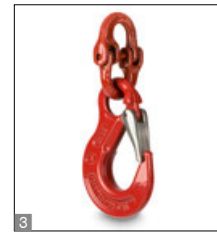

Robust, compact hanging scale with high level of protection against dust and water spray

Features

- **1** With the TÜV certification mark, the scales meet the requirements of the standard EN 13155 (Non-fixed load lifting attachments/ Breakage resistance) and EN 61010-1 (Electrical safety)
- Housing stainless Steel, IP65-protected against dust and water splashes
- Ideal for rapid control in goods-in and goods-out
- Also essential in the private sector to determine the weight of fish, game, fruits, bicycle parts, suitcases etc.
- Hold function: For easy reading of the weighing result, the display can be “frozen” in different ways. Either automatically when the weighing value remains unchanged or manually by pressing the Hold key
- Peak load display (peak hold), Measuring frequency 5 Hz
- Snap link (stainless steel) with safety catch, as standard
- Hook (stainless steel) as standard

Technical data

- LCD display, digit height 12 mm
- Hole diameter of load support, model with [Max] ≤ 200 kg: approx. 14 mm [Max] > 200 kg: approx. 16 mm
- **2** Second display on the rear of the balance
- Ready for use: Batteries included, 2x1.5 V AA, operating time up to 200 h

Accessories

for models with [Max] ≥ 100 kg

- **3** Hook with safety catch, cast steel, galvanised and lacquered, revolving. Scope of delivery: 2 shackles, 1 lacquered screw bolt, 1 hook, KERN YHA-06, **€ 125,-**
- Snap link (stainless steel) with safety catch, standard, opening approx. 15 mm, KERN HCB-A01, **€ 33,-**
- Hook (stainless steel), opening approx. 25 mm, KERN HCB-A02, **€ 30,-**

STANDARD							OPTION	
CAL EXT	UNIT	MOVE	IP 65	BATT	DMS	1 DAY	DAKKS	+3 DAYS

Model	Weighing capacity [Max] kg	Readability [d] g	Dimensions housing W×D×H mm	Net weight approx. kg	Price excl. of VAT ex works €	Option	
						DAKKS Calibr. Certificate	
						DAKKS KERN	€
HCN 50K100IP	50	100	96×48×179	0,50	130,-	963-128H	94,-
HCN 100K200IP	100	200	96×48×179	0,50	130,-	963-129H	110,-
HCN 200K500IP	200	500	96×48×179	0,50	130,-	963-129H	110,-

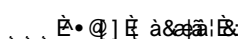

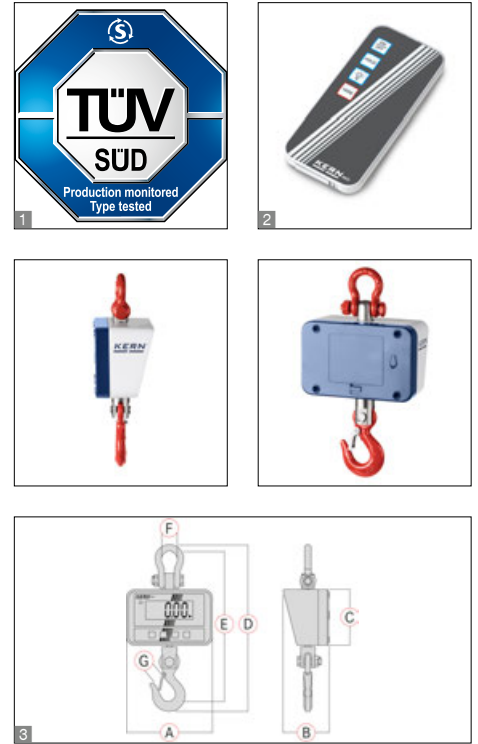

High-resolution crane scale for loads up to 300 kg

Features

- Fully-equipped crane scale for low to medium load ranges. The solid design guarantees that extra level of safety (TÜV tested). Thanks to the large LCD display and the remote control which is delivered as standard, it can also be operated safely from a distance and results can be read off
- With the TÜV certification mark, the scale meets the requirements of the standard EN 13155 (Non-fixed load lifting attachments/ Breakage resistance) and EN 61010-1 (Electrical safety)
- High level of mobility: thanks to battery pack operation, compact construction and low weight, it is suitable for use in several locations (production, warehouse, dispatch department, etc.)
- Hold function: For easy reading of the weighing result, the display can be “frozen” in different ways. Either automatically when the weighing value remains unchanged or manually by pressing the Hold key

- Tare: Resets the display to “0” when there is a load on the scale. Now removed or added loads are directly displayed
- Battery level indicator, LED visual display
- Large high-contrast display that is easy to read
- Standby function: display automatically switched off after 5 min without a change of load. Automatic activation with the touch of a key
- Hook with safety catch, revolving
- Shackle and safety catch made of nickel-plated steel
- Infrared remote control standard. Range up to 20 m. All functions can be selected. W×D×H 65×24×100 mm. Batteries included

Technical data

- Backlit LCD display digit height 28 mm
- Ready for use: Batteries included, 4×1.5 V AA, operating time up to 100 h
- Precision: 0,2 % of [Max]
- Permissible ambient temperature 5 °C/40 °C

Accessories

- Internal rechargeable battery pack for Load lifting attachments, operating time up to 50 h without backlight, charging time approx. 12 h, KERN HCD-A01, € 50,-

STANDARD					OPTION	
CAL EXT	UNIT	BATT	DMS	1 DAY	ACCU	DAKkS +3 DAYS

Model	Weighing capacity [Max] kg	Readability [d] g	Net weight approx. kg	③ Dimensions							Price excl. of VAT ex works €	Option	
				A mm	B mm	C mm	D mm	E mm	F mm	G mm		DAKkS KERN	Calibr. Certificate €
KERN HCD 60K-2	60	20	1,10	150	79	97	276	250	26	18	195,-	963-129H	110,-
KERN HCD 100K-2	150	50	1,10	150	79	97	276	250	26	18	195,-	963-129H	110,-
KERN HCD 300K-1	300	100	1,10	150	79	97	276	250	26	18	195,-	963-129H	110,-
Dual-range balance switches automatically to the next largest weighing capacity [Max] and readability [d]													
KERN HCD 100K-2D	60 150	20 50	1,10	150	79	97	276	250	26	18	205,-	963-129H	110,-
KERN HCD 300K-2D	150 300	50 100	1,10	150	79	97	276	250	26	18	205,-	963-129H	110,-

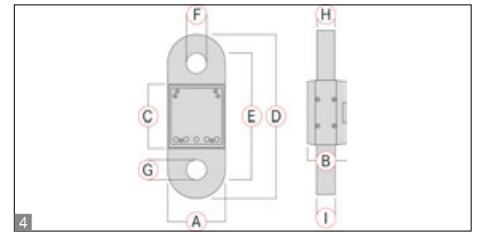
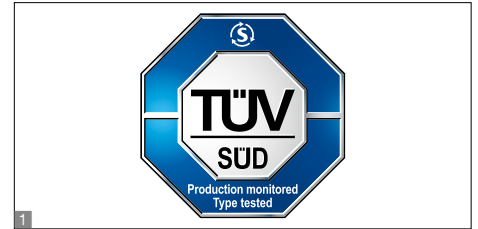

Compact crane scale with integrated display can also be used for tensile force measurement

Features

- **1** With the TÜV certification mark, the scale meets the requirements of the standard EN 13155 (Non-fixed load lifting attachments/ Breakage resistance) and EN 61010-1 (Electrical safety)
- With its high-quality finish, low weight and compact dimensions, this crane scale (tensile force gauge) is an essential device for industrial use, on building sites, in freight centres, ports etc.
- Because of its compact design it is also ideally suited for installation in systems where space is limited, etc.
- Ideally suited for determining weight quickly while loading and unloading
- Peak load display (peak hold)
- Hold function: For easy reading of the weighing result, the display can be “frozen” in different ways. Either automatically when the weighing value remains unchanged or manually by pressing the Hold key
- Tare: Resets the display to “0” when there is a load on the scale. Now removed or added loads are directly displayed

Technical data

- Large backlit LCD display, digit height 23 mm
- Material and design of housing/load support, models with [Max] ≤ 3 t: aluminium/stainless steel bearing [Max] > 3 t: steel/steel
- Internal rechargeable battery pack, operating time up to 30 h without backlight, charging time approx. 12 h
- Optional battery operation, 3×1.5 V AA not included in scope of delivery, operating time up to 40 h
- Precision: 0,2 % of [Max]
- Measuring frequency 60 Hz
- Further weighing units: kg, lb, N
- Permissible ambient temperature 5 °C/35 °C

Accessories

- **2** High-strength shackle, hot-dipped galvanised cast steel bracket, bow shaped. Scope of delivery: 2 shackles with lacquered screw bolts, suitable for models with [Max] ≤ 5 t: KERN YSC-01, € 100,- [Max] > 5 t: KERN YSC-02, € 210,-
- **3** Hook with safety catch, cast steel, galvanised and lacquered, non-revolving. Scope of delivery: 2 shackles, 1 lacquered screw bolt, 1 hook, suitable for models with [Max] ≤ 1 t: KERN YHA-01, € 170,- [Max] = 3 t: KERN YHA-02, € 190,- [Max] = 5 t: KERN YHA-03, € 230,- [Max] > 5 t: KERN YHA-04, € 410,-

15

STANDARD OPTION

Model	Weighing capacity [Max] kg	Readability [d] g	Net weight approx. kg	4 Dimensions					Price excl. of VAT ex works €	Option	
				A	B	C	D	F		DAKKS KERN	€
				mm	mm	mm	mm	mm			
HFA 600K-1	600	200	1,8	90	55	100	255	27	560,-	963-130H	200,-
HFA 1T-4	1000	500	1,8	90	55	100	255	27	580,-	963-130H	200,-
HFA 3T-3	3000	1000	2,0	90	61	100	255	27	630,-	963-132H	500,-
HFA 5T-3	5000	2000	4,0	90	61	100	255	30	690,-	963-132H	500,-
HFA 10T-3	10000	5000	6	90	71	100	275	40	1090,-	963-133H	700,-

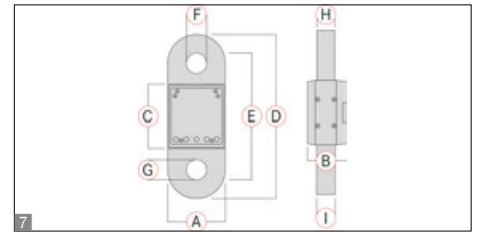
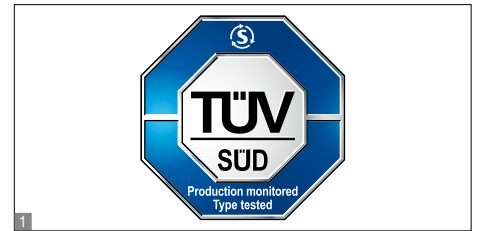

Compact crane scale for use in harsh environmental conditions or where space is limited, with convenient hand-held terminal

Features

- **1** With the TÜV certification mark, the scale meets the requirements of the standard EN 13155 (Non-fixed load lifting attachments/ Breakage resistance) and EN 61010-1 (Electrical safety)
- With its high-quality finish, low weight and compact dimensions, this crane scale (tensile force gauge) is an essential device for industrial use, on building sites, in freight centres, ports etc.
- Because of its compact design it is also ideally suited for installation in systems where space is limited, etc.
- Peak load display (peak hold)
- Hold function: When the weighing value remains unchanged the weight indicated on the display is automatically “frozen” until the Hold key is pressed
- Tare: Resets the display to “0” when there is a load on the scale. Now removed or added loads are directly displayed

- **2** Display device with integrated radio module, which the user can carry around with him, thanks to the convenient hand strap **3**, standard. In this way the weighing data can always be read off the display device by the user, even when the user is a long way from the load receptor (force gauge) or under poor lighting conditions. Range up to 20 m, LCD display, digit height 23 mm, rechargeable battery pack internal, standard. Operating time up to 30 h without backlight, charging time approx. 12 h. Can be reordered, KERN HFC-A01, **€ 60,-**
- Dimensions of display device W×D×H 85×64×256 mm
- Net weight 0,5 kg

Technical data

- Large backlit LCD display, digit height 23 mm
- Material and design of housing/load support, models with [Max] ≤ 3 t: aluminium/stainless steel bearing [Max] > 3 t: steel/steel

- Optional battery operation, 3×1.5 V AA not included in scope of delivery, operating time up to 40 h
- Precision: 0,2 % of [Max]
- Measuring frequency 10 Hz
- Further weighing units: kg, lb, N
- Permissible ambient temperature 5 °C/35 °C

Accessories

- **4** Internal rechargeable battery pack for load support, operating time up to 30 h, without backlight, charging time approx. 12 h
- **5** High-strength shackle, hot-dipped galvanised cast steel bracket, bow shaped. Scope of delivery: 2 shackles with lacquered screw bolts, suitable for models with [Max] ≤ 5t: KERN YSC-01, **€ 100,-** [Max] > 5t: KERN YSC-02, **€ 210,-**
- **6** Hook with safety catch, cast steel, galvanised and lacquered, non-revolving. Scope of delivery: 2 shackles, 1 lacquered screw bolt, 1 hook, suitable for models with [Max] ≤ 1t: KERN YHA-01, **€ 170,-** [Max] = 3t: KERN YHA-02, **€ 190,-** [Max] = 5t: KERN YHA-03, **€ 230,-** [Max] > 5t: KERN YHA-04, **€ 410,-**

STANDARD

CAL EXT UNIT BATT ACCU MULTI DMS 1 DAY

load receptors only

OPTION

ACCU DAKKS +3 DAYS

Model	Weighing capacity [Max] kg	Readability [d] g	Net weight approx. kg	7 Dimensions					Price excl. of VAT ex works €	Option	
				A mm	B mm	C mm	D mm	F mm		DAkKS Calibr. Certificate	
										DAkKS KERN	€
KERN HFC 600K-1	600	200	1,8	90	55	100	255	27	890,-	963-130H	200,-
KERN HFC 1T-4	1000	500	1,8	90	55	100	255	27	890,-	963-130H	200,-
KERN HFC 3T-3	3000	1000	2,2	90	61	100	255	27	950,-	963-132H	500,-
KERN HFC 5T-3	5000	2000	4,0	90	61	100	255	30	1020,-	963-132H	500,-
KERN HFC 10T-3	10000	5000	6	90	71	100	275	40	1410,-	963-133H	700,-

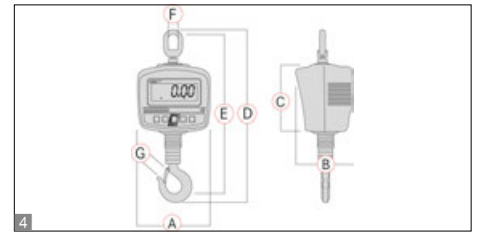
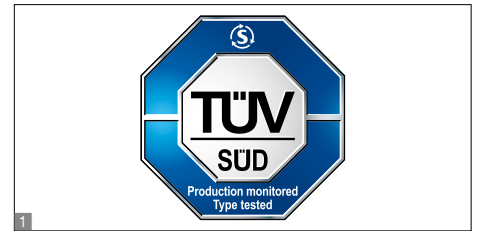

The professional alternative up to 600 kg with rear-facing second display

Features

- **1** With the TÜV certification mark, the scale meets the requirements of the standard EN 13155 (Non-fixed load lifting attachments/ Breakage resistance) and EN 61010-1 (Electrical safety)
- **2** Second display on the rear of the balance
- High mobility: thanks to rechargeable battery operation, compact, lightweight construction, it is suitable for the use in several locations (production, warehouse, dispatch department etc.)
- Hold function: When the weighing value remains unchanged the weight indicated on the display is automatically "frozen" until the Hold key is pressed
- Tare: Resets the display to "0" when there is a load on the scale. Now removed or added loads are directly displayed
- Hook with safety catch, revolving
- Shackle and safety catch made of nickel-plated steel
- **3** Radio remote control standard. Range up to 20 m. All functions can be selected (excl. ON/OFF). W×D×H 48×10×95 mm. Batteries included, 2×1.5 V AAA

Technical data

- Superior display size: digit height 25 mm, bright backlight for easy reading of weighing results, even in poor lighting conditions
- Internal rechargeable battery pack, operating time up to 30 h without backlight, charging time approx. 14 h
- Precision: 0,2% of [Max]
- Permissible ambient temperature 0 °C/40 °C

STANDARD

CAL EXT UNIT ACCU MULTI DMS 1 DAY

OPTION

DAkkS +3 DAYS

Model	Weighing capacity [Max] kg	Readability [d] g	Net weight approx. kg	4 Dimensions							Price excl. of VAT ex works €	Option	
				A mm	B mm	C mm	D mm	E mm	F mm	G mm		DAkkS KERN	Calibr. Certificate €
KERN HFB 150K50	150	50	2,2	163	126	158,5	415	385	26	25	345,-	963-129H	110,-
KERN HFB 300K 100	300	100	2,2	163	126	158,5	415	385	26	25	375,-	963-129H	110,-
KERN HFB 600K200	600	200	2,4	163	126	158,5	415	385	26	25	375,-	963-130H	200,-

15

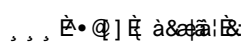



KERN HFD-M

Robust, high-resolution crane scale up to 12 t, now also with EC type approval [M] or protection type IP67



High mobility thanks to rechargeable battery operation, compact, lightweight construction, it is suitable for the use in several locations (production, warehouse, dispatch department etc.)



Solid shackles, non-revolving



Radio remote control standard. Range up to 20 m. All functions can be selected. W×D×H 65×24×100 mm. Batteries included, 1× 12 V 23A

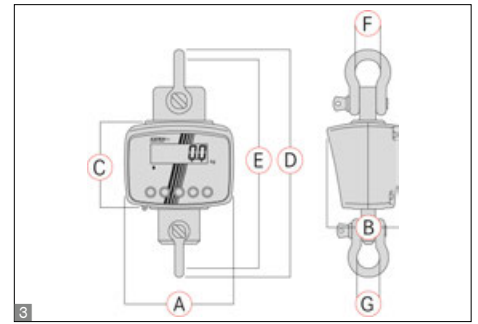
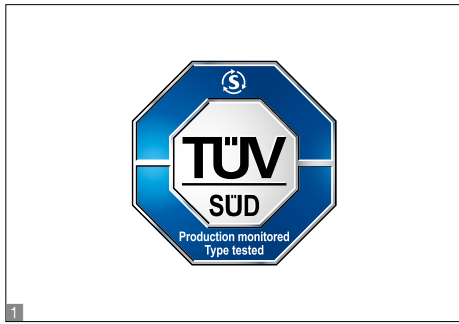

Features

- The models with M add-on have EC type approval and because of this they are ideal for use in verified applications such as, for example, calculation of a total price, based on weight
- The models with IP add-on have special spray and dust protection to IP67 and because of this they are ideal for use in harsh environments
- With the TÜV certification mark, the scales meet the requirements of the standard EN 13155 (Non-fixed load lifting attachments/ Breakage resistance) and EN 61010-1 (Electrical safety)
- Because of its stable construction and robust design, it is ideal for continuous use in industrial environment
- High mobility: thanks to rechargeable battery operation, compact, lightweight construction, it is suitable for the use in several locations (production, warehouse, dispatch department etc.)
- Hold function: When the weighing value remains unchanged the weight indicated on the display is automatically “frozen” until the Hold key is pressed
- Tare: Resets the display to “0” when there is a load on the scale. Now removed or added loads are directly displayed

Technical data

- Superior display size: digit height 30 mm, bright backlight for easy reading of weighing results, even in poor lighting conditions
- Internal rechargeable battery pack, as standard, operating time up to 70 h without back light, charging time approx. 12 h. Battery pack accessible from the outside, which means it is easy to replace
- Precision: 0,2 % of [Max]
- Permissible ambient temperature -10 °C/40 °C

Accessories

- Internal rechargeable battery pack for load support, operating time up to 70 h without backlight, charging time approx. 12 h, KERN HFD-A04, **€ 110,-**
- Charging station for external battery charging, scope of delivery: charging station, exchangeable battery, mains adapter, KERN HFD-A07, **€ 110,-**
- Hook with safety catch, cast steel, galvanised and lacquered, non-revolving, suitable for models HFD 600, HFD 1T: KERN HFD-A01, **€ 45,-**
HFD 3T: KERN HFD-A02, **€ 60,-**
HFD 6T, HFD 10T: KERN HFD-A03, **€ 100,-**
- Bluetooth data interface for wireless data transfer to PC or tablets, must be ordered at purchase, KERN HFD-A06, **€ 210,-**

STANDARD OPTION FACTORY

CAL EXT
 IP 67
 ACCU
 MULTI
 DMS
 1 DAY
 DAkkS +3 DAYS
 BT 4.0
 M +3 DAYS HFD-M

Model	Weighing capacity [Max] kg	Readability [d] g	Net weight approx. kg	3 Dimensions							Price excl. of VAT ex works €	Option			
				A	B	C	D	E	F = G	Verification KERN		€	DAkkS Calibr. Certificate KERN	€	
Triple range balance switches automatically to the next largest weighing capacity [Max] and readability [d]															
HFD 600K-1	150 300 600	50 100 200	9	194	129	145	421	383	50,8	370,-	-	-	963-130H	200,-	
HFD 1T-4	300 600 1500	100 200 500	9	194	129	145	421	383	50,8	380,-	-	-	963-130H	200,-	
HFD 3T-3	600 1500 3000	200 500 1000	10	194	129	145	421	383	50,8	590,-	-	-	963-132H	500,-	
HFD 6T-3	1500 3000 6000	500 1000 2000	15	194	129	145	477	426	68,3	640,-	-	-	963-132H	500,-	
HFD 10T-3	3000 6000 12000	1000 2000 5000	20	194	129	145	573	510	82,5	760,-	-	-	963-133H	700,-	
Protection against dust and water splashes IP67															
HFD 600K-1IP	150 300 600	50 100 200	9	194	129	145	421	383	50,8	570,-	-	-	963-130H	200,-	
HFD 1T-4IP	300 600 1500	100 200 500	9	194	129	145	421	383	50,8	580,-	-	-	963-130H	200,-	
HFD 3T-3IP	600 1500 3000	200 500 1000	10	194	129	145	421	383	50,8	790,-	-	-	963-132H	500,-	
HFD 6T-3IP	1500 3000 6000	500 1000 2000	15	194	129	145	477	426	68,3	840,-	-	-	963-132H	500,-	
HFD 10T-3IP	3000 6000 12000	1000 2000 5000	20	194	129	145	573	510	82,5	960,-	-	-	963-133H	700,-	
Note: For applications that require verification, please order verification at the same time, initial verification at a later date is not possible. Verification at the factory, we need to know the full address of the location of use.															
HFD 600K-1M	600	200	9	194	129	145	421	383	50,8	480,-	965-130H	132,-	963-130H	200,-	
HFD 1T-4M	1500	500	9	194	129	145	421	383	50,8	480,-	965-130H	132,-	963-130H	200,-	
HFD 3T-3M	3000	1000	10	194	129	145	421	383	50,8	640,-	965-132H	200,-	963-132H	500,-	
HFD 6T-3M	6000	2000	15	194	129	145	477	426	68,3	790,-	965-132H	200,-	963-132H	500,-	
HFD 10T-3M	12000	5000	20	194	129	145	573	510	82,5	900,-	965-133H	300,-	963-133H	700,-	

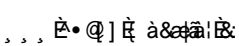

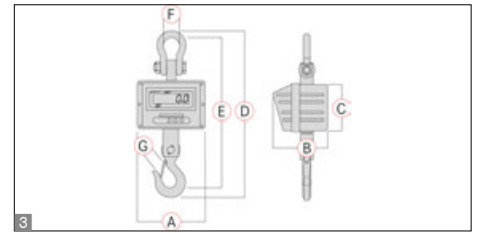

Robust industrial crane scale with bright LED display for optimum reading in unfavourable ambient conditions

Features

- **1** With the TÜV certification mark, the scales meet the requirements of the standard EN 13155 (Non-fixed load lifting attachments/ Breakage resistance) and EN 61010-1 (Electrical safety)
- Professional device for robust applications in production, quality control, logistics etc. Because of its stable construction and robust design, it is ideal for continuous use in industrial environment
- High mobility: thanks to rechargeable battery operation, compact, lightweight construction, it is suitable for the use in several locations (production, warehouse, dispatch department etc.)

- Adaptation to unstable environmental conditions by changing the readability
- Hold function: When the weighing value remains unchanged the weight indicated on the display is automatically "frozen" until the Hold key is pressed
- Tare: Resets the display to "0" when there is a load on the scale. Now removed or added loads are directly displayed
- Hook with safety catch, revolving
- **2** Radio remote control standard. Range up to 20 m. All functions can be selected (excl. ON/OFF). WxDxH 48x10x95 mm. Batteries included, 2x1.5 V AAA

Technical data

- Superior display size: digit height 30 mm, bright with high contrast for easy reading of weighing results, even in poor lighting conditions
- Internal rechargeable battery pack, operating time up to 50 h without backlight, charging time approx. 14 h
- Precision: 0,2 % of [Max]
- Permissible ambient temperature 0 °C/40 °C

STANDARD

CAL EXT ACCU MULTI DMS 1 DAY 2 DAYS

OPTION

DAKKS +3 DAYS

Model	Weighing capacity [Max] kg	Readability [d] g	Net weight approx. kg	3 Dimensions							Price excl. of VAT ex works €	DAKKS Calibr. Certificate	
				A mm	B mm	C mm	D mm	E mm	F mm	G mm		DAKKS KERN	€
HFM 1T0.1	1000	100	14	270	200	175	610	540	68	40	690,-	963-130H	200,-
HFM 3T0.5	3000	500	16	270	200	175	610	540	74	40	710,-	963-132H	500,-
HFM 5T0.5	5000	500	24	300	230	190	730	650	74	55	930,-	963-132H	500,-
HFM 10T1	10000	1000	34	300	230	190	840	750	92	60	1260,-	963-133H	700,-

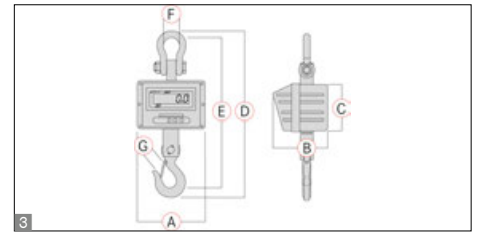

Robust industrial crane scale with EC type approval [M] – perfect for high-capacity applications which require verification

Features

- **1** With the TÜV certification mark, the scales meet the requirements of the standard EN 13155 (Non-fixed load lifting attachments/ Breakage resistance) and EN 61010-1 (Electrical safety)
- Professional device for robust applications in production, quality control, logistics etc. Because of its stable construction and robust design, it is ideal for continuous use in industrial environment
- High mobility: thanks to rechargeable battery operation, compact, lightweight construction, it is suitable for the use in several locations (production, warehouse, dispatch department etc.)
- Adaptation to unstable environmental conditions by changing the readability

- High resolution readability: Readability [d] for 5 sec increased by one decimal place at the touch of a key, only for models with EC type approval
- Hold function: When the weighing value remains unchanged the weight indicated on the display is automatically “frozen” until the Hold key is pressed
- Tare: Resets the display to “0” when there is a load on the scale. Now removed or added loads are directly displayed
- Hook with safety catch, revolving
- **2** Radio remote control standard. Range up to 20 m. All functions can be selected (excl. ON/OFF). W×D×H 48×10×95 mm. Batteries included, 2×1.5 V AAA

Technical data

- Superior display size: digit height 30 mm, bright with high contrast for easy reading of weighing results, even in poor lighting conditions
- Internal rechargeable battery pack, as standard, operating time up to 50 h without back light, charging time approx. 14 h
- Precision: 0, 2 % of [Max]
- Permissible ambient temperature 0 °C/40 °C

STANDARD					OPTION	FACTORY

Model	Weighing capacity [Max] kg	Readability [d] g	Net weight approx. kg	3 Dimensions							Price excl. of VAT ex works €	Option			
				Verification		DAkkS Calibr. Certificate									
					€	DAkkS	€								
KERN HFO 1.5T0.5M	1500	500	16	270	200	175	610	540	60	35	1030,-	965-130H	132,-	963-130H	200,-
KERN HFO 3T1M	3000	1000	17	270	200	175	610	540	80	47	1130,-	965-132H	200,-	963-132H	500,-
KERN HFO 6T2M	6000	2000	30	300	230	190	730	650	80	54,4	1400,-	965-132H	200,-	963-132H	500,-

Note: For applications that require verification, please order verification at the same time, initial verification at a later date is not possible. Verification at the factory, we need to know the full address of the location of use.

1 ONLY WHILE STOCKS LAST!

Printers



Second display



Weighing table



Ioniser



Stands



Interface adapter



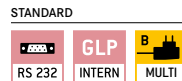
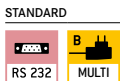
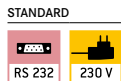

Important note for printer orders:

Please state your balance model when ordering, so that the printer can be preconfigured in the factory to suit your balance.

**Matrix needle printer
KERN 911-013**

For printing weighing results on normal paper, which is ideal for long-term archiving.

**Matrix needle printer
KERN YKN-01**

For printing weighing results on normal paper, which is ideal for long-term archiving.

**Thermal printer
KERN YKB-01N**

For printing weighing results, recipes, quantities etc. or for GLP record keeping of balance adjustment with date and time print. FLP/GMP compliant print form available as standard. Language versions: DE, EN, FR.

Technical data

- Needle print
- Speed: 1,8 line/s
- Max. 40 characters per line
- Width of the paper strip: 57 mm wide
- Operation via mains adapter 230 V/50 Hz (standard EU), as standard
- Dimensions housing: W×D×H 100×180×106 mm
- Not suitable for KERN PNS/PNJ, PES/PEJ ranges
- Interface cable not included with delivery

Price printer without interface cable, KERN 911-013, **€ 390,-**

Technical data

- Needle print
- Speed: 1 line/s
- Max. 16 characters per line
- Width of the paper strip: 44 mm wide
- Operation via mains adapter 230 V/50 Hz (standard EU/GB/USA), as standard
- Dimensions housing: W×D×H 158×106×40 mm
- Interface cable not included with delivery

Price printer without interface cable, KERN YKN-01, **€ 230,-**

Technical data

- Thermal print
- Speed: 0,75 lines/s
- Max. 40 characters per line
- Width of the paper strip: 112 mm wide
- Operation via mains adapter 230 V/50 Hz (standard EU/GB/USA), as standard
- Dimensions housing: W×D×H 165×140×50 mm
- Interface cable not included with delivery

Price printer without interface cable, KERN YKB-01N, **€ 310,-**

Accessories

- Paper rolls (10 pcs.), KERN 911-013-010, **€ 35,-**
- Universal mains adapter, standard EU/GB/US, KERN ABS-A01, **€ 80,-**

Accessories

- Paper rolls (5 pcs.), KERN YKN-A01, **€ 35,-**

Accessories

- Paper rolls (10 pcs.), KERN YKB-A10, **€ 55,-**

Individual header data:

For printers **KERN 911-013, YKN-01, YKB-01N and YKE-01 (in combination with YKI-02)** the free software **KERN SHM-01** (see www.kern-sohn.com) can be used to print 4 header lines on the printout (see marking on balance). Compatible models: KERN 440, DE, FCB, FKB-A, PCB, PCD.

Printers



STANDARD



STANDARD



Important note for printer orders:

Please state your balance model when ordering, so that the printer can be preconfigured in the factory to suit your balance.

Thermal statistics printer KERN YKS-01

For printing weighing results, recipes etc. or for GLP record keeping of weighing data with date and time print. Numerator; with statistical functions such as count and total of all measurements, minimum and maximum values of the main unit, range, average value, standard deviation, available units: mg, g, kg, pcs. Language versions: DE, EN, FR.

Technical data

- Thermal print
- Speed: 0,75 lines/s
- Max. 40 characters per line
- Width of the paper strip: 112 mm wide
- Operation via mains adapter 230 V/50 Hz (standard EU/GB/USA), as standard
- Dimensions housing: W×D×H 165×140×50 mm
- Interface cable not included with delivery
- Note: Please order the matching paper roll with it, see accessories
- Not suitable for KERN EWJ, PFB-M range as well as KERN moisture analysers and counting scales

Price printer without interface cable,
KERN YKS-01, **€ 390,-**

Accessories

- Paper rolls (10 pcs.), KERN YKB-A10, **€ 55,-**

Thermal label printer KERN YKE-01

Affordable universal label printer to print out weighing results on thermal labels. ASCII-capable. Comfortable Auto-Forward function for automatic jump from label to label (only with KERN standard labels)

Technical data

- Thermal print
- Speed: 22 mm/s
- Max. 82 characters per line
- Width of the paper strip:
YKE-A02: 78 mm
YKE-A03: 112 mm
- Operation via mains adapter 230 V/50 Hz (standard EU/GB/USA), as standard
- Dimensions housing: W×D×H 150×155×65 mm
- Interface cable not included with delivery
- Note: Please order the matching label roll with it, see accessories
- Not suitable for KERN BFS, CCS, CFS, CPB, DAB, DBS, DLB, IFS, KFS-TM, RPB ranges, counting scales

Price printer without interface cable,
KERN YKE-01, **€ 590,-**

Accessories

- Paper roll (1 pc.), Dimensions labels:
W×D 73×61 mm, 100 labels,
KERN YKE-A02, **€ 30,-**
W×D 105×48 mm, 45 labels,
KERN YKE-A03, **€ 30,-**

Individual header data:

For printers **KERN 911-013, YKN-01, YKB-01N and YKE-01 (in combination with YKI-02)** the free software **KERN SHM-01** (see www.kern-sohn.com) can be used to print 4 header lines on the printout (see marking on balance). Compatible models: KERN 440, DE, FCB, FKB-A, PCB, PCD.

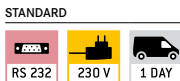
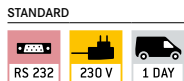

Important note for printer orders:

Please state your balance model when ordering, so that the printer can be preconfigured in the factory to suit your balance.

**Dot matrix printer
KERN YKG-01**

High-quality dot matrix printer

Flexible and rapid dot matrix printer for retail, the catering trade and for restaurant kitchens. To print the weights on normal paper, which is ideal for long-term archiving. This model has an interchangeable interface and you will be impressed by how easy it is to replace the paper and ribbon

Technical data

- Needle print
- Speed: 4,7 line/s
- Max. 42 characters per line
- Supported paper widths: 58 mm, 70 mm, 76 mm (roll)
- Operation via mains adapter 230 V/50 Hz standard EU, as standard
- Interfaces: RS-232, cash drawer connection, bidirectional parallel
- Interface cable not included with delivery
- Dimensions housing B×T×H 160×248×139 mm
- Not suitable for KERN DAB, DBS, DLB, FKT, RFE ranges

Price printer without interface cable, KERN YKG-01, **€ 550,-**

Accessories

- Paper rolls (5 pcs.), KERN YKG-A01, **€ 30,-**

**Thermal label printer
KERN YKH-01**

High-quality thermal printer – fast, robust, user-friendly

Robust, low-maintenance dot matrix printer for retail, the catering trade and for restaurant kitchens. Extremely compact and long-lasting. Thanks to the waterproof switch cover it is particularly suitable for use under tough, loud environmental conditions

Technical data

- Thermal print
- Speed: 2 line/s
- Max 64 characters per line
- Supported paper widths: 58 mm, 80 mm (roll)
- Operation via mains adapter 230 V/50 Hz standard EU, as standard
- Interfaces: RS-232
- Interface cable not included with delivery
- Dimensions housing B×T×H 140×199×146 mm
- Not suitable for KERN DAB, DBS, DLB, FKT, RFE ranges

Price printer without interface cable, KERN YKH-01, **€ 370,-**

Accessories

- Paper rolls (5 pcs.), KERN YKH-A01, **€ 30,-**

Individual header data:

For printers **KERN 911-013, YKN-01, YKB-01N and YKE-01 (in combination with YKI-02)** the free software **KERN SHM-01** (see www.kern-sohn.com) can be used to print 4 header lines on the printout (see marking on balance). Compatible models: KERN 440, DE, FCB, FKB-A, PCB, PCD.

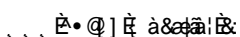

Interface cable for RS-232

For direct connection to a printer or PC, cable length approx. 1.5 m.
The interface parameters can be set using the balance keypad.



The interface cable is **free of charge** if you purchase balance, printer or Ethernet-/WiFi-/Bluetooth adapter together.

Printer, ...	PC, YKI-01/-02/-03 KERN	911-013, YKB-01N, YKN-01 KERN	YKE-01 KERN	YKG-01, YKH-01 KERN	YKS-01 KERN	Price cable excl. of VAT ex works €
Balance						
440, 572, 573, ALJ-AM, ALS-A, ALT-B, CDS, CKE, DE-D, DS, EMB-V, FCB, FKA, FKB, FK, FKB-A, IKT, KB, PCB, PCD, PLJ-A, PLJ-F, PLS-A, PLS-F, PLE, PLT, KDP				572-926		46,-
FKT				572-926		46,-
BAN, BKN, BXS, IXS, KXS-TM, SXS				KXS-A04 (Factory Option)		100,-
EOC, IOC, BID, KIB-T, KIB-TM				EOC-A12		46,-
YKV-01, KGP	572-926			-		
ABJ-NM, ABS-N				ACS-A01		90,-
BFA, BFB, BFN (until year of construction 2019), GAB-N, GAB-P, GAT, IFB, KFB-TM, KFN-TM, NFB, NFN (until year of construction 2019) PFB, SFB, UFA, UFB, UFC, UFN				CFS-A01		46,-
BFS, CPB, EWJ, KFS-TM, IFT, PFB, PFB-M, RPB				CFS-A01		
CFS, CCS, KFS-TM, IFS (from year of production 2015)	-	CFS-A01	-	-	-	
ABT-NM, PBj, PBS				770-926		
DAB, DBS, DLB	572-926			-	-	
ABP, KFS-T				MLB-A05		
ADB, ADJ, ACS, ACJ, PNS/PNJ				MLB-A05		
HFT				KFF-A01		
EG-N, EW-N, PES/PEJ (not compatible with YKB-01N, YKN-01)				474-926		
CCA				CCA-A01		
RFE (not compatible with YKN-01)	-	CFS-A01	-	CFS-A01	-	

With products from KERN you are ready to face the challenges of Industry 4.0

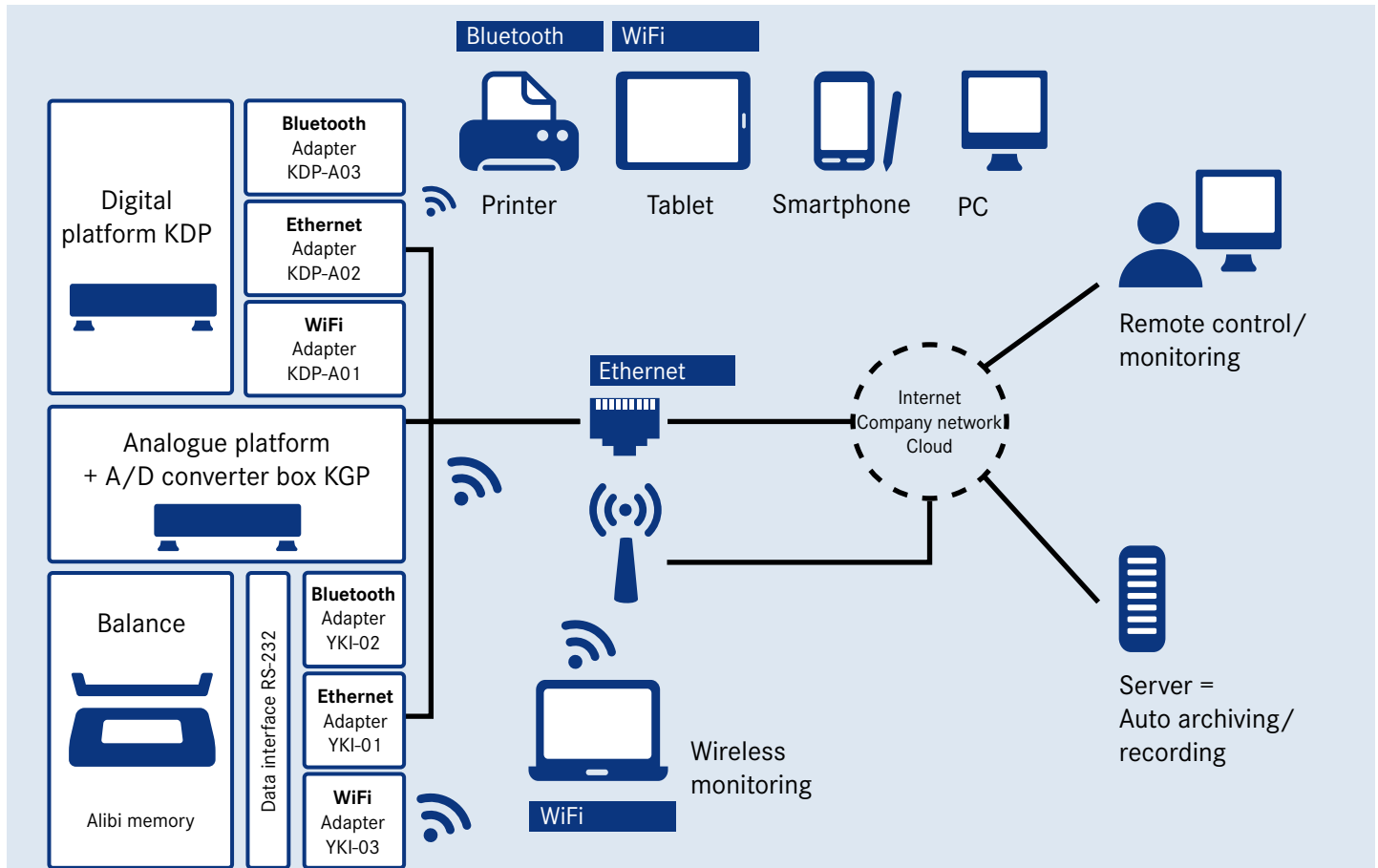

We will help to combine industrial production with the latest information and communication technology, with the aim of improving quality, reducing costs and using time and resources more efficiently so that you are able to react to future requirements in a more flexible manner. You will benefit from our uniform data protocol combined with our BalanceConnection 4.0 data software, for details please see page 174/175.

KERN Software BalanceConnection SCD-4.0

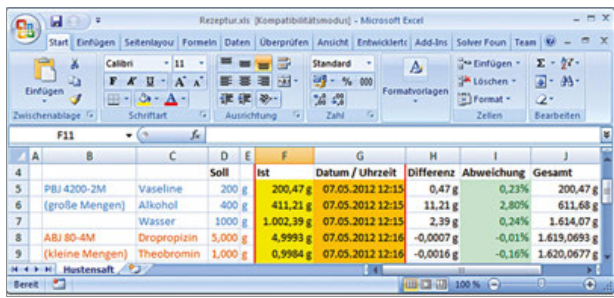

Easy transfer and editing of measuring results e.g. in Microsoft® Excel

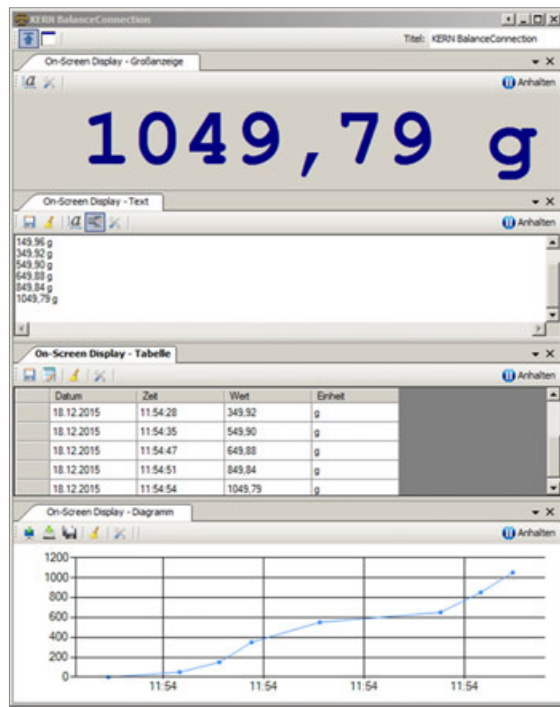

Different on-screen displays with export function

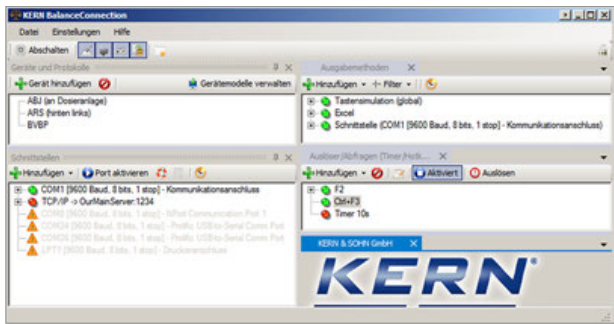

Full overview of devices, outputs, queries, interfaces, etc. shown on the output window immediately.

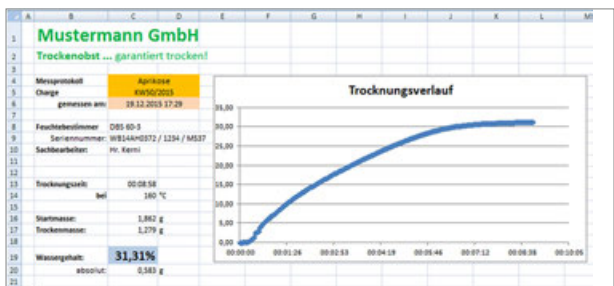

Measurement report with line chart showing a moisture analysis

! Tip

Do you have any questions? The team from our Industry 4.0 centre of expertise will be happy to help: e-mail: ITsupport@kern-sohn.com Or download a free demo version of the BalanceConnection software: <http://balanceconnection.kern-sohn.com/demo>

Flexible recording or transfer of measurements, particularly to Microsoft® Excel or Access

Features

- For operating systems Windows XP, Vista, 7, 8, 8.1, 10
- Supports balances measuring devices with RS 232, RS 485, Bluetooth, LAN or WiFi network (TCP/UDP/IP)
- Highly flexible formatting of the output (any order, formatting and rounding), particularly recording of date and time for every value transferred, if required
- Any number of devices/interfaces can be connected, as well as simultaneous and synchronised recording of several balances
- Key-activated or time-controlled interrogation of measurements or trigger of device functions, also for continuous recording
- The interface protocols for KERN balances are already predefined (standard configuration)

- Compatible interface cable included when you order a KERN balance at the same time
- Many different transfer and recording options:
 - Microsoft® Excel/Access/Word in the foreground or background
 - Other Windows applications (through key simulation), e.g. shipping software or ERP system (SAP, Sage, etc.)
 - File recording (e.g. as text or CSV file)
 - Print out on text or label printer
 - Screen output such as large display, line chart (drying curve for moisture analyzer), histogram, etc.

Benefits

- Typing errors during e.g. manual transfer are avoided
- Automatic recording, e.g. for long-term tests
- GLP-compliant lab software
- Can be used across different branches and applications
- Also available as a cost-optimised package with 5 licenses, **you save more than 30 %!**
- Also available immediately as a download license
- Scope of supplies: 1 CD, 1 license, KERN SCD-4.0, **€ 150,-**
- Scope of supplies: 1 CD, 5 licenses, KERN SCD-4.0-S05, **€ 500,-**
- Scope of supplies: Download link for 1 license, KERN SCD-4.0-DL, **€ 150,-**

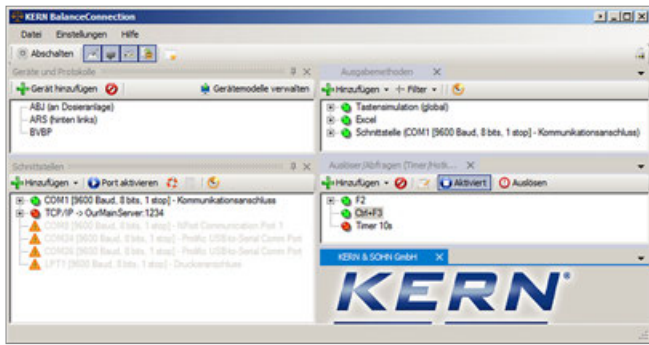
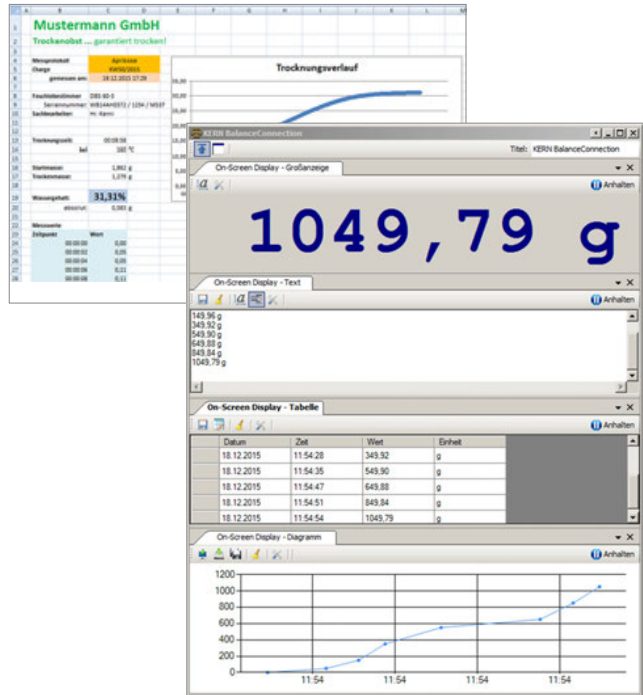
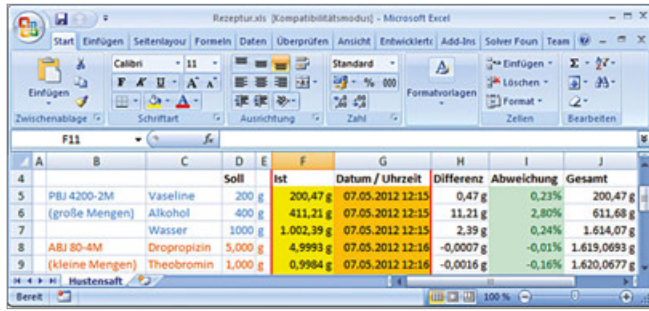

Professional and highly flexible recording or transmission of measured values, in particular also to Microsoft® Excel or Access

Features

- For operating systems Windows XP, Vista, 7, 8, 8.1, 10
- Supports balances measuring devices with RS 232, RS 485, Bluetooth, LAN or WiFi network (TCP/UDP/IP)
- Highly flexible formatting of the output (any order, formatting and rounding), particularly recording of date and time for every value transferred, if required
- Any number of devices/interfaces can be connected, as well as simultaneous and synchronised recording of several balances
- Key-activated or time-controlled interrogation of measurements or trigger of device functions, also for continuous recording
- The interface protocols for KERN balances are already predefined (standard configuration)
- Compatible interface cable included when you order a KERN balance at the same time
- Many different transfer and recording options:
 - Microsoft® Excel/Access/Word in the foreground or background
 - Other Windows applications (through key simulation), e.g. shipping software or ERP system (SAP, Sage, etc.)
 - File recording (e.g. as text or CSV file)
 - Print out on text or label printer
 - Screen output such as large display, line chart (drying curve for moisture analyzer), histogram, etc.

Additional features of the BalanceConnection PRO version:

- ODBC/SQL databases such as SQL Server or MySQL
- Transfer to HTTP Webservices/Web forms
- Histogram
- Enables the connection of medical balances to practice EDP systems using the device data transfer protocol (GDT) and also the HL7 protocol
- Implementation of programs/scripts using freely-definable command lines
- Command sequences
- Defining the conditions for specific events and the reaction to these events
- Filter for stability recognition (configurable value storage)
- Central configuration repository, e.g. on the network
- On-screen displays with configurable user interface for flexible balance operation

Benefits

- Ideal software where weighing data which has been collected needs to be transferred to a Windows PC
- Particularly suitable for professional integration of weighing systems into existing networks where there is a high demand for automated data transfer and further processing, for integration of databases
- Automatic recording, e.g. for long-term tests
- GLP-compliant lab software
- Can be used across different branches and applications
- Also available as a cost-optimised package with 5 licenses, **you save more than 30 %!**
- Also available immediately as a download license
- Scope of supplies: 1 CD, 1 License KERN SCD-4.0-PRO, **€ 290,-**
- Scope of supplies: 1 CD, 5 Licenses KERN SCD-4.0-PRO5, **€ 990,-**
- Scope of supplies: Download link for 1 License, KERN SCD-4.0-PRO-DL, **€ 290,-**

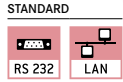

RS-232/Ethernet adapter KERN YKI-01

Adapter to connect balances, force measuring devices etc. with an RS-232 interface 2 to an IP-based Ethernet network 1. The adapter allows direct integration of measuring devices into most company networks, with automatic configuration using DHCP or statistical IP allocation. You can access the current measuring data at any time from within the whole network, without having to use additional cables. The adapter supports a wide range of configurational options using the enclosed administration software or by the web interface. The driver delivered with the goods allows you to access the measuring device with existing, non-network-compatible applications using a virtual COM port. Compatible with KERN BalanceConnection software. DIN track mount 3 or free-standing.

Scope of delivery: RS-232 Ethernet adapter with 1x Port RS-232 1, mains adapter 4, CD (driver, software, operating instructions), adhesive feet, (interface cable see page 174),

KERN YKI-01, € 290,-



RS-232/WiFi-Adapter KERN YKI-03

High-quality adapter for the wireless connection of balances, force measuring devices etc. with RS-232 interface to WiFi-enabled devices, such as tablets, laptops, Smartphones etc. In this way, where there is a physical separation or a large distance between the devices, the weighing data from one or several balances can be easily transferred without cable to a WiFi device or a network (relevant software on the WiFi device needed, not included in delivery). The adapter allows direct integration of measurement devices into most company networks, with automatic configuration using DHCP or statistical IP allocation. You can access the current measuring data at any time from within the whole network, without having to use additional cables. The adapter supports a wide range of configurational options using the enclosed administration software or by the web interface. The driver delivered with the goods allows you to access the measurement device with existing, non-network-compatible applications using a virtual COM port. Compatible with KERN Software BalanceConnection.

The adapter also has an Ethernet interface for a wired connection to an IP-based Ethernet network 1. Thanks to the screw terminals 2, the power connection can be implemented individually using individual wires or using the robust, screw-in power connector 3. Large input voltage range from 12 V-48 V. Suitable for wall mounting and DIN track mount 4 or free-standing.

Scope of delivery: RS-232/WiFi adapter, mains adapter, network cable (1 m), driver CD, (interface cable see page 174),

KERN YKI-03, € 690,-



Note: To connect to your network, you will need information from your network administrator. We recommend discussing connecting your device into your network with the administrator before you place your order.

Note: If you order a KERN balance at the same time, then the interface cable is **free of charge** (please specify balance model).

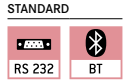

RS-232/Bluetooth-Adapter KERN YKI-02

Adapter for the wireless connection of balances, force measuring devices etc. with an RS-232 interface to Bluetooth devices, such as Bluetooth printers, tablets, laptops, Smartphones etc. In this way, where there is a physical separation or a large distance between the devices, the weighing data from one or several balances can be easily sent without cable and printed on a Bluetooth printer or transferred to a Bluetooth device (you would need the relevant software on the Bluetooth device, not included with the delivery). The compact adapter with its attractive design can usually be connected directly to the balance **1**, e.g. an additional interface cable would not be necessary. Bluetooth adapter will be powered by the balance (if compatible) or with the mains adapter which is supplied as standard **2**. Range up to 100 m outside, depending on obstacles, such as, walls, the sensitivity and type of antenna of the receiver. Intersections of sending and receiving lines using the DCE/DTE switch **3**. Compatible with KERN Software BalanceConnection.

Scope of delivery: RS-232/Bluetooth adapter, mains adapter (EU/UK/USA/AUS/CH) **2**, USB-A to Mini-USB-B cable **4**, gender changer **5**, driver CD, (interface cable see page 174),

KERN YKI-02, € 310,-



Note: To connect to your network, you will need information from your network administrator. We recommend discussing connecting your device into your network with the administrator before you place your order.

Note: If you order a KERN balance at the same time, then the interface cable is **free of charge** (please specify balance model).



**Large display
KERN YKD-A02**

with superior display size, digit height 3" (76 mm). Luminescent, red LED display for easy reading of weight, even from a distance or under poor lighting conditions. 6 segments, mains connection as standard (230 V, EU/GB), connection using RS-232 data interface, dimensions WxDxH 541x55x180 mm.

Suitable for series IFB, BFB, NFB, UFA, UFB,

KERN YKD-A02, € 220,-



**Signal lamp
KERN CFS-A03**

Signal lamp for visual support of weighing with tolerance range. Three-colour LED, red, green, yellow. Power supply via balance using RS-232. Total dimensions WxDxH 100x180x300 mm

Suitable for series BFB, BFN, BID, CKE, CPB-N, GAB-N, GAB-P, IFB, IFS, IOC, KFB-TM, KFN-TM, KIB-TM, NBB, NFB, NFN, SFB, UFA, UFB, UFC, UFN,

KERN CFS-A03, € 250,-



**Power supply adapter set
KERN YKA-02**

from standard EU to GB/US/AUS/CH etc. Four pieces. Ideal for devices with Class II protection (not earthed). Ideal for Euro moulded plug,

KERN YKA-02, € 35,-



**2nd RS-232 data interface
KERN CFS-A04**

separate Y cable, e.g. for simultaneous connection of a printer and a signal lamp.

Suitable for series BAN, BFB, CFS, CPB-N, GAB-N, GAB-P, IFB, KFB-TM, NFB, NFN, UFN, UFA, UFB, SFB,

KERN CFS-A04, € 35,-



**RS-232/USB adapter
KERN AFH 12**

to connect peripheral devices with USB connection, fits on all balances and measuring instruments with RS-232 port.

Please order the appropriate RS-232 interface cable for your balance at the same time, see table on page 173

Scope of delivery: Converter cable, CD with driver,

KERN AFH 12, € 85,-

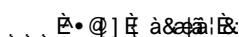



**Stand (tripodal)
KERN YKP-01**

stable and robust, to elevate display device, stainless steel, height-adjustable, large three-legged adjustable foot, height of stand approx. 750–1000 mm, Factory Option.

Suitable for series BFA, BBB, BFN, BBN, KEN-TM, NFN, SFB (from weighing plate size W×D 500×400 mm), UFN,

KERN YKP-01, € 370,-



**Stand (tripodal)
KERN YKP-02**

stable and robust, to elevate display device, stainless steel, height-adjustable, large three-legged adjustable foot, height of stand approx. 750–1000 mm, Factory Option.

Suitable for series BFB, BXS, BFS, BFA, BBB, BBN, BKN, IFS, IFB, KFE-TM, KXG-TM, KXS-TM, KEN-TM, NFB, NBB, SFE, UFA, UFB, UFC,

KERN YKP-02, € 190,-



**Protective dust cover
KERN ABS-A08**

For protection from dust and light.

Suitable for all KERN analytical balances and precision balances with glass draught shield,

KERN ABS-A08, € 30,-



**Tare pan
KERN RFS-A02**

Made of stainless steel, which makes cleaning easy and hygienic. Ideal for weighing loose screws, small parts, fruit, vegetables, cheese, etc.

- W×D×H 370×240×20 mm
- Net weight approx. 524 g

KERN RFS-A02, € 55,-



**Tare pan with pan beam
KERN CH-A01N**

Made of stainless steel. Ideal for weighing loose small parts, fruit, vegetables etc. Max. load 30 kg. Removable tare pan which makes cleaning easy and hygienic.

- Suitable for models KERN CH 15K20, HCB 20K10, HCN 20K50IP, HDB-N, HDB-XL
- Dimensions: tare pan, Ø/H 160×40 mm (dim. outside), 240×40 mm (dim. inside)
 - Pan beam: W×D×H 290×240×300 mm 290×240×340 mm (incl. tare pan)
 - Total net weight approx. 500 g

KERN CH-A01N, € 70,-



**Universal density set
KERN YDB-03**

Universal density set for precise and convenient density determination of liquids and solids $\leq/\geq 1$. Suitable for all current KERN analytical balances.

Scope of delivery: Beaker (Ø×H 84×113 mm), thermometer, sample holder, adapter, equalising weights, volume plummet (stainless steel, 20 g), universal submersible basket for solid bodies which float and sink. The wire of the submersible basket has a diameter of 0.5 mm and therefore complies with the requirements of DIN EN ISO 1183-1 (test methods for the determination of density of non-foamed plastics), KERN YDB-03, € 390,-

Optional:
Density determination of the volume plummet, DAkkS calibration certificate with all data relating to the density and volume, KERN 962-335V, € 143,-



STANDARD



Ioniser to neutralise electrostatic charge KERN YBI-01A

Goods to be weighed which are non-conductive, such as plastic, china, glass, etc often carry electrostatic charge. The electromagnetic field which then occurs between the goods to be weighed and the balance can cause the weighing result to be distorted by up to a gramme. Therefore, when weighing in milligrammes or even smaller increments, we recommend neutralising the electrostatic charge with the KERN AC-Korona discharge ioniser. With feet  supplied with the ioniser, it can be positioned conveniently next to the balance or you can manually direct it from all sides onto a particular item to be weighed.

- Discharge of ozone 0,05 ppm/h
- Total dimensions W×D×H
115×100×60 mm (Adjustable foot retracted),
115×110×80 mm (Adjustable foot folded out)
- Net weight approx. 0,31 kg
- Mains connection 100–240 V, 50/60 Hz, AC power supply, DC 12 V, 500 mA, output,

KERN YBI-01A, € 890,-

Weighing table KERN YPS-03

The KERN YPS-03 weighing table has been constructed to absorb vibrations and oscillations, which would otherwise distort the weighing result.

The YPS-03 weighing table consists of:

- a heavy, polished granite slab (24 kg) and is positioned on absorbing rubber components and is used as a surface on which to stand the analytical balance
- a work table, the work surface of which surrounds the slab and offers many storage options. The sturdy powder-coated steel frame has four height-adjustable feet, which can be used to accurately level the weighing table if the floor is at all uneven
- You can work in an ergonomic way at the weighing table whether you are in a standing or seated position. The inlet on the front of the table offers enough space for you to sit down and operate the scale without touching the weighing table.
- All surfaces are easy and hygienic to clean

- Suitable for all KERN analytical balances with total dimensions $\leq W \times D$ 300×400 mm
- Total dimensions W×D×H
785×600×800 mm (Height adjustable)
- Dimensions granite slab, W×D×H
300×400×80 mm
- Net weight approx. 46 kg

Ready for shipping in 2 working days. Dispatch complete on pallet, simple self-assembly. Please ask for dimensions, gross weight, shipping costs,

KERN YPS-03, € 850,-

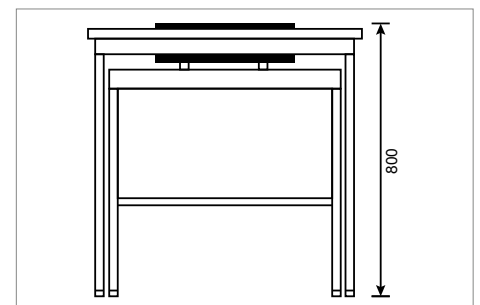
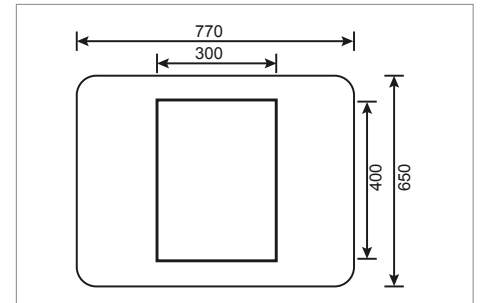



STANDARD



Roller conveyor KERN YRO-01/ YRO-02/ YRO-03

Through the smooth-running KERN roller conveyor attachments, KERN YRO, you can convert your platform scale into a robust measuring system for rapid and flexible weight determination in conveyor applications

Especially suitable for use in production and dispatch lines, where time means money. The goods or packages can either be weighed as they pass over the balance or, at fixed stations, heavy goods can easily be pushed onto the scale thanks to the roller conveyor and moved onto the connected roller conveyor

- Simply connect the roller conveyor attachment to a platform (e.g. KERN IFB, IFS, IXS, KFP, KXP, SXS) – done!
- Robust aluminium profile frame. The modular design means that you can easily disassemble it for cleaning or to replace individual components
- Smooth-running, hot-dip galvanised steel rollers with ball bearings
- Conductive rollers
- Suitable for use in dry environments
- Roller distance approx. 30 mm
- Direction of movement is lengthways

- Scope of delivery: 1 roller conveyor attachment (without scale)
- We are happy to adapt the roller conveyor to your scale, adjust the preload or switch-on tolerance, etc. Please ask for your individual offer, your personal KERN contact person will be happy to help you

Model	Total dimensions W×D×H	Suitable for platforms with weighing plate sizes W×D	Total net weight approx.	Price excl. of VAT ex works €
KERN	mm	mm	kg	
YRO-01	405×305×130	400×300	6	660,-
YRO-02	505×405×130	500×400	9	680,-
YRO-03	655×505×130	650×500	12	910,-



TIPS FROM THE EXPERTS

As well as our balances and test services, we can offer you an extensive range of medical scales.

We will offer you reliable quality at fair prices and with the shortest delivery times. Our product specialists will give you professional advice, will work with you to find the right product and will provide comprehensive support after the purchase too.

This ensures a high level of investment security and a good feeling – KERN, the nice balance manufacturer from the wilds of Southern Germany.

For all details on our ranges, please see www.kern-sohn.com or request your own personal catalogues right now:
Telephone +49 7433 9933-0



*Jesús Martínez, product specialist
Medical scales*



“Medical products from KERN – products you can rely on”

For years an established name in hospitals, doctors' surgeries, rehabilitation clinics and nursing homes.

Wherever reliable quality is important, look no further than the complete KERN range of medical scales, from baby scales, to personal scales, chair scales, obesity scales through to hand grip dynamometers.

KERN 2021 catalogue for medical balances and devices – this is where you will find everything for day-to-day tasks in the medical environment!

Test weights

Weights yesterday and today

Weights have always been used to carry out weighing procedures. This original purpose has almost disappeared. Today, weights are used almost exclusively for adjusting and testing = calibration of electronic balances. We therefore call them "Test weights" as this is their purpose of use.

Adjustment or calibration?

► **Adjusting** a balance means that you are intervening in the weighing system, to make sure that the display is set to show the correct nominal value. With ► **calibration** on the other hand, there is no intervention, you are testing whether the display is correct and documenting any deviation.

Testing, the right way!

The internationally valid OIML norm R111:2004 classifies test weights hierarchically in accuracy classes, where E1 is the most accurate and M3 is the least accurate weight class. With KERN you get the whole test weight range in all OIML accuracy classes E1, E2, F1, F2, M1, M2, M3.

As the test weight only becomes an ► **ISO 9000ff**-compliant test instrument when its accuracy has been proven, we offer the appropriate ► **DAkKS-calibration certificate** or verification certificate (in connection with a box) for all KERN test weights. For further details, see the calibration service section on page 210.







KERN offers you the appropriate test weight package for your balance, consisting of the test weight, box and DAkKS-calibration certificate, as proof of its accuracy. The best prerequisite for a correct adjustment or checking of your scales.

► **See the glossary on page 223–225**

Test weights: classes of accuracy E, F, M and their general relation to the types of balances:

- E1 Test weights for customers who require a high degree of accuracy for the most demanding applications. For high-resolution balances with $d > 1,000,000$ Use recommended with DAkKS calibration certificate only.
- E2 Most accurate test weights for high resolution analytical balances of verification class I $\geq 100,000$ e
- F1 Test weights for analytical balances/precision balances for verification class I/II $\leq 100,000$ e
- F2 Test weights for precision balances of verification class II $\leq 30,000$ e
- M1 Test weights for industrial and commercial scales of verification class III $\leq 10,000$ e

The appropriate test weight for your new KERN balance can also be found directly in the accessories of the balance in our webshop.

KERN DAkKS delivery times & shipping type	Total weight ≤ 30 kg (gross weight, incl. packaging)	Total weight > 30 kg (gross weight, incl. packaging)
DAkKS standard service Class E2 – M3	 4 DAYS	 4 DAYS
DAkKS standard service Class E1, 1 mg – 500 mg and recalibration 1 g – 10 kg with a known volume	 10 DAYS	 10 DAYS
Class E1, ≥ 1 g, incl. volume determination (new weights)	 15 DAYS	 15 DAYS
Special weights, Newton weights, heavy duty weights, weight carriers, containers for individual weight sets etc.	on request	

Just lean back – we have just the right test weight for your measuring device

KERN offers you a large range of OIML test weights, which you can use at any time to quickly and reliably check your balance, force-measuring device, etc.. From milligram weights to tonne weights, from the classic OIML design to special weights which are specifically manufactured to your specifications, we can offer you just the right test weight, and naturally the weights have the relevant DAkkS calibration certificate or factory calibration certificate.

On the following pages you will see a selection of standard test weights for OIML error limit classes E1, E2, F1, F2, M1, M2, M3.

We will be happy to manufacture special (large) weights, weight containers, Newton weights or weights with special weight values for you on request. Our test weights product specialist will be happy to give you expert, comprehensive advice.

Note: In our webshop you can conveniently select test weights for your scale that have been calculated and matched to your accuracy requirements and intended use - with or without calibration. We will be happy to determine the minimum sample quantity according to USP Chapter <41> and recommend a KERN Safety Set especially designed for your scale.



PREMIUM⁺ TEST WEIGHTS

Note: Our highly-accurate OIML test weights are also available as **PREMIUM⁺ test weights** for that extra level of safety. Thanks to the most modern manufacturing technology, these test weights can also be adjusted within the specified error limit classes (= tolerances).

I.e. this means that these **PREMIUM⁺ test weights** have a significantly longer service life, thanks to this guaranteed positive tolerance. This is of particular benefit with intensive use of the test weights.

For all the details on this **PREMIUM⁺ service** please see www.kern-lab.com/premium+ or look at the weight you want in our online shop at www.kern-sohn.com

Marking – never lose track again!

With the large variety of test equipment used then it is essential that they are identified accurately. We can help you with this and can mark or etch your test weights to your specifications. Whether it's letters, numbers, your logo, barcodes or something else - it's your choice. Our product specialist "Test weights" will gladly help you with any questions about this service, prices, etc.





KERN SAFETY SETS

All the security you need!

„KERN Safety Sets“ which have been specially developed, put together and contain the right test weights to test and monitor your balance. This “KERN Safety Set” contains one test weight for testing the upper end of the weighing range of your balance and one test weight for testing the lower end. As an option, the “KERN Safety Set” has space for another test weight, for testing your balance at a weight which is relevant for you.

Useful accessories which have been selected to suit that particular “KERN Safety Set”, such as, for example, special gloves, tweezers, weight grips, brushes, etc. will assist you in handling your test weights properly. Stored in the practical protective case next to your balance, you can check and ensure the high precision of your balance at any time.

Just ask our test weight product specialist, he will be happy to recommend the right “KERN Safety Set” for your balance. You can also find the matching “KERN Safety Set” for each model on the Internet at www.kern-sohn.com

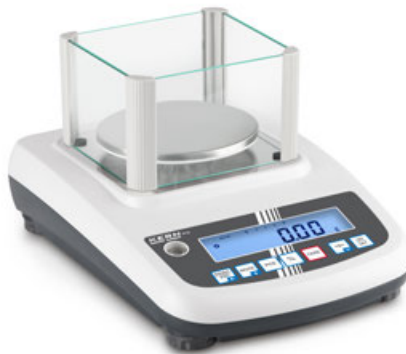

Our KERN weight cases at a glance:



It's your choice!

To protect your test weights we can offer you an appropriate weight case. If there are no legal or normative specifications, then you have the choice between plastic, aluminium protected or wood. The available weight cases are shown as a symbol in the test weight tables on the following pages. In this way you have all the materials, versions, sizes and prices at a glance, listed in a concise way.

It's so easy to order your suitable test weight

1. According to your safety requirements or the specifications of your QM system, you select the test weight with the appropriate weight value and the required tolerance.
2. We offer many test weights in different designs, giving you complete freedom to decide which test weights you want to use for your application. It goes without saying that all our test weights comply with the OIML R111:2004 directive.
3. To protect your high-quality test equipment, we offer you cases in various designs. From low-priced plastic weight cases to aluminium protected weight cases to classic, high-quality wooden weight cases.
4. A DAkkS calibration certificate - the auditor's favourite! With this certificate you provide the standard-compliant proof of all important values of your test equipment and are on the safe side when operating and testing your measuring equipment.

Weight	Tol +/- mg	Individual weights, compact shape		Individual weights, knob shape		Plastic box		Aluminium protected box		Wooden box		DAkkS certificate	
		KERN	€	KERN	€	KERN	€	KERN	€	KERN	€	KERN	€
1 g	0,03	316-01	32,-	317-01	49,-	317-020-400	4,-	317-010-600	14,-	317-010-100	26,-	962-331	27,-
2 g	0,04	316-02	34,-	317-02	53,-	317-020-400	4,-	317-020-600	14,-	317-020-100	26,-	962-332	27,-
5 g	0,05	316-03	36,-	317-03	56,-	317-030-400	4,-	317-030-600	14,-	317-030-100	26,-	962-333	27,-
10 g	0,06	316-04	38,-	317-04	60,-	317-040-400	4,-	317-040-600	14,-				27,-
20 g	0,08	316-05	43,-	317-05	68,-	317-050-400	4,-						
		316-06	46,-	317-06	73,-								

Weight sets	ECO shape in plastic case		ECO shape in aluminium protected case		ECO shape in wooden case		DAkkS certificate	
	KERN	€	KERN	€	KERN	€	KERN	€
1 mg - 500 mg	328-22*	184,-	328-226**	195,-	328-22*	184,-	962-450	100,-
1 mg - 50 g	325-024	500,-	325-026	405,-	325-022	450,-	962-401	167,-
1 mg - 100 g	325-034	560,-	325-036	410,-	325-032	480,-	962-402	178,-
1 mg - 200 g	325-044	670,-	325-046	530,-	325-042	585,-	962-403	199,-
1 mg - 500 g	325-054	580,-	325-056					

Selection of the appropriate test weight for your balance

A balance can never be more accurate than the test weight used to adjust it, it all depends on its tolerance. The accuracy of the test weight should correspond to the readout [d] of the balance, or rather be better. Nominal weight value is shown in adjust mode "CAL" in the balance display. Given a choice, the heaviest weight is the most suitable for accurate measurement.

Once accuracy and nominal weight value are specified, the suitable test weight is selected according to the tolerances "Tol" of the individual accuracy classes E2 - M3, see column "Tol ± mg" at the respective weight and table at page 188.

Example:

Balance with weighing range [Max] 2000 g = 2 kg
and readout [d] = 0,01 g = 10 mg

- The accuracy of the required test weight is determined by readout [d]: max. tolerance ± 10 mg.
- Displayed weight size on "CAL" mode: 1000 g or 2000 g. The required test weight has a 2 kg weight size.
- Suitable test weights with ± 10 mg tolerance and 2 kg weight size, can be found in accuracy class F1. KERN-No 326-12, see page 194.

Exception, analytical balances (readout [d] ≤ 0,1 mg):

E1 test weights are recommended. Depending on the safety requirements, E2 test weights with a DAkkS calibration certificate will also be sufficient.

From brass to stainless steel - the right test weight for every situation



Test weight →	Knob shape with lifting knob, polished stainless steel	Compact shape with carrying grip, polished stainless steel	Knob shape with lifting knob, polished stainless steel	ECO shape, polished stainless steel	Knob shape with lifting knob, finely turned stainless steel	Knob shape with lifting knob, finely turned brass
Features ↓						
Conforms to OIML:R111	yes	yes	yes	yes	yes	yes
Available classes	E1, E2	E2	F1	F1	F2, M1	M1, M2, M3
Upper surface	polished	polished	polished	polished	finely turned	finely turned
Material	Stainless steel	Stainless steel	Stainless steel	Stainless steel	Stainless steel	Brass
Adjusting cavity	no	no	yes	yes, from 50 g, readjustment can only be carried out by KERN	yes, from 20 g	yes, from 20 g
Marking (Milligram weights, generally none)	no	none	Nominal value, etched	Nominal value, etched	F2: Class + nominal value, etched; M1: Class + nominal value, adopted	Class + nominal value, adopted
Verification possible	yes	yes	yes	no	yes	yes, M1 only
Checking equipment for verification purposes	approved	approved	approved	approved	approved	approved, M1 only
Ideal as checking equipment in QM systems (e.g. ISO 9000 ff)	yes	yes	yes	yes	yes	yes
Benefits	<ul style="list-style-type: none"> • High-quality test weight for analytical and precision balances • Highly-refined surface • Ideal shape of the top for good grip 	<ul style="list-style-type: none"> • Affordable test weight for analytical and precision balances • Highly refined surface 	<ul style="list-style-type: none"> • Ideal, high-quality test weight for precision balances • No visible adjustment chamber • High long-term stability • Ideal shape of the top for good grip 	<ul style="list-style-type: none"> • Affordable test weight for analytical and precision balances • Highly refined surface • Optimum shape of the top for good grip 	<ul style="list-style-type: none"> • Ideal test weight for commercial and industrial scales • Ideal shape of the top for good grip 	<ul style="list-style-type: none"> • Affordable test weight for commercial and industrial scales • Ideal shape of the top for good grip

Composition table, valid for all KERN test weight sets from 1 mg

Individual weights per set →	1	2	2	5	10	20	20	50	100	200	200	500	1	2	2	5	10	10	20	20	50	100	200	200	500	1	2	2	5	10	
Test weight set ↓	mg	mg	mg	mg	mg	mg	mg	mg	mg	mg	mg	mg	g	g	g	g	g	g	g	g	g	g	g	g	g	g	kg	kg	kg	kg	kg
1 mg-500 mg	Total weight												1,11 g																		
1 mg-50 g													111,11 g																		
1 mg-100 g													211,11 g																		
1 mg-200 g													611,11 g																		
1 mg-500 g													1.111,11 g																		
1 mg-1 kg													2.111,11 g																		
1 mg-2 kg													6.111,11 g																		
1 mg-5 kg													11.111,11 g																		
1 mg-10 kg													21.111,11 g																		

The key points from the OIML norm R111:2004

OIML (Organisation Internationale de Metrologie Legale) has established the exact metrological requirements for weights in verified applications in approx. 100 states all over the world. The OIML recommendation R111 (2004 Edition) for weights relates to sizes 1 mg – 5000 kg. Statements are made on the accuracy, materials, geometric shape, marking and storage of the weights.

Error limits for weights of classes E1 to M3

The error limit classes are in fixed hierarchical levels in the proportion of 1:3, where E1 is the most accurate and M3 is the least accurate weight class. When testing weights with other weights, the correct test class is the next highest class.

Error limit classes (= tolerances)

The values given in the table below (tolerances ± ... mg) are the respective permitted fabrication tolerances. They are to be equal to the ► **measuring uncertainty** of the weight, if no ► **DAkkS calibration certificate** is available.

Conventional mass

The problem is the air buoyancy, which makes the weight appear lighter. In order to avoid this “distortion” in daily use, all weights are adjusted to the unit specifications as given in R111, e.g. it is accepted that: material density of the weights is 8000 kg/m³, air density is 1.2 kg/m³ and measuring temperature is 20 °C.

KERN test weights: Unless otherwise specified, they conform to OIML R111:2004 in every detail.

► *See the glossary, page 223–225*

Nominal value ↓	OIML R111:2004 Maximum permissible errors for weights = permissible tolerances “Tol ± mg”						
	E1	E2	F1	F2	M1	M2	M3
1 mg	± 0,003 mg	± 0,006 mg	± 0,020 mg	± 0,06 mg	± 0,20 mg	-	-
2 mg	± 0,003 mg	± 0,006 mg	± 0,020 mg	± 0,06 mg	± 0,20 mg	-	-
5 mg	± 0,003 mg	± 0,006 mg	± 0,020 mg	± 0,06 mg	± 0,20 mg	-	-
10 mg	± 0,003 mg	± 0,008 mg	± 0,025 mg	± 0,08 mg	± 0,25 mg	-	-
20 mg	± 0,003 mg	± 0,010 mg	± 0,03 mg	± 0,10 mg	± 0,3 mg	-	-
50 mg	± 0,004 mg	± 0,012 mg	± 0,04 mg	± 0,12 mg	± 0,4 mg	-	-
100 mg	± 0,005 mg	± 0,016 mg	± 0,05 mg	± 0,16 mg	± 0,5 mg	± 1,6 mg	-
200 mg	± 0,006 mg	± 0,020 mg	± 0,06 mg	± 0,20 mg	± 0,6 mg	± 2,0 mg	-
500 mg	± 0,008 mg	± 0,025 mg	± 0,08 mg	± 0,25 mg	± 0,8 mg	± 2,5 mg	-
1 g	± 0,010 mg	± 0,03 mg	± 0,10 mg	± 0,3 mg	± 1,0 mg	± 3,0 mg	± 10 mg
2 g	± 0,012 mg	± 0,04 mg	± 0,12 mg	± 0,4 mg	± 1,2 mg	± 4,0 mg	± 12 mg
5 g	± 0,016 mg	± 0,05 mg	± 0,16 mg	± 0,5 mg	± 1,6 mg	± 5,0 mg	± 16 mg
10 g	± 0,020 mg	± 0,06 mg	± 0,20 mg	± 0,6 mg	± 2,0 mg	± 6,0 mg	± 20 mg
20 g	± 0,025 mg	± 0,08 mg	± 0,25 mg	± 0,8 mg	± 2,5 mg	± 8,0 mg	± 25 mg
50 g	± 0,03 mg	± 0,10 mg	± 0,3 mg	± 1,0 mg	± 3,0 mg	± 10 mg	± 30 mg
100 g	± 0,05 mg	± 0,16 mg	± 0,5 mg	± 1,6 mg	± 5,0 mg	± 16 mg	± 50 mg
200 g	± 0,10 mg	± 0,3 mg	± 1,0 mg	± 3,0 mg	± 10 mg	± 30 mg	± 100 mg
500 g	± 0,25 mg	± 0,8 mg	± 2,5 mg	± 8,0 mg	± 25 mg	± 80 mg	± 250 mg
1 kg	± 0,5 mg	± 1,6 mg	± 5,0 mg	± 16 mg	± 50 mg	± 160 mg	± 500 mg
2 kg	± 1,0 mg	± 3,0 mg	± 10 mg	± 30 mg	± 100 mg	± 300 mg	± 1 000 mg
5 kg	± 2,5 mg	± 8,0 mg	± 25 mg	± 80 mg	± 250 mg	± 800 mg	± 2 500 mg
10 kg	± 5,0 mg	± 16 mg	± 50 mg	± 160 mg	± 500 mg	± 1 600 mg	± 5 000 mg
20 kg	± 10 mg	± 30 mg	± 100 mg	± 300 mg	± 1 000 mg	± 3 000 mg	± 10 g
50 kg	± 25 mg	± 80 mg	± 250 mg	± 800 mg	± 2 500 mg	± 8 000 mg	± 25 g
100 kg	-	± 160 mg	± 500 mg	± 1 600 mg	± 5 000 mg	± 16 g	± 50 g
200 kg	-	± 300 mg	± 1 000 mg	± 3 000 mg	± 10 g	± 30 g	± 100 g
500 kg	-	± 800 mg	± 2 500 mg	± 8 000 mg	± 25 g	± 80 g	± 250 g
1 000 kg	-	± 1 600 mg	± 5 000 mg	± 16 g	± 50 g	± 160 g	± 500 g
2 000 kg	-	-	± 10 g	± 30 g	± 100 g	± 300 g	± 1 000 g
5 000 kg	-	-	± 25 g	± 80 g	± 250 g	± 800 g	± 2 500 g

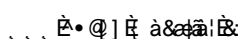

Test weights and boxes

Class E1



Milligram weights, wire shape



Individual weights, knob shape



Wooden box, for milligram weights



Plastic box, lined,
for individual weights
≤ 50 g



Plastic box, lined,
for individual weights
≥ 100 g



Wooden box, lined,
for individual weights ≤ 500 g



Wooden box, lined,
for individual weights ≥ 1 kg



Milligram weight set
in plastic box (308-
22)



Milligram weight
set in aluminium
protected box, lined
(308-226)



Aluminium protected case, lined, for weight
sets, knob shape



Wooden case, lined, for weight sets,
knob shape



Class E1 · Milligram weights, wire shape, stainless steel

Test weight material: stainless steel

Weight	Tol +/- mg	Milligram weight, wire shape		Plastic box		Aluminium protected box		Wooden box		DAkkS certificate	
		KERN	€	KERN	€	KERN	€	KERN	€	KERN	€
1 mg	0,003	308-31	58,-	347-009-400	2,-	317-009-600	15,-	338-090-200	19,-	962-251	57,-
2 mg	0,003	308-32	58,-	347-009-400	2,-	317-009-600	15,-	338-090-200	19,-	962-252	57,-
5 mg	0,003	308-33	58,-	347-009-400	2,-	317-009-600	15,-	338-090-200	19,-	962-253	57,-
10 mg	0,003	308-34	58,-	347-009-400	2,-	317-009-600	15,-	338-090-200	19,-	962-254	57,-
20 mg	0,003	308-35	58,-	347-009-400	2,-	317-009-600	15,-	338-090-200	19,-	962-255	57,-
50 mg	0,004	308-36	58,-	347-009-400	2,-	317-009-600	15,-	338-090-200	19,-	962-256	57,-
100 mg	0,005	308-37	58,-	347-009-400	2,-	317-009-600	15,-	338-090-200	19,-	962-257	57,-
200 mg	0,006	308-38	58,-	347-009-400	2,-	317-009-600	15,-	338-090-200	19,-	962-258	57,-
500 mg	0,008	308-39	58,-	347-009-400	2,-	317-009-600	15,-	338-090-200	19,-	962-259	57,-

Class E1 · Individual weights, knob shape, stainless steel polished

Test weight material: stainless steel polished

Weight	Tol +/- mg	Individual weight, knob shape		Plastic box		Aluminium protected box		Wooden box		DAkkS certificate Initial calibration*		DAkkS certificate Recalibration	
		KERN	€	KERN	€	KERN	€	KERN	€	KERN	€	KERN	€
1 g	0,010	307-01	87,-	317-020-400	4,-	317-010-600	14,-	317-010-100	26,-	963-231	210,-	962-231 R	57,-
2 g	0,012	307-02	95,-	317-020-400	4,-	317-020-600	14,-	317-020-100	26,-	963-232	210,-	962-232 R	57,-
5 g	0,016	307-03	98,-	317-030-400	4,-	317-030-600	14,-	317-030-100	26,-	963-233	210,-	962-233 R	57,-
10 g	0,020	307-04	106,-	317-040-400	4,-	317-040-600	14,-	317-040-100	26,-	963-234	210,-	962-234 R	57,-
20 g	0,025	307-05	113,-	317-050-400	4,-	317-050-600	14,-	317-050-100	26,-	963-335	210,-	962-235 R	57,-
50 g	0,030	307-06	135,-	317-060-400	5,-	317-060-600	14,-	317-060-100	27,-	963-236	210,-	962-236 R	57,-
100 g	0,050	307-07	170,-	317-070-400	5,-	317-070-600	14,-	317-070-100	29,-	963-237	210,-	962-237 R	57,-
200 g	0,100	307-08	210,-	317-080-400	6,-	317-080-600	14,-	317-080-100	29,-	963-238	210,-	962-238 R	57,-
500 g	0,250	307-09	280,-	317-090-400	7,-	317-090-600	15,-	317-090-100	30,-	963-239	210,-	962-239 R	57,-
1 kg	0,500	307-11	450,-	317-110-400	9,-	317-110-600	22,-	317-110-100	50,-	963-241	210,-	962-241 R	57,-
2 kg	1,000	307-12	630,-	317-120-400	12,-	317-120-600	26,-	317-120-100	58,-	963-242	465,-	962-242 R	70,-
5 kg	2,500	307-13	1060,-	317-130-400	20,-	317-130-600	44,-	317-130-100	86,-	963-243	465,-	962-243 R	70,-
10 kg	5,000	307-14	1620,-	317-140-400	20,-	317-140-600	62,-	317-140-100	97,-	963-244	465,-	962-244 R	70,-
20 kg	10,000	307-15	4200,-	-	-	317-150-600	110,-	317-150-100	550,-	963-245	1160,-	962-245 R	590,-
50 kg	25,000	307-16	8050,-	-	-	317-160-600	215,-	317-160-100	670,-	963-246	1360,-	962-246 R	660,-

* For E1 weights > 1g at the point of initial calibration, a volume determination will be carried out in accordance with OIML:R111. When recalibrating, this is not required.

Class E1 · Weight sets, knob shape, stainless steel polished

Test weight material: stainless steel polished

Plastic case *Aluminium protected case

Weight set	Aluminium protected case, knob shape		Wooden case, knob shape		DAkkS certificate Initial calibration*		DAkkS certificate Recalibration	
	KERN	€	KERN	€	KERN	€	KERN	€
1 mg - 500 mg	308-426***	780,-	308-42**	810,-	962-250	370,-	962-250 R	370,-
1 mg - 50 g	303-026	1570,-	303-02	1600,-	963-201	1180,-	962-201 R	610,-
1 mg - 100 g	303-036	1750,-	303-03	1780,-	963-202	1290,-	962-202 R	630,-
1 mg - 200 g	303-046	2160,-	303-04	2190,-	963-203	1490,-	962-203 R	690,-
1 mg - 500 g	303-056	2490,-	303-05	2520,-	963-204	1580,-	962-204 R	720,-
1 mg - 1 kg	303-066	2930,-	303-06	2990,-	963-205	1680,-	962-205 R	770,-
1 mg - 2 kg	303-076	4230,-	303-07	4290,-	963-206	2190,-	962-206 R	820,-
1 mg - 5 kg	303-086	5390,-	303-08	5490,-	963-207	2450,-	962-207 R	850,-
1 mg - 10 kg	303-096	7150,-	303-09	7250,-	963-208	2790,-	962-208 R	880,-
1 g - 50 g	304-026	920,-	304-02	950,-	963-215	850,-	962-215 R	270,-
1 g - 100 g	304-036	1090,-	304-03	1120,-	963-216	940,-	962-216 R	290,-
1 g - 200 g	304-046	1510,-	304-04	1540,-	963-217	1140,-	962-217 R	350,-
1 g - 500 g	304-056	1820,-	304-05	1850,-	963-218	1240,-	962-218 R	385,-
1 g - 1 kg	304-066	2230,-	304-06	2290,-	963-219	1350,-	962-219 R	410,-
1 g - 2 kg	304-076	3590,-	304-07	3650,-	963-220	1900,-	962-220 R	470,-
1 g - 5 kg	304-086	4690,-	304-08	4790,-	963-221	2230,-	962-221 R	495,-
1 g - 10 kg	304-096	6490,-	304-09	6590,-	963-222	2590,-	962-222 R	530,-

Test weights and boxes

Class E2



Milligram weights, flat polygonal sheet



Individual weights, compact shape



Individual weights, knob shape



Plastic box, lined, for individual weights ≤ 50 g



Plastic box, lined, for individual weights ≥ 100 g



Aluminium protected box, lined, for individual weights



Wooden box, lined, for individual weights ≤ 500 g



Wooden box, lined, for individual weights ≥ 1 kg



Milligram weight set in plastic box (318-22)



Milligram weight set in aluminium protected box, lined (318-226)



Plastic case, lined, for weight sets, compact shape/ knob shape





Aluminium protected case, lined, for weight sets, compact shape/ knob shape



Wooden case, lined, for weight sets, compact shape/ knob shape



Class E2 · Milligram weights, flat polygonal sheet, stainless steel

Test weight material: stainless steel

Weight	Tol +/- mg	Milligram weight, flat polygonal sheet		Plastic box		Aluminium protected box		Wooden box		DAkkS certificate	
		KERN	€	KERN 	€	KERN 	€	KERN 	€	KERN	€
1 mg	0,006	318-01	23,-	347-009-400	2,-	317-009-600	15,-	338-090-200	19,-	962-351	27,-
2 mg	0,006	318-02	23,-	347-009-400	2,-	317-009-600	15,-	338-090-200	19,-	962-352	27,-
5 mg	0,006	318-03	23,-	347-009-400	2,-	317-009-600	15,-	338-090-200	19,-	962-353	27,-
10 mg	0,008	318-04	23,-	347-009-400	2,-	317-009-600	15,-	338-090-200	19,-	962-354	27,-
20 mg	0,010	318-05	23,-	347-009-400	2,-	317-009-600	15,-	338-090-200	19,-	962-355	27,-
50 mg	0,012	318-06	23,-	347-009-400	2,-	317-009-600	15,-	338-090-200	19,-	962-356	27,-
100 mg	0,016	318-07	23,-	347-009-400	2,-	317-009-600	15,-	338-090-200	19,-	962-357	27,-
200 mg	0,020	318-08	23,-	347-009-400	2,-	317-009-600	15,-	338-090-200	19,-	962-358	27,-
500 mg	0,025	318-09	23,-	347-009-400	2,-	317-009-600	15,-	338-090-200	19,-	962-359	27,-

Class E2 · Individual weights, compact shape or knob shape, polished stainless steel





Test weight material: stainless steel polished

Weight	Tol +/- mg	Individual weights, compact shape		Individual weights, knob shape		Plastic box		Aluminium protected box		Wooden box		DAkkS certificate	
		KERN	€	KERN	€	KERN 	€	KERN 	€	KERN 	€	KERN	€
1 g	0,03	316-01	32,-	317-01	49,-	317-020-400	4,-	317-010-600	14,-	317-010-100	26,-	962-331	27,-
2 g	0,04	316-02	34,-	317-02	53,-	317-020-400	4,-	317-020-600	14,-	317-020-100	26,-	962-332	27,-
5 g	0,05	316-03	36,-	317-03	56,-	317-030-400	4,-	317-030-600	14,-	317-030-100	26,-	962-333	27,-
10 g	0,06	316-04	38,-	317-04	60,-	317-040-400	4,-	317-040-600	14,-	317-040-100	26,-	962-334	27,-
20 g	0,08	316-05	43,-	317-05	68,-	317-050-400	4,-	317-050-600	14,-	317-050-100	26,-	962-335	27,-
50 g	0,10	316-06	46,-	317-06	73,-	317-060-400	5,-	317-060-600	14,-	317-060-100	27,-	962-336	27,-
100 g	0,16	316-07	50,-	317-07	80,-	317-070-400	5,-	317-070-600	14,-	317-070-100	29,-	962-337	35,-
200 g	0,30	316-08	62,-	317-08	101,-	317-080-400	6,-	317-080-600	14,-	317-080-100	29,-	962-338	35,-
500 g	0,80	316-09	93,-	317-09	168,-	317-090-400	7,-	317-090-600	15,-	317-090-100	30,-	962-339	35,-
1 kg	1,60	316-11	135,-	317-11	245,-	317-110-400	9,-	317-110-600	22,-	317-110-100	50,-	962-341	35,-
2 kg	3,00	316-12	230,-	317-12	380,-	317-120-400	12,-	317-120-600	26,-	317-120-100	58,-	962-342	43,-
5 kg	8,00	316-13	360,-	317-13	550,-	317-130-400	20,-	317-130-600	44,-	317-130-100	86,-	962-343	43,-
10 kg	16,00	316-14	530,-	317-14	800,-	317-140-400	20,-	317-140-600	62,-	317-140-100	97,-	962-344	43,-
20 kg	30,00	-	-	317-15	2280,-	-	-	317-150-600	110,-	317-150-100	550,-	962-345	55,-
50 kg	80,00	-	-	317-16	4730,-	-	-	317-160-600	215,-	317-160-100	670,-	962-346	64,-

Class E2 · Weight sets, compact shape or knob shape, polished stainless steel

Test weight material: Milligram weights stainless steel, individual weights: polished stainless steel.

*Plastic case **Aluminium protected case

Weight sets	Compact shape in plastic case		Knob shape in plastic case		Knob shape in aluminium protected case		Knob shape in wooden case		DAkkS certificate	
	KERN 	€	KERN 	€	KERN 	€	KERN 	€	KERN	€
1 mg - 500 mg	318-22*	320,-	-	-	318-226**	330,-	-	-	962-350	190,-
1 mg - 50 g	-	-	313-024	830,-	313-026	850,-	313-02	880,-	962-301	315,-
1 mg - 100 g	-	-	313-034	900,-	313-036	920,-	313-03	960,-	962-302	340,-
1 mg - 200 g	-	-	313-044	1070,-	313-046	1090,-	313-04	1120,-	962-303	395,-
1 mg - 500 g	-	-	313-054	1230,-	313-056	1250,-	313-05	1340,-	962-304	420,-
1 mg - 1 kg	-	-	313-064	1520,-	313-066	1540,-	313-06	1600,-	962-305	450,-
1 mg - 2 kg	-	-	313-074	2330,-	313-076	2350,-	313-07	2410,-	962-306	495,-
1 mg - 5 kg	-	-	313-084	2880,-	313-086	2900,-	313-08	3060,-	962-307	530,-
1 mg - 10 kg	-	-	-	-	313-096	3800,-	313-09	3950,-	962-308	560,-
1 g - 50 g	312-024	355,-	314-024	550,-	314-026	570,-	314-02	590,-	962-315	129,-
1 g - 100 g	312-034	400,-	314-034	620,-	314-036	640,-	314-03	670,-	962-316	155,-
1 g - 200 g	312-044	500,-	314-044	790,-	314-046	810,-	314-04	840,-	962-317	205,-
1 g - 500 g	312-054	600,-	314-054	970,-	314-056	990,-	314-05	1050,-	962-318	230,-
1 g - 1 kg	312-064	790,-	314-064	1230,-	314-066	1250,-	314-06	1310,-	962-319	260,-
1 g - 2 kg	312-074	1220,-	314-074	2050,-	314-076	2070,-	314-07	2130,-	962-320	320,-
1 g - 5 kg	312-084	1560,-	314-084	2600,-	314-086	2620,-	314-08	2780,-	962-321	360,-
1 g - 10 kg	-	-	-	-	314-096	3490,-	314-09	3670,-	962-322	390,-

! Note

Our highly-accurate OIML test weights are also available as **Premium+** weights for that extra level of safety. See all details page 184 or on www.kern-lab.com/premium+

Test weights and boxes

Class F1



Milligram weights,
flat polygonal sheet



Individual weights/
Weight sets,
ECO shape



Individual weights/
Weight sets,
knob shape



Test weights (10 - 50 kg),
polished stainless steel, KERN
327-141 ff, optional: Wooden box



Block weight,
polished stainless steel



Plastic box,
lined, for
individual
weights
≤ 200 g



Plastic box,
lined, for
individual
weights
≥ 500 g



Aluminium protected box, lined,
for individual weights



Wooden box, lined,
for individual weights ≤ 500 g



Wooden box, lined,
for individual weights ≥ 1 kg



Milligram weight
set in plastic box
(328-22)



Milligram weight
set in aluminium
protected box,
lined
(328-226)



Plastic case, lined
for weight sets, knob shape



Aluminium protected case, lined,
for weight sets ECO shape/
knob shape



Wooden case, lined,
for weight sets ECO shape/
knob shape

Test weights class F1

Class F1 · Milligram weights, flat polygonal sheet, stainless steel

Test weight material: stainless steel

Weight	Tol +/- mg	Milligram weight, flat polygonal sheet		Plastic box		Aluminium protected box		Wooden box		DAkkS certificate	
		KERN	€	KERN	€	KERN	€	KERN	€	KERN	€
1 mg	0,020	328-01	11,-	347-009-400	2,-	317-009-600	15,-	338-090-200	19,-	962-451	18,-
2 mg	0,020	328-02	11,-	347-009-400	2,-	317-009-600	15,-	338-090-200	19,-	962-452	18,-
5 mg	0,020	328-03	11,-	347-009-400	2,-	317-009-600	15,-	338-090-200	19,-	962-453	18,-
10 mg	0,025	328-04	11,-	347-009-400	2,-	317-009-600	15,-	338-090-200	19,-	962-454	18,-
20 mg	0,03	328-05	11,-	347-009-400	2,-	317-009-600	15,-	338-090-200	19,-	962-455	18,-
50 mg	0,04	328-06	11,-	347-009-400	2,-	317-009-600	15,-	338-090-200	19,-	962-456	18,-
100 mg	0,05	328-07	11,-	347-009-400	2,-	317-009-600	15,-	338-090-200	19,-	962-457	18,-
200 mg	0,06	328-08	11,-	347-009-400	2,-	317-009-600	15,-	338-090-200	19,-	962-458	18,-
500 mg	0,08	328-09	11,-	347-009-400	2,-	317-009-600	15,-	338-090-200	19,-	962-459	18,-

Class F1 · Individual weights, ECO shape or knob shape, polished stainless steel

Test weight material: stainless steel polished

Weight	Tol +/- mg	Individual weight, ECO shape		Individual weight, knob shape		Plastic box		Aluminium protected box		Wooden box		DAkkS certificate	
		KERN	€	KERN	€	KERN	€	KERN	€	KERN	€	KERN	€
1 g	0,10	326-01	23,-	327-01	30,-	347-030-400	2,-	317-010-600	14,-	317-010-100	26,-	962-431	18,-
2 g	0,12	326-02	24,-	327-02	31,-	347-030-400	2,-	317-020-600	14,-	317-020-100	26,-	962-432	18,-
5 g	0,16	326-03	26,-	327-03	33,-	347-030-400	2,-	317-030-600	14,-	317-030-100	26,-	962-433	18,-
10 g	0,20	326-04	28,-	327-04	37,-	347-050-400	2,-	317-040-600	14,-	317-040-100	26,-	962-434	18,-
20 g	0,25	326-05	29,-	327-05	40,-	347-050-400	2,-	317-050-600	14,-	317-050-100	26,-	962-435	18,-
50 g	0,30	326-06	34,-	327-06	43,-	347-070-400	2,-	317-060-600	14,-	317-060-100	27,-	962-436	18,-
100 g	0,50	326-07	38,-	327-07	52,-	347-070-400	2,-	317-070-600	14,-	317-070-100	29,-	962-437	20,-
200 g	1,00	326-08	49,-	327-08	68,-	347-080-400	2,-	317-080-600	14,-	317-080-100	29,-	962-438	20,-
500 g	2,50	326-09	79,-	327-09	111,-	347-090-400	3,-	317-090-600	15,-	317-090-100	30,-	962-439	20,-
1 kg	5,00	326-11	104,-	327-11	154,-	347-110-400	3,-	317-110-600	22,-	317-110-100	50,-	962-441	20,-
2 kg	10	326-12	179,-	327-12	240,-	347-120-400	4,-	317-120-600	26,-	317-120-100	58,-	962-442	25,-
5 kg	25	326-13	260,-	327-13	355,-	347-130-400	9,-	317-130-600	44,-	317-130-100	86,-	962-443	25,-
10 kg	50	326-14	485,-	327-14	650,-	347-140-400	10,-	317-140-600	62,-	317-140-100	97,-	962-444	25,-
20 kg	100	-	-	327-15	1790,-	-	-	317-150-600	110,-	317-150-100	550,-	962-445	28,-
50 kg	250	-	-	327-16	3850,-	-	-	317-160-600	215,-	317-160-100	670,-	962-446	39,-

Class F1 · Block weights, stainless steel polished

Block weight material: stainless steel polished

Weight	Tol +/- mg	Dimensions ø × H	Block weight, stainless steel		Aluminium protected case		DAkkS certificate	
			KERN	€	KERN	€	KERN	€
5 kg	25	145×68×96	326-36	910,-	346-060-600	80,-	962-443	25,-
10 kg	50	193×96×117	326-37	1310,-	346-070-600	100,-	962-444	25,-
20 kg	100	233×115×145	326-38	1730,-	346-080-600	130,-	962-445	28,-
50 kg	250	295×158×191	326-39	4290,-	346-090-600	180,-	962-446	39,-

Class F1 · Test weights, stainless steel polished, stackable

Test weight material: stainless steel polished

Weight	Tol +/- mg	Test weight, stainless steel		Wooden case		DAkkS certificate	
		KERN	€	KERN	€	KERN	€
10 kg	50	327-141	570,-	337-141-100	340,-	962-444	25,-
20 kg	100	327-151	720,-	337-151-100	370,-	962-445	28,-
50 kg	250	327-161	1820,-	337-161-100	570,-	962-446	39,-

Class F1 · Weight sets, ECO shape, polished stainless steel

Test weight material: Milligramm weights stainless steel, Individual weights: polished stainless steel.

*Plastic case **Aluminium protected case

Weight sets	ECO shape in plastic case		ECO shape in aluminium protected case		ECO shape in wooden case		DAkkS certificate	
	KERN	€	KERN	€	KERN	€	KERN	€
1 mg - 500 mg	328-22*	184,-	328-226**	195,-	328-22*	184,-	962-450	100,-
1 mg - 50 g	325-024	395,-	325-026	405,-	325-022	450,-	962-401	167,-
1 mg - 100 g	325-034	430,-	325-036	440,-	325-032	480,-	962-402	178,-
1 mg - 200 g	325-044	520,-	325-046	530,-	325-042	570,-	962-403	199,-
1 mg - 500 g	325-054	580,-	325-056	610,-	325-052	690,-	962-404	210,-
1 mg - 1 kg	325-064	760,-	325-066	770,-	325-062	780,-	962-405	220,-
1 mg - 2 kg	325-074	1010,-	325-076	1080,-	325-072	1110,-	962-406	250,-
1 mg - 5 kg	325-084	1250,-	325-086	1350,-	325-082	1460,-	962-407	265,-
1 mg - 10 kg	-	-	325-096	1950,-	325-092	1980,-	962-408	285,-
1 g - 50 g	326-024	235,-	326-026	240,-	326-022	290,-	962-415	67,-
1 g - 100 g	326-034	270,-	326-036	290,-	326-032	330,-	962-416	77,-
1 g - 200 g	326-044	355,-	326-046	390,-	326-042	425,-	962-417	98,-
1 g - 500 g	326-054	420,-	326-056	490,-	326-052	550,-	962-418	109,-
1 g - 1 kg	326-064	600,-	326-066	620,-	326-062	660,-	962-419	119,-
1 g - 2 kg	326-074	850,-	326-076	920,-	326-072	1020,-	962-420	151,-
1 g - 5 kg	326-084	1090,-	326-086	1190,-	326-082	1400,-	962-421	166,-
1 g - 10 kg	-	-	326-096	1790,-	326-092	1840,-	962-422	182,-

Class F1 · Weight sets, knob shape, polished stainless steel

Test weight material: Milligramm weights stainless steel, Individual weights: polished stainless steel.

*Plastic case **Aluminium protected case

Weight sets	Knob shape in plastic case		Knob shape in aluminium protected case		Knob shape in wooden case		DAkkS certificate	
	KERN	€	KERN	€	KERN	€	KERN	€
1 mg - 500 mg	328-22*	184,-	328-226**	195,-	328-22*	184,-	962-450	100,-
1 mg - 50 g	323-024	500,-	323-026	520,-	323-02	550,-	962-401	167,-
1 mg - 100 g	323-034	560,-	323-036	580,-	323-03	600,-	962-402	178,-
1 mg - 200 g	323-044	670,-	323-046	690,-	323-04	710,-	962-403	199,-
1 mg - 500 g	323-054	780,-	323-056	830,-	323-05	880,-	962-404	210,-
1 mg - 1 kg	323-064	1000,-	323-066	1020,-	323-06	1040,-	962-405	220,-
1 mg - 2 kg	323-074	1490,-	323-076	1510,-	323-07	1570,-	962-406	250,-
1 mg - 5 kg	323-084	1830,-	323-086	1870,-	323-08	2010,-	962-407	265,-
1 mg - 10 kg	-	-	323-096	2650,-	323-09	2750,-	962-408	285,-
1 g - 50 g	324-024	345,-	324-026	370,-	324-02	400,-	962-415	67,-
1 g - 100 g	324-034	405,-	324-036	425,-	324-03	455,-	962-416	77,-
1 g - 200 g	324-044	520,-	324-046	540,-	324-04	570,-	962-417	98,-
1 g - 500 g	324-054	630,-	324-056	670,-	324-05	720,-	962-418	109,-
1 g - 1 kg	324-064	850,-	324-066	870,-	324-06	890,-	962-419	119,-
1 g - 2 kg	324-074	1340,-	324-076	1370,-	324-07	1410,-	962-420	151,-
1 g - 5 kg	324-084	1680,-	324-086	1760,-	324-08	1870,-	962-421	166,-
1 g - 10 kg	-	-	324-096	2510,-	324-09	2600,-	962-422	182,-

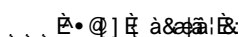

Test weights and boxes

Class F2



Milligram weights, flat polygonal sheet



Individual weights/Weight sets, knob shape



Block weight, stainless steel



Test weights (10 – 50 kg), finely turned stainless steel KERN 337-141 ff, optional: Wooden box



Plastic box, lined, for individual weights ≤ 200 g

Plastic box, lined, for individual weights ≥ 500 g



Aluminium protected box, lined, for individual weights



Wooden box, not lined for individual weights ≤ 500 g



Wooden box, not lined, for individual weights ≥ 1 kg



Milligram weight set in plastic box (338-22)



Milligram weight set in aluminium protected box, lined (338-226)



Plastic case, lined, for weight sets knob shape



Aluminium protected case, lined, for weight sets knob shape





Wooden case, for weight sets knob shape

Test weights class F2



Class F2 · Milligram weights, flat polygonal sheet, stainless steel

Test weight material: stainless steel

Weight	Tol +/- mg	Milligram weight, flat polygonal sheet		Plastic box		Aluminium protected box		Wooden box		DAkkS certificate	
		KERN	€	KERN 	€	KERN 	€	KERN 	€	KERN	€
1 mg	0,06	338-01	9,-	347-009-400	2,-	317-009-600	15,-	338-090-200	19,-	962-451	18,-
2 mg	0,06	338-02	9,-	347-009-400	2,-	317-009-600	15,-	338-090-200	19,-	962-452	18,-
5 mg	0,06	338-03	9,-	347-009-400	2,-	317-009-600	15,-	338-090-200	19,-	962-453	18,-
10 mg	0,08	338-04	9,-	347-009-400	2,-	317-009-600	15,-	338-090-200	19,-	962-454	18,-
20 mg	0,10	338-05	9,-	347-009-400	2,-	317-009-600	15,-	338-090-200	19,-	962-455	18,-
50 mg	0,12	338-06	9,-	347-009-400	2,-	317-009-600	15,-	338-090-200	19,-	962-456	18,-
100 mg	0,16	338-07	9,-	347-009-400	2,-	317-009-600	15,-	338-090-200	19,-	962-457	18,-
200 mg	0,20	338-08	9,-	347-009-400	2,-	317-009-600	15,-	338-090-200	19,-	962-458	18,-
500 mg	0,25	338-09	9,-	347-009-400	2,-	317-009-600	15,-	338-090-200	19,-	962-459	18,-

Class F2 · Individual weights, knob shape, finely turned stainless steel

Test weight material: finely turned polished

Weight	Tol +/- mg	Individual weight, knob shape		Plastic box		Aluminium protected box		Wooden box		DAkkS certificate	
		KERN	€	KERN 	€	KERN 	€	KERN 	€	KERN	€
1 g	0,3	337-01	19,-	347-030-400	2,-	317-010-600	14,-	337-010-200	17,-	962-431	18,-
2 g	0,4	337-02	20,-	347-030-400	2,-	317-020-600	14,-	337-020-200	17,-	962-432	18,-
5 g	0,5	337-03	21,-	347-030-400	2,-	317-030-600	14,-	337-030-200	18,-	962-433	18,-
10 g	0,6	337-04	23,-	347-050-400	2,-	317-040-600	14,-	337-040-200	18,-	962-434	18,-
20 g	0,8	337-05	25,-	347-050-400	2,-	317-050-600	14,-	337-050-200	18,-	962-435	18,-
50 g	1,0	337-06	27,-	347-070-400	2,-	317-060-600	14,-	337-060-200	18,-	962-436	18,-
100 g	1,6	337-07	30,-	347-070-400	2,-	317-070-600	14,-	337-070-200	20,-	962-437	20,-
200 g	3,0	337-08	40,-	347-080-400	2,-	317-080-600	14,-	337-080-200	20,-	962-438	20,-
500 g	8,0	337-09	57,-	347-090-400	3,-	317-090-600	14,-	337-090-200	22,-	962-439	20,-
1 kg	16	337-11	80,-	347-110-400	3,-	317-110-600	22,-	337-110-200	36,-	962-441	20,-
2 kg	30	337-12	120,-	347-120-400	4,-	317-120-600	26,-	337-120-200	36,-	962-442	25,-
5 kg	80	337-13	205,-	347-130-400	9,-	317-130-600	44,-	337-130-200	60,-	962-443	25,-
10 kg	160	337-14	395,-	347-140-400	9,-	317-140-600	62,-	337-140-200	63,-	962-444	25,-
20 kg	300	337-15	690,-	-	-	317-150-600	110,-	337-150-200	360,-	962-445	28,-
50 kg	800	337-16	1240,-	-	-	317-160-600	215,-	337-160-200	560,-	962-446	39,-

Class F2 · Test weights, finely turned stainless steel

Test weight material: finely turned stainless steel

Weight	Tol +/- mg	Test weight, stainless steel		Wooden box		DAkkS certificate	
		KERN	€	KERN 	€	KERN	€
10 kg	160	337-141	600,-	337-141-200	335,-	962-444	25,-
20 kg	300	337-151	730,-	337-151-200	360,-	962-445	28,-
50 kg	800	337-161	1970,-	337-161-200	560,-	962-446	39,-

Class F2 · Block weights, stainless steel glass bead blasted

Block weight material: stainless steel glass bead blasted



Weight	Tol +/- mg	Block weight, stainless steel		Aluminium protected case		DAkkS certificate	
		KERN	€	KERN 	€	KERN	€
5 kg	80	336-36	510,-	346-060-600	80,-	962-443	25,-
10 kg	160	336-37	680,-	346-070-600	100,-	962-444	25,-
20 kg	300	336-38	860,-	346-080-600	130,-	962-445	28,-
50 kg	800	336-39	2280,-	346-090-600	180,-	962-446	39,-

Class F2 · Weight sets, knob shape, finely turned stainless steel

Test weight material: Milligramm weights stainless steel, individual weights stainless steel.

*Plastic case

**Aluminium protected case

Weight	Knob shape in plastic case		Knob shape in aluminium protected case		Knob shape in wooden case		DAkkS certificate	
	KERN 	€	KERN 	€	KERN 	€	KERN	€
1 mg - 500 mg	338-22*	143,-	338-226**	183,-	338-22*	143,-	962-450	100,-
1 mg - 50 g	333-024	345,-	333-026	365,-	333-02	370,-	962-401	167,-
1 mg - 100 g	333-034	385,-	333-036	400,-	333-03	405,-	962-402	178,-
1 mg - 200 g	333-044	450,-	333-046	465,-	333-04	470,-	962-403	199,-
1 mg - 500 g	333-054	510,-	333-056	530,-	333-05	540,-	962-404	210,-
1 mg - 1 kg	333-064	630,-	333-066	650,-	333-06	660,-	962-405	220,-
1 mg - 2 kg	333-074	890,-	333-076	910,-	333-07	920,-	962-406	250,-
1 mg - 5 kg	333-084	1150,-	333-086	1180,-	333-08	1190,-	962-407	265,-
1 mg - 10 kg	-	-	333-096	1640,-	333-09	1650,-	962-408	285,-
1 g - 50 g	334-024	220,-	334-026	235,-	334-02	240,-	962-415	67,-
1 g - 100 g	334-034	260,-	334-036	270,-	334-03	275,-	962-416	77,-
1 g - 200 g	334-044	345,-	334-046	365,-	334-04	370,-	962-417	98,-
1 g - 500 g	334-054	410,-	334-056	425,-	334-05	430,-	962-418	109,-
1 g - 1 kg	334-064	520,-	334-066	530,-	334-06	540,-	962-419	119,-
1 g - 2 kg	334-074	760,-	334-076	800,-	334-07	810,-	962-420	151,-
1 g - 5 kg	334-084	990,-	334-086	1060,-	334-08	1070,-	962-421	166,-
1 g - 10 kg	-	-	334-096	1520,-	334-09	1530,-	962-422	182,-

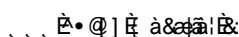

Test weights and boxes

Class M1



Milligram weights, flat polygonal sheet



Individual weights/Weight sets, knob shape, finely turned stainless steel or finely turned brass



Hook weights, finely turned brass (stainless steel, on request)



Slotted weights, finely turned brass or finely turned stainless steel (on request)



Plastic box, for individual weights ≤ 200 g, for hook weights and slotted weights ≤ 50 g



Plastic box, lined, for individual weights ≥ 500 g, for hook weights and slotted weights ≥ 100 g



Aluminium protected box, lined, for individual weights



Wooden box, not lined, for individual weights ≤ 500 g



Wooden box, not lined, for individual weights ≥ 1 kg



Milligram weight set in plastic box (348-22)



Milligram weight set in aluminium protected box, lined (348-226)



Plastic case, lined, for weight sets, knob shape, stainless steel or finely turned brass



Aluminium protected case, lined, for weight sets, knob shape, stainless steel or finely turned brass



Wooden case, for weight sets, knob shape, stainless steel or finely turned brass



Test weights (10 - 50 kg), finely turned stainless steel KERN 347-141 ff, optional: Wooden box



Beam bars, for fixing slotted weights, aluminium or finely turned brass

* | ** | *** see page 202



Block weights, lacquered cast iron/stainless steel, optional: Aluminium protected case, lined



Test weights class M1

Class M1 · Milligram weights, flat polygonal sheet, stainless steel

Test weight material: stainless steel

Weight	Tol +/- mg	Milligram weight, flat polygonal sheet		Plastic box		Aluminium protected box		Wooden box		DAkkS certificate	
		KERN	€	KERN	€	KERN	€	KERN	€	KERN	€
1 mg	0,20	348-01	3,90	347-009-400	2,-	317-009-600	15,-	338-090-200	19,-	962-651	15,-
2 mg	0,20	348-02	3,90	347-009-400	2,-	317-009-600	15,-	338-090-200	19,-	962-652	15,-
5 mg	0,20	348-03	3,90	347-009-400	2,-	317-009-600	15,-	338-090-200	19,-	962-653	15,-
10 mg	0,25	348-04	3,90	347-009-400	2,-	317-009-600	15,-	338-090-200	19,-	962-654	15,-
20 mg	0,30	348-05	3,90	347-009-400	2,-	317-009-600	15,-	338-090-200	19,-	962-655	15,-
50 mg	0,40	348-06	3,90	347-009-400	2,-	317-009-600	15,-	338-090-200	19,-	962-656	15,-
100 mg	0,50	348-07	3,90	347-009-400	2,-	317-009-600	15,-	338-090-200	19,-	962-657	15,-
200 mg	0,60	348-08	3,90	347-009-400	2,-	317-009-600	15,-	338-090-200	19,-	962-658	15,-
500 mg	0,80	348-09	3,90	347-009-400	2,-	317-009-600	15,-	338-090-200	19,-	962-659	15,-

Class M1 · Individual weights, knob shape, finely turned brass or stainless steel

Test weights material: 347-41 - 347-54 finely turned brass, 347-01 - 347-14 stainless steel

Weight	Tol +/- mg	Individual weight, brass*		Individual weight, stainless steel		Plastic box		Aluminium protected box		Wooden box		DAkkS certificate	
		KERN	€	KERN	€	KERN	€	KERN	€	KERN	€	KERN	€
1 g	1,0	347-41	4,70	347-01	4,60	347-030-400	2,-	317-010-600	14,-	337-010-200	17,-	962-631	15,-
2 g	1,2	347-42	5,00	347-02	4,90	347-030-400	2,-	317-020-600	14,-	337-020-200	17,-	962-632	15,-
5 g	1,6	347-43	5,30	347-03	5,20	347-030-400	2,-	317-030-600	14,-	337-030-200	18,-	962-633	15,-
10 g	2,0	347-44	5,70	347-04	5,60	347-050-400	2,-	317-040-600	14,-	337-040-200	18,-	962-634	15,-
20 g	2,5	347-45	8,00	347-05	7,20	347-050-400	2,-	317-050-600	14,-	337-050-200	18,-	962-635	15,-
50 g	3,0	347-46	9,40	347-06	9,00	347-070-400	2,-	317-060-600	14,-	337-060-200	18,-	962-636	15,-
100 g	5,0	347-47	12,-	347-07	11,-	347-070-400	2,-	317-070-600	14,-	337-070-200	20,-	962-637	16,-
200 g	10	347-48	17,-	347-08	15,-	347-080-400	2,-	317-080-600	14,-	337-080-200	20,-	962-638	16,-
500 g	25	347-49	31,-	347-09	30,-	347-090-400	3,-	317-090-600	15,-	337-090-200	22,-	962-639	16,-
1 kg	50	347-51	47,-	347-11	45,-	347-110-400	3,-	317-110-600	22,-	337-110-200	36,-	962-641	16,-
2 kg	100	347-52	84,-	347-12	82,-	347-120-400	4,-	317-120-600	26,-	337-120-200	36,-	962-642	17,-
5 kg	250	347-53	190,-	347-13	180,-	347-130-400	9,-	317-130-600	44,-	337-130-200	60,-	962-643	17,-
10 kg	500	347-54	360,-	347-14	350,-	347-140-400	10,-	317-140-600	62,-	337-140-200	63,-	962-644	17,-

*Material brass - only while stocks last! (Alternatively: stainless steel)

Class M1 · Block weights, lacquered cast iron or stainless steel

Block weight material: cast iron or stainless steel, surface and edges refined

Weight	Tol +/- g	Block weight, cast iron		Block weight, stainless steel		Aluminium protected case		DAkkS certificate	
		KERN	€	KERN	€	KERN	€	KERN	€
5 kg	0,25	346-86	54,-	346-06	380,-	346-060-600	80,-	962-643	17,-
10 kg	0,50	346-87	90,-	346-07	510,-	346-070-600	100,-	962-644	17,-
20 kg	1,00	346-88	158,-	346-08	680,-	346-080-600	130,-	962-645	22,-
50 kg	2,50	346-89	395,-	346-09	1820,-	346-090-600	180,-	962-646	24,-

Class M1 · ECO Block weights, lacquered cast iron

ECO Block weight material: cast iron, surface and edges machined

Weight	Tol +/- g	ECO Block weight, cast iron		Aluminium protected case		DAkkS certificate	
		KERN	€	KERN	€	KERN	€
5 kg	0,25	346-76	45,-	346-060-600	80,-	962-643	17,-
10 kg	0,50	346-77	72,-	346-070-600	100,-	962-644	17,-
20 kg	1,00	346-78	125,-	346-080-600	130,-	962-645	22,-
50 kg	2,50	346-79	300,-	346-090-600	180,-	962-646	24,-

Test weights class M1

Class M1 · Test weights, stainless steel, stackable

Test weight material: finely turned stainless steel

Weight	Tol +/- g	Test weight, stainless steel		Wooden box		DAkkS certificate	
		KERN	€	KERN	€	KERN	€
10 kg	0,5	347-141	600,-	337-141-200	335,-	962-644	17,-
20 kg	1,0	347-151	740,-	337-151-200	360,-	962-645	22,-
50 kg	2,5	347-161	1970,-	337-161-200	560,-	962-646	24,-

Class M1 · Heavy duty weights, lacquered cast iron, stackable

Heavy duty weight material: cast iron

Designed to be lifted with forklift trucks or cranes, delivery time is approx. 4 weeks

Dimensions: see internet on www.kern-sohn.com

Weight	Tol +/- g	Heavy duty weight, cast iron		DAkkS certificate	
		KERN	€	KERN	€
100 kg	5	346-81	1880,-	962-691	63,-
200 kg	10	346-82	2390,-	962-692	63,-
500 kg	25	346-83	4470,-	962-693	63,-
1000 kg	50	346-84	7430,-	962-694	136,-
2000 kg	100	346-85	13790,-	962-695	250,-



! Note



We also offer a large range of heavy-duty weights in other materials, for example, stainless steel and in other forms, for example, discs or individual weight containers, please ask for details.

Class M1 · Weight sets, knob shape, finely turned brass or stainless steel

Test weight material: Milligramm weights stainless steel, individual weights finely turned brass or stainless steel.

*Plastic case

**Aluminium protected case

Weight	Knob shape, finely turned brass  , in plastic case		Knob shape, finely turned stainless steel, in plastic case		Knob shape, finely turned brass  , in wooden case		Knob shape, finely turned stainless steel, in wooden case		Knob shape, finely turned brass  , in aluminium protected case		Knob shape, finely turned stainless steel, in aluminium protected case		DAkkS certificate	
	KERN	€	KERN	€	KERN	€	KERN	€	KERN	€	KERN	€	KERN	€
1 mg - 500 mg	348-22*	83,-	348-22*	83,-	348-22*	83,-	348-22*	83,-	348-226**	130,-	348-226**	130,-	962-650	63,-
1 mg - 50 g	343-424	194,-	343-024	193,-	343-42	178,-	343-02	177,-	343-426	176,-	343-026	175,-	962-601	106,-
1 mg - 100 g	343-434	210,-	343-034	205,-	343-43	193,-	343-03	192,-	343-436	187,-	343-036	186,-	962-602	112,-
1 mg - 200 g	343-444	240,-	343-044	255,-	343-44	230,-	343-04	225,-	343-446	220,-	343-046	215,-	962-603	125,-
1 mg - 500 g	343-454	270,-	343-054	265,-	343-45	260,-	343-05	255,-	343-456	250,-	343-056	245,-	962-604	131,-
1 mg - 1 kg	343-464	420,-	343-064	415,-	343-46	405,-	343-06	395,-	343-466	330,-	343-066	320,-	962-605	137,-
1 mg - 2 kg	343-474	590,-	343-074	550,-	343-47	590,-	343-07	550,-	343-476	530,-	343-076	495,-	962-606	152,-
1 mg - 5 kg	343-484	770,-	343-084	700,-	343-48	810,-	343-08	760,-	343-486	760,-	343-086	680,-	962-607	160,-
1 mg - 10 kg	-	-	-	-	343-49	1230,-	343-09	1100,-	343-496	1190,-	343-096	1070,-	962-608	167,-
1 g - 50 g	344-424	128,-	344-024	127,-	344-42	124,-	344-02	123,-	344-426	122,-	344-026	121,-	962-615	42,-
1 g - 100 g	344-434	139,-	344-034	138,-	344-43	135,-	344-03	134,-	344-436	133,-	344-036	132,-	962-616	49,-
1 g - 200 g	344-444	169,-	344-044	168,-	344-44	165,-	344-04	163,-	344-446	162,-	344-046	161,-	962-617	61,-
1 g - 500 g	344-454	200,-	344-054	199,-	344-45	199,-	344-05	196,-	344-456	194,-	344-056	193,-	962-618	68,-
1 g - 1 kg	344-464	355,-	344-064	345,-	344-46	320,-	344-06	310,-	344-466	275,-	344-066	265,-	962-619	74,-
1 g - 2 kg	344-474	520,-	344-074	485,-	344-47	500,-	344-07	465,-	344-476	480,-	344-076	440,-	962-620	89,-
1 g - 5 kg	344-484	710,-	344-084	630,-	344-48	750,-	344-08	670,-	344-486	710,-	344-086	640,-	962-621	96,-
1 g - 10 kg	-	-	-	-	344-49	1170,-	344-09	1020,-	344-496	1140,-	344-096	1010,-	962-622	104,-

 Material brass - only while stocks last! (Alternatively: stainless steel)

Test weights class M1

Class M1 · Hook weights, finely turned brass

Hook weight material: finely turned brass

Weight	Tol +/- mg	Hook weight, brass		Plastic box, lined		DAkkS certificate	
		KERN	€	KERN	€	KERN	€
1 g	1,0	347-416	18,-	347-030-400	2,-	962-631	15,-
2 g	1,2	347-426	19,-	347-030-400	2,-	962-632	15,-
5 g	1,6	347-436	19,-	347-030-400	2,-	962-633	15,-
10 g	2,0	347-446	19,-	347-050-400	2,-	962-634	15,-
20 g	2,5	347-456	20,-	347-050-400	2,-	962-635	15,-
50 g	3,0	347-466	23,-	347-070-400	2,-	962-636	15,-
100 g	5,0	347-476	27,-	347-090-400	3,-	962-637	16,-
200 g	10,0	347-486	31,-	347-090-400	3,-	962-638	16,-
500 g	25,0	347-496	57,-	347-110-400	3,-	962-639	16,-
1 kg	50,0	347-516	82,-	347-120-400	4,-	962-641	16,-
2 kg	100,0	347-526	132,-	347-130-400	9,-	962-642	17,-
5 kg	250,0	347-536	245,-	347-140-400	10,-	962-643	17,-
10 kg	500,0	347-546	390,-	-	-	962-644	17,-

! Note



Stainless steel hook weights, on request

Class M1 · Slotted weights, finely turned brass

Slotted weight material: finely turned brass

Weight	Tol +/- mg	Slotted weight, brass		Plastic box, lined		DAkkS certificate	
		KERN	€	KERN	€	KERN	€
1 g	1,0	347-415	14,-	347-030-400	2,-	962-631	15,-
2 g	1,2	347-425	14,-	347-030-400	2,-	962-632	15,-
5 g	1,6	347-435	15,-	347-030-400	2,-	962-633	15,-
10 g	2,0	347-445	17,-	347-030-400	2,-	962-634	15,-
20 g	2,5	347-455	21,-	347-080-400	2,-	962-635	15,-
50 g	3,0	347-465	24,-	347-080-400	2,-	962-636	15,-
100 g	5,0	347-475	27,-	347-090-400	3,-	962-637	16,-
200 g	10	347-485	36,-	347-090-400	3,-	962-638	16,-
500 g	25	347-495	58,-	347-110-400	3,-	962-639	16,-
1 kg	50	347-515	90,-	347-130-400	9,-	962-641	16,-
2 kg	100	347-525	146,-	347-130-400	9,-	962-642	17,-
5 kg	250	347-535	230,-	347-140-400	10,-	962-643	17,-
10 kg	500	347-545	425,-	347-140-400	10,-	962-644	17,-

! Note



Stainless steel slotted weights, on request

Class M1 · Beam bars, for fixing slotted weights

Beam bars material: 10 g: aluminium, 100 g-1 kg: brass

Own weight beam bar	Maximum total load ⁽¹⁾	Largest slotted weight possible	Material	Length	Beam bar		DAkkS certificate	
					KERN	€	KERN	€
10 g	200 g	100 g	Aluminium	117,5	347-445-100*	30,-	962-634	15,-
100 g	2 kg	1 kg	Brass	238	347-475-100**	53,-	962-637	16,-
500 g	20 kg	10 kg	Brass	639	347-495-100***	77,-	962-639	16,-
1 kg	40 kg	10 kg	Brass	1020	347-515-100***	114,-	962-641	16,-

⁽¹⁾ is exclusive of the own weight of the beam bar, e.g. the maximum possible total weight is calculated from

"Maximum total load" + "own weight beam bar";

* | ** | *** see page 199

Newton weights (N)

All hook and slotted weights as well as beam bars are available with N adjustment according to M1 tolerances, additional price € 8,-/pc. We need to know the location of use and postal code.

DAkkS calibration certificate for N weights: identical to DAkkS prices for individual weights M1, additional price € 8,-.

Test weights and boxes

Classes M2 · M3



Individual weights/Weight sets,
knob shape, finely turned brass



Individual weights/Weight sets,
knob shape, lacquered cast iron



Block weights,
lacquered cast iron



Plastic box, lined,
for individual weights



Aluminium protected box,
lined, for individual weights



Wooden box, not lined, for
individual weights ≤ 500 g,
■ not appropriate for cast
iron weights



Wooden box, not lined, for
individual weights ≥ 1 kg,
■ not appropriate for cast
iron weights



Aluminium protected case,
lined, for block weights



Plastic case, lined, for weight sets
knob shape, stainless steel or
finely turned brass



Aluminium protected case, lined,
for weight sets knob shape, finely
turned brass, ■ not appropriate
for cast iron weights



Wooden case,
for weight sets knob shape,
finely turned brass







Wooden block,
for weight sets knob shape,
lacquered cast iron

Test weights classes M2

Class M2 · Individual weights, knob shape, finely turned brass

Test weight material: finely turned brass*

Weight	Tol +/- mg	Individual weight, knob shape		Plastic box, lined		Aluminium protected box		Wooden box		DAkkS certificate	
		KERN	€	KERN 	€	KERN 	€	KERN 	€	KERN	€
1 g	3	357-41	4,00	347-030-400	2,-	317-010-600	14,-	337-010-200	17,-	962-631	15,-
2 g	4	357-42	4,00	347-030-400	2,-	317-020-600	14,-	337-020-200	17,-	962-632	15,-
5 g	5	357-43	4,10	347-030-400	2,-	317-030-600	14,-	337-030-200	18,-	962-633	15,-
10 g	6	357-44	4,40	347-050-400	2,-	317-040-600	14,-	337-040-200	18,-	962-634	15,-
20 g	8	357-45	8,00	347-050-400	2,-	317-050-600	14,-	337-050-200	18,-	962-635	15,-
50 g	10	357-46	9,40	347-070-400	2,-	317-060-600	14,-	337-060-200	18,-	962-636	15,-
100 g	16	357-47	12,-	347-070-400	2,-	317-070-600	14,-	337-070-200	20,-	962-637	16,-
200 g	30	357-48	17,-	347-080-400	2,-	317-080-600	14,-	337-080-200	20,-	962-638	16,-
500 g	80	357-49	31,-	347-090-400	3,-	317-090-600	15,-	337-090-200	22,-	962-639	16,-
1 kg	160	357-51	46,-	347-110-400	3,-	317-110-600	22,-	337-110-200	36,-	962-641	16,-
2 kg	300	357-52	84,-	347-120-400	4,-	317-120-600	26,-	337-120-200	36,-	962-642	17,-
5 kg	800	357-53	183,-	347-130-400	9,-	317-130-600	44,-	337-130-200	60,-	962-643	17,-
10 kg	1600	357-54	360,-	347-140-400	10,-	317-140-600	62,-	337-140-200	63,-	962-644	17,-

 *Material brass – only while stocks last! (Alternatively: stainless steel)

Class M2 · Block weights, lacquered cast iron

Block weight material: cast iron, surface and edges refined

Weight	Tol +/- g	Block weight, cast iron		Aluminium protected box		DAkkS certificate	
		KERN	€	KERN 	€	KERN	€
5 kg	0,8	356-86	54,-	346-060-600	80,-	962-643	17,-
10 kg	1,6	356-87	90,-	346-070-600	100,-	962-644	17,-
20 kg	3,0	356-88	158,-	346-080-600	130,-	962-645	22,-
50 kg	8,0	356-89	395,-	346-090-600	180,-	962-646	24,-



Class M2 · ECO Block weights, lacquered cast iron

ECO Block weight material: lacquered cast iron, surface and edges refined

Weight	Tol +/- g	ECO block weight, cast iron		Aluminium protected box		DAkkS certificate	
		KERN	€	KERN 	€	KERN	€
5 kg	0,8	356-76	45,-	346-060-600	80,-	962-643	17,-
10 kg	1,6	356-77	72,-	346-070-600	100,-	962-644	17,-
20 kg	3,0	356-78	125,-	346-080-600	130,-	962-645	22,-
50 kg	8,0	356-79	300,-	346-090-600	180,-	962-646	24,-

Class M2 · Weight sets, knob shape, finely turned brass

Test weight material: finely turned brass*

Weight	Knob shape, in aluminium protected case		Knob shape, in wooden case		DAkkS certificate	
	KERN 	€	KERN 	€	KERN	€
1 g - 50 g	354-426	117,-	354-42	93,-	962-615	42,-
1 g - 100 g	354-436	128,-	354-43	113,-	962-616	49,-
1 g - 200 g	354-446	162,-	354-44	153,-	962-617	61,-
1 g - 500 g	354-456	194,-	354-45	198,-	962-618	68,-
1 g - 1 kg	354-466	275,-	354-46	315,-	962-619	74,-
1 g - 2 kg	354-476	480,-	354-47	495,-	962-620	89,-
1 g - 5 kg	354-486	710,-	354-48	730,-	962-621	96,-
1 g - 10 kg	354-496	1140,-	354-49	1150,-	962-622	104,-

 *Material brass – only while stocks last! (Alternatively: stainless steel)

Test weights classes M3

Class M3 · Individual weights, knob shape, finely turned brass

Test weight material: finely turned brass*

! *Material brass – only while stocks last! (Alternatively: stainless steel)

Weight	Tol +/- mg	Individual weight, knob shape		Plastic box, lined		Aluminium protected box		Wooden box		DAkkS certificate	
		KERN	€	KERN	€	KERN	€	KERN	€	KERN	€
1 g	10	367-41	3,30	347-030-400	2,-	317-010-600	14,-	337-010-200	17,-	962-631	15,-
2 g	12	367-42	3,40	347-030-400	2,-	317-020-600	14,-	337-020-200	17,-	962-632	15,-
5 g	16	367-43	3,90	347-030-400	2,-	317-030-600	14,-	337-030-200	18,-	962-633	15,-
10 g	20	367-44	4,10	347-050-400	2,-	317-040-600	14,-	337-040-200	18,-	962-634	15,-
20 g	25	367-45	7,10	347-050-400	2,-	317-050-600	14,-	337-050-200	18,-	962-635	15,-
50 g	30	367-46	8,50	347-070-400	2,-	317-060-600	14,-	337-060-200	18,-	962-636	15,-
100 g	50	367-47	11,-	347-070-400	2,-	317-070-600	14,-	337-070-200	20,-	962-637	16,-
200 g	100	367-48	16,-	347-080-400	2,-	317-080-600	14,-	337-080-200	20,-	962-638	16,-
500 g	250	367-49	31,-	347-090-400	3,-	317-090-600	15,-	337-090-200	22,-	962-639	16,-
1 kg	500	367-51	46,-	347-110-400	3,-	317-110-600	22,-	337-110-200	36,-	962-641	16,-
2 kg	1000	367-52	84,-	347-120-400	4,-	317-120-600	26,-	337-120-200	36,-	962-642	17,-

Class M3 · Individual weights, knob and cylindrical shape, lacquered cast iron

Test weight material: cast iron

Weight	Tol +/- g	Individual weight, knob and cylindrical shape		DAkkS certificate	
		KERN	€	KERN	€
100 g*	0,05	366-91	17,-	962-637	16,-
200 g*	0,10	366-92	18,-	962-638	16,-
500 g**	0,25	366-93	25,-	962-639	16,-
1 kg**	0,50	366-94	30,-	962-641	16,-
2 kg**	1,0	366-95	55,-	962-642	17,-
5 kg**	2,5	366-96	99,-	962-643	17,-
10 kg**	5,0	366-97	170,-	962-644	17,-



Class M3 · Block weights, lacquered cast iron

Block weight material: cast iron, surface and edges refined

Weight	Tol +/- g	Block weight, cast iron		Aluminium protected box		DAkkS certificate	
		KERN	€	KERN	€	KERN	€
5 kg	2,5	366-86	54,-	346-060-600	80,-	962-643	17,-
10 kg	5,0	366-87	90,-	346-070-600	100,-	962-644	17,-
20 kg	10	366-88	158,-	346-080-600	130,-	962-645	22,-
50 kg	25	366-89	395,-	346-090-600	180,-	962-646	24,-

Class M3 · ECO Block weights, lacquered cast iron

ECO Block weight material: lacquered cast iron, surface and edges refined

Weight	Tol +/- g	ECO block weight, cast iron		Aluminium protected box		DAkkS certificate	
		KERN	€	KERN	€	KERN	€
5 kg	2,5	366-76	45,-	346-060-600	80,-	962-643	17,-
10 kg	5,0	366-77	72,-	346-070-600	100,-	962-644	17,-
20 kg	10	366-78	125,-	346-080-600	130,-	962-645	22,-
50 kg	25	366-79	300,-	346-090-600	180,-	962-646	24,-

Class M3 · Weight sets, knob and cylindrical shape, brass and lacquered cast iron

Test weight material: ≤ 50 g brass*, ≥ 100 g cast iron

Weight	Knob and cylindrical shape, in wooden block		DAkkS certificate	
	KERN	€	KERN	€
1 g – 1 kg	362-96	220,-	962-619	74,-
1 g – 2 kg	362-97	360,-	962-620	89,-
1 g – 5 kg	362-98	450,-	962-621	96,-
1 g – 10 kg	362-99	620,-	962-622	104,-



! *Material brass – only while stocks last! (Alternatively: stainless steel)

Tweezers, weight grips, gloves, dusting brush



Tweezers					
to be able to safely grip small test weights					
For class	For weight	Length	Version	KERN	€
E1 - M3	1 mg - 200 g	105 mm	1 Stainless steel with silicone-coated tips	315-243	14,-
E1 - M3	500 g - 2 kg	250 mm	1 Stainless steel with silicone-coated tips	315-245	46,-
E1 - M3	≤ 5 g	130 mm	2 Stainless steel, curved, high-quality plastic tips	315-246	22,-
E1 - M3	≤ 5 g	136 mm	3 Stainless steel, straight, high quality plastic tips	315-247	22,-
E1 - M3	≤ 200 g	225 mm	4 Stainless steel, straight, high-quality plastic tips, with a special shape for gripping weights of various shapes and sizes	315-248	38,-
F2 - M3	1 mg - 200 g	100 mm	5 Stainless steel	335-240	9,00
E1 - M3	1 mg - 200 g	100 mm	6 Plastic	315-242	6,20

Weight grip			
plastic coated			
For class	for knob shaped weights	KERN	€
E1 - M3	2 kg	315-273	28,-
E1 - M3	5 kg	315-274	32,-
E1 - M3	10 kg	315-275	36,-
E1 - M3	20 kg	315-276	53,-



1 not appropriate for cast iron weights



Gloves	
cotton, 1 pair. Help to protect the test weights when being used daily, from grease from fingers, damp etc.	
KERN	€
317-280	2,50



Gloves	
leather/cotton, 1 pair. Help to protect the test weights when being used daily, from grease from fingers, damp etc.	
KERN	€
317-290	6,90



Premium gloves	
Nylon, 1 pair. Particularly elastic, one size fits all, with special fingertip coating to ensure a safe grip. Helps to protect the test weights in everyday use from grease from fingers, damp etc.	
KERN	€
317-281	9,-



Dusting brush	
to clean the weights	
KERN	€
318-270	3,50



Bellows	
for cleaning weights	
KERN	€
318-271	7,-



Microfibre cloth	
for cleaning weights	
KERN	€
318-272	3,50

Boxes for individual weights



For weights ≤ 500 g, OIML class E1 - F1
For weights ≥ 1 kg, OIML class E1 - F1

Case material: Wood, lined, suitable for single weights, KERN-Nr. 307, 316, 317, 326, 327



For weights ≤ 500 g, OIML class F2 - M3
For weights ≥ 1 kg, OIML class F2 - M3

Case material: Wood, suitable for single weights, KERN-Nr. 337, 347, 357, 367
■ not suitable for cast iron weights



For test weights ≥ 10 kg, OIML class F1 - M1

Case material: Wood, suitable for single weights, KERN-Nr. 327, 337, 347
■ not suitable for cast iron weights

Wooden box, lined
for single weights E1 - F1

For weights	KERN	€
mg	338-090-200	19,-
1 g	317-010-100	26,-
2 g	317-020-100	26,-
5 g	317-030-100	26,-
10 g	317-040-100	26,-
20 g	317-050-100	26,-
50 g	317-060-100	27,-
100 g	317-070-100	29,-
200 g	317-080-100	29,-
500 g	317-090-100	30,-
1 kg	317-110-100	50,-
2 kg	317-120-100	58,-
5 kg	317-130-100	86,-
10 kg	317-140-100	97,-
20 kg	317-150-100	550,-
50 kg	317-160-100	670,-

Wooden box,
for single weights F2 - M3

For weights	KERN	€
mg	338-090-200	19,-
1 g	337-010-200	17,-
2 g	337-020-200	17,-
5 g	337-030-200	18,-
10 g	337-040-200	18,-
20 g	337-050-200	18,-
50 g	337-060-200	18,-
100 g	337-070-200	20,-
200 g	337-080-200	20,-
500 g	337-090-200	22,-
1 kg	337-110-200	36,-
2 kg	337-120-200	36,-
5 kg	337-130-200	60,-
10 kg	337-140-200	63,-
20 kg	337-150-200	360,-
50 kg	337-160-200	560,-

Wooden box
for test weights F1 - M1

For weights	KERN	€
10 kg	337-141-200	335,-
20 kg	337-151-200	360,-
50 kg	337-161-200	560,-



For weights ≤ 5 kg, OIML class E1 - M3

Case material: Aluminium protected, lined, suitable for single weights, KERN-Nr. 307, 316, 317, 326, 327, 337, 347, 357, 367
■ not suitable for cast iron weights

Aluminium protected box, lined
for individual weights, knob and compact shape, class E1 - M3

For weights	KERN	€
Individual weight, mg	317-009-600	15,-
1 g	317-010-600	14,-
2 g	317-020-600	14,-
5 g	317-030-600	14,-
10 g	317-040-600	14,-
20 g	317-050-600	14,-
50 g	317-060-600	14,-
100 g	317-070-600	14,-
200 g	317-080-600	14,-
500 g	317-090-600	15,-
1 kg	317-110-600	22,-
2 kg	317-120-600	26,-
5 kg	317-130-600	44,-



For weights ≤ 10 kg, OIML class E1 - M3

Case material: Aluminium protected, lined, suitable for single weights, KERN-Nr. 307, 316, 317, 326, 327, 337, 347, 357, 367
■ not suitable for cast iron weights

Aluminium protected box, lined
for individual weights, knob and compact shape, class E1 - M3

For weights	KERN	€
10 kg	317-140-600	62,-
20 kg	317-150-600	110,-
50 kg	317-160-600	250,-



For block weight ≥ 5 kg, OIML class F1 - M3

Case material: Aluminium protected, lined, suitable for block weights, KERN-Nr. 326, 336, 346, 356, 366

Aluminium protected case, lined
for individual weights F1 - M3

For weights	KERN	€
5 kg	346-060-600	80,-
10 kg	346-070-600	100,-
20 kg	346-080-600	130,-

Carrying cases/boxes for individual weight sets

Individual weight sets:

You can create your own "tailor-made" individual weight sets yourself. KERN will customise your own personal wooden box/plastic carrying case. The largest individual weight which will fit is given in the table.

Sample order:

Your individual weight set:
1 × 50 g, 2 × 100 g, 1 × 500 g, 2 × 1 kg, 1 × 2 kg.

The correct individual box is **KERN-Nr. 313-080-400** (plastic) or **KERN-Nr. 315-070-100** (wood)



Plastic case
for individual weight sets classes E1 - M3, not appropriate for cast iron weights

Largest possible weight	KERN		€
≤ 500 g	313-050-400		127,-
≤ 5 kg	313-080-400		245,-

Wooden case
lined, for individual weight sets classes E1 - F1
* with side handles

Largest possible weight	KERN		€
≤ 200 g	315-040-100		200,-
≤ 1 kg	315-060-100		295,-
≤ 2 kg	315-070-100		350,-
≤ 5 kg*	315-080-100		460,-
≤ 10 kg*	315-090-100		480,-

Wooden case not lined, for individual weight set classes F2 - M3, not appropriate for cast iron weights
* with side handles

Largest possible weight	KERN		€
≤ 200 g	335-040-200		110,-
≤ 500 g	335-050-200		110,-
≤ 1 kg	335-060-200		175,-
≤ 2 kg	335-070-200		186,-
≤ 5 kg*	335-080-200		280,-
≤ 10 kg*	335-090-200		300,-

Carrying cases for standard weight sets



Fig. shows 313-010-600

Aluminium protected case for safe storage and transportation under harsh industrial conditions.

Plastic case for weight sets
with standard denomination classes E1 - M3, not appropriate for cast iron weights

Largest possible weight	KERN		€
≤ 500 g	313-052-400		73,-
≤ 5 kg	313-082-400		182,-

Aluminium protected case
for weight sets with standard denomination classes E1 - M2
*1 front handle; **2 side handles; ***no handle

For weights	For class	KERN		€
1 mg - 500 mg	E1 - M1	313-010-600***		75,-
1 mg - 50 g	E1 - M1	313-020-600*		99,-
1 mg - 100 g	E1 - M1	313-030-600*		108,-
1 mg - 200 g	E1 - M1	313-040-600*		115,-
1 mg - 500 g	E1 - M1	313-050-600*		139,-
1 mg - 1 kg	E1 - M1	313-060-600*		169,-
1 mg - 2 kg	E1 - M1	313-070-600*		199,-
1 mg - 5 kg	E1 - M1	313-080-600**		265,-
1 mg - 10 kg	E1 - M1	313-090-600**		340,-
1 g - 50 g	E1 - M2	314-020-600***		94,-
1 g - 100 g	E1 - M2	314-030-600***		103,-
1 g - 200 g	E1 - M2	314-040-600***		110,-
1 g - 500 g	E1 - M2	314-050-600***		134,-
1 g - 1 kg	E1 - M2	314-060-600***		164,-
1 g - 2 kg	E1 - M2	314-070-600***		194,-
1 g - 5 kg	E1 - M2	314-080-600**		260,-
1 g - 10 kg	E1 - M2	314-090-600**		335,-

Weight carriers for block weights or other test weights

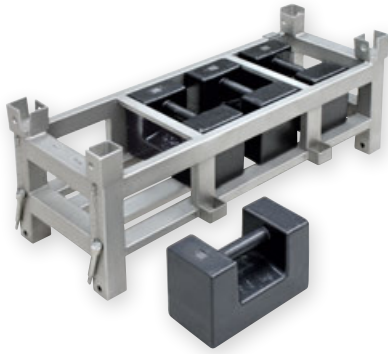

Individual weight carriers for testing high capacity floor scales, pallet scales, pallet truck scales, crane scales, etc. This can also be used for storing the weights. This means the weight container and the weights can be placed on the scale in one go, saving time and money.

The weight container can be calibrated to OIML accuracy classes M1 – M3. On request, KERN will make you a “tailor-made” weight carrier to your specifications.

Example:

9 block weights	each 50 kg, class M1 =	450 kg
1 weight container	each 50 kg, class M1 =	50 kg
Total		= 500 kg

Weight containers for rectangular weights or other test weights, adjusted to OIML class M1

Preconfigured weight containers for testing high-load floor scales, pallet scales, pallet truck scales, crane scales, etc. This can also be used for storing the weights. This means the weight container and the weights can be placed on the balance in one go, saving you time and money. The weight container is adjusted to OIML accuracy class M1. Other OIML accuracy classes are also available, please ask.

Weight of the weight container, OIML class M1	Tol +/- g	Possible equipment, rectangular weights, OIML class M1	Maximum total weight (weight container incl. weights)	Price (weight container excluding weights)
				KERN €
20 kg	1,0	5 × 20 kg	120 kg	346-022-005 1560,-
40 kg	1,5	8 × 20 kg	200 kg	346-042-008 2020,-
50 kg	2,5	10 × 20 kg	250 kg	346-052-010 2020,-
50 kg	2,5	4 × 50 kg	250 kg	346-055-004 2020,-
50 kg	2,5	9 × 50 kg	500 kg	346-055-009 2020,-
60 kg	3,0	8 × 50 kg and 2 × 20 kg	500 kg	346-065-009 2190,-

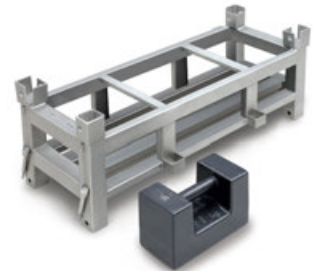

Weight of the weight container, OIML class M1	Tol +/- g	Possible equipment, test weights, OIML class M1	Maximum total weight (weight container incl. weights)	Price (weight container excluding weights)
				KERN €
20 kg	1,0	max. 10 × 10 kg or 5 × 20 kg	120 kg	347-022-005 1560,-
40 kg	2,0	max. 16 × 10 kg or 8 × 20 kg	200 kg	347-042-008 1840,-
50 kg	2,5	max. 20 × 10 kg or 10 × 20 kg	250 kg	347-052-010 2020,-
60 kg	3,0	max. 22 × 20 kg	500 kg	347-062-022 2190,-



Individual weight containers for rectangular weights or other test weights, calibrated to OIML class M1

Weight of the weight container, OIML class M1		
	KERN	€
Individual weight container for rectangular weights	346-000-000	Price on request
Individual weight container for test weights	347-000-000	Price on request

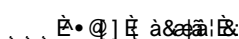

The DAkkS (German accreditation body)

The DAkkS is the national accreditation body of the Federal Republic of Germany. According to Regulation (EC) No. 765/2008 and the Accreditation Body Act (AkkStelleG), the DAkkS acts in the public interest as the sole service provider for accreditation in Germany.

In order to be able to fulfil its sovereign accreditation tasks, the DAkkS was entrusted by the Federal Government. As an entrusted body, the DAkkS is subject to federal supervision.

Only an accredited calibration laboratory can issue a DAkkS calibration certificate. This defines not only the measuring method as well as the measuring result, but also gives information on tracing the test medium to national standards and the relevant uncertainty of measurement.

- **You are certified to ...**
ISO 9001, QS 9000, GLP, GMP, TS16949
- **You need ...**
to control your measuring equipment
- **Our solution ...**
DAkkS calibration certificate; (traceability, measuring uncertainty, internationally recognised)

KERN – Precision is our business

The KERN calibration laboratory for electronic balances and weights has been accredited by DKD since 1994 and today is one of the most modern and best-equipped DKD calibration laboratories for balances, test weights and force measurement in Europe.

Thanks to the high level of automation, we can carry out DAkkS calibration of balances, test weights and force-measuring devices 24 hours a day, 7 days a week.

Do you have any further requests or questions on this matter? We would be pleased to help you or visit us on the web at www.kern-lab.com

DAkkS calibration

Why? DAkkS calibration is always necessary when checking equipment (balance or test weight) is to be used in a QM process (e.g. to ISO 9000ff, GS 9000, TS 16949, VDA 6.1, FDA, GLP, GMP, GMP etc.)

What? Any checking equipment in proper condition can be DAkkS calibrated

How? Determination of accuracy throughout the world by a laboratory which is accredited to DIN EN ISO 17025. Traceability to internationally recognised standards. The DAkkS calibration certificate confirms both the measurement characteristics of the checking equipment and the general requirements for the control of checking equipment.

Where? Internationally recognised – this is monitored by ILAC (International Laboratory Accreditation Cooperation) and e.g. DAkkS (German calibration service) in Germany

When? The operator control the use of checking equipment and periodic recalibration time intervals themselves

Range of services:

- DAkkS calibration of balances with a maximum load of up to 50.000 kg
- DAkkS calibration of weights in the range of 1 mg – 2.500 kg. Calibrations can be carried out in the following classes: E1, E2, F1, F2, M1, M2, M3
- DAkkS calibration of force gauges and force transducers
- Volume determination for weights of accuracy class E1
- Measuring of sensitivity (magnetic characteristics)
- Factory calibration in various sizes:
- Force (sensors and measuring devices), hardness (Shore, UCI, Leeb, etc.), thickness of coatings and walls, torque wrench testing devices, and much more
- Conformity assessments and recalibration of balances and weights at the KERN verification point, working closely with the verification authorities

And on top of all these services, we also offer additional services – see page 212/213.

Balance & weight in the quality management system

Do you already use all the modules of the KERN precision package for maximum accuracy and reliability of your balance?

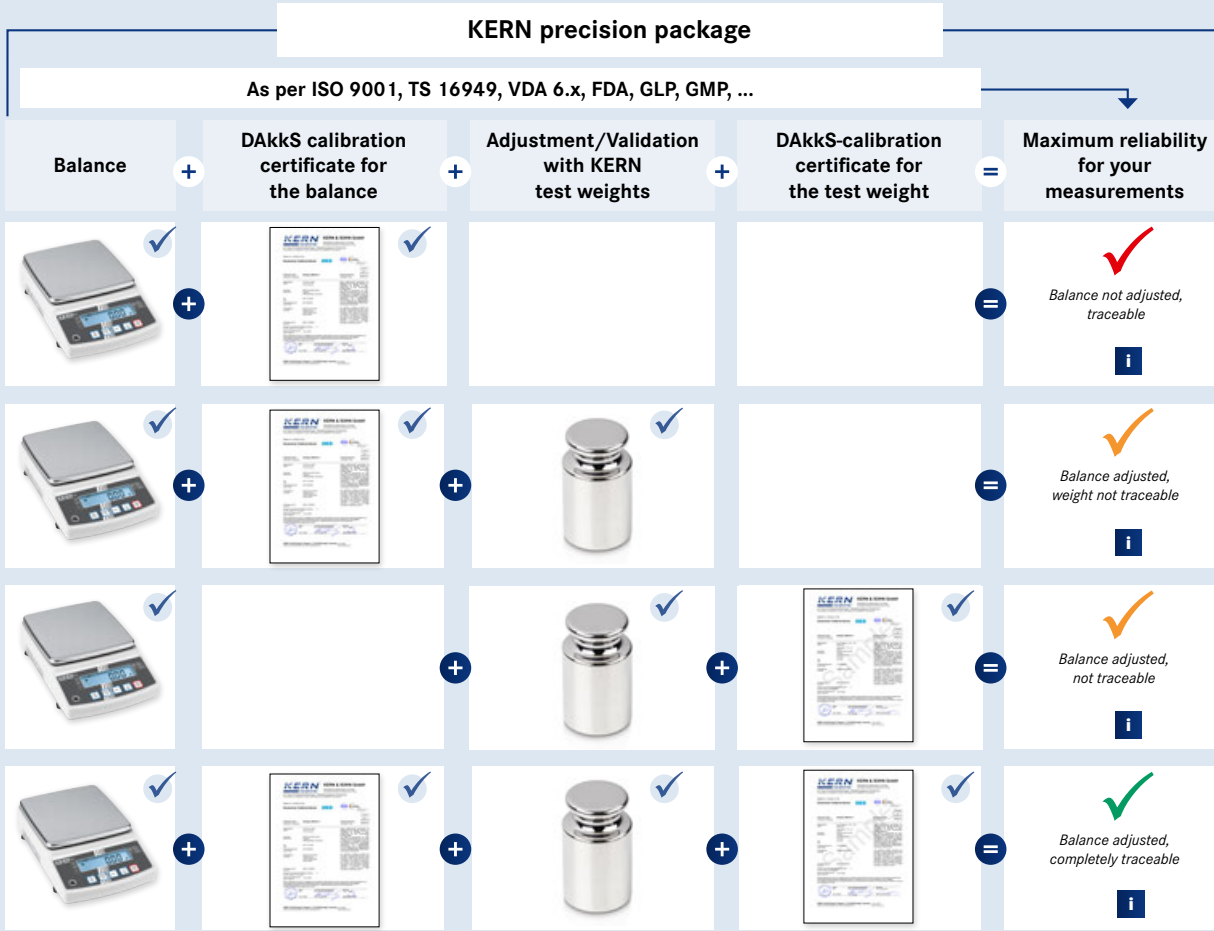

Information & ordering:
kern-sohn.com/qmb

The KERN calibration laboratory (D-K-19408-01-00)

KERN has a highly-automated DAkkS laboratory with accreditation to DIN EN ISO/IEC 17025 in the field of balances, test weights and force measurement. By using the most modern calibration technology with high-end calibration robots in fully air-conditioned laboratories, the measurement uncertainty and process times are reduced to a minimum, and also the quality of the calibration is increased.

As an accredited and certified calibration service provider with decades of experience, KERN offers you an extensive range of services, which will leave no demand unfulfilled. The accreditation applies to the extent specified in the appendix to the certificate D-K-19408-01-00.

We offer the following services:

- Waagen:**
- ▶ DAkkS calibration up to 50 t
 - ▶ Minimum sample weight (in use)
 - ▶ Usage accuracy
 - ▶ Adjustment at the location of installation
 - ▶ Certificate of conformity
 - ▶ Equipment qualification:
 - > Installation qualification (IQ)
 - > Function qualification (OQ)
 - > Performance qualification (PQ)
 - > Maintenance qualification (MQ)
 - ▶ Verification

- Weights:**
- ▶ DAkkS calibration up to 2.5 t (OIML classes E1 – M3)
 - ▶ Volume determination for OIML class E1
 - ▶ Measuring of sensitivity (magnetic characteristics)
 - ▶ Verification

- Force measuring devices and force transducers:**
- ▶ DAkkS calibration up to 5 kN

- Factory calibration for:**
- ▶ Force measuring devices and force transducers ≤ 250 kN
 - ▶ Hardness
 - ▶ Layer thickness
 - ▶ Material thickness
 - ▶ Temperature of moisture analysers

Our commitment to satisfy our customers never stops. Perhaps this is one of the reasons why our roots can perhaps be traced so far back in history. **Discover the KERN route to success: fast - competent - reliable - versatile!**

The order process

- 1 You will receive a **reminder** that your test equipment is due or you will generate a quotation for new or existing test equipment
- 2 Submission or collection of your test equipment
- 3 Initial inspection of your goods, to check that they are suitable for calibration, and are complete, etc.
- 4 You will get a detailed order confirmation
- 5 Our experts will carry out initial calibration
- 6 Checked for conformity with required tolerances and if required, any necessary actions which arise from this are carried out
- 7 Before these actions are carried out, we will contact you (in so far as no individual processing has been agreed with you beforehand)
- 8 After your approval the necessary actions will be implemented and the calibration will be completed
- 9 After that your test equipment will be returned without delay, together with the appropriate calibration certificates
- 10 We will monitor your recalibration periods and will send you, free of charge, a reminder about your next calibration

Our service

► Reminder service

The continuous cyclic recalibration of your checking equipment is an integral part of the reliable management of test equipment. You can depend on us to support you, and we will remind you in good time, free of charge, when the next recalibration is due. In addition, you have the option of managing your test equipment yourself online (cf. 1, 10).

► Quote generator

You will be impressed by our price-to-performance ratio. Request a non-binding quotation or create it yourself to suit your specifications at www.kern-lab.com (cf. 1).

► Collection service

We will be pleased to arrange for our shipping company to pick up the goods from your premises. Simply tell us the weight and dimensions of your package and leave the rest to us (cf. 2).

► Repair and reconditioning of balances and weights

KERN will get your weights back up to standard, regardless of the manufacturer. Whether it is adjustment, marking, sand blasting or lacquering - the aim here is compliance and long-term stability. Any repairs of balances and instruments which may be necessary can be carried out quickly and easily (cf. 5, 6).

► Individual processing

In order to avoid delays with future orders, we would be pleased to incorporate your individual requirements for future processing of such calibration results. Even for smaller issues such as the printing of calibration certificates (stapling, punching, double-sided) we can work to your requirements (cf. 8).

► Express service and dispatch

If you need a particularly fast service, you can use your DAkkS express service. You will receive your test equipment after just 2 days (cf. 9).

www.kern-lab.com – the central portal for everything you need to know about the extensive KERN calibration services

On our website you will always find the latest news and useful information about testing and measuring devices, calibration, legal metrology and expansions to our range of services. You will also find numerous online services on the website.

Database supported management of test equipment

Information on your test equipment which has been calibrated by us is stored in our database. In this way it is possible to make trend calculations. You will therefore get an overview of the long-term stability and trend behaviour of your test equipment and the necessary recalibration period can easily be determined and specified.

Paperless documentation

So that there is no administrative effort, we can handle all calibration documentation in a paperless process. From quotation, through to order confirmation, delivery note and invoice right up to calibration certificate, you will receive all documents by e-mail or you can retrieve them online. Would you prefer to receive your certificate or your invoice, for example, in paper form? Of course this is not a problem either. We will send you everything you require by post.

Calibration certificate download

Using our download service you can easily download your calibration certificates as soon as the calibration work is complete and you will have access to them at any time in the future. Simply create your user account on www.kern-lab.com and you will never need to look for your certificates again.

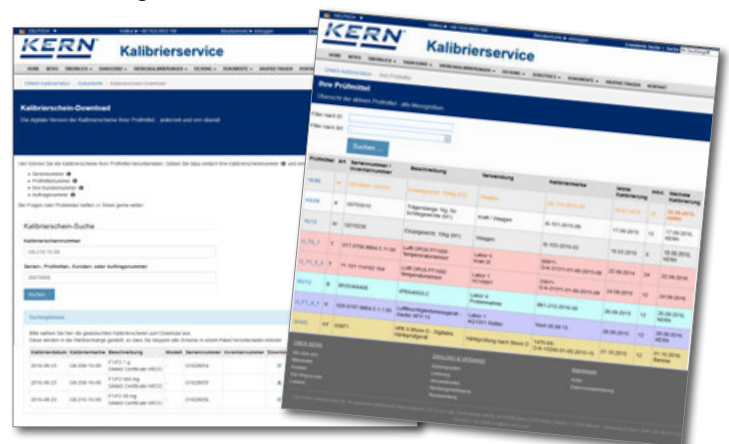

DAkkS Calibration of balances

Any balance will only give correct results if it is checked regularly, i.e. calibrated correctly and adjusted when required. A balance is only a reliable measuring and checking tool if it is calibrated and this calibration is documented. The issued DAkkS calibration certificates are proof of the metrological traceability to national and international standards, as required by the DIN EN ISO 9000 and DIN EN ISO/IEC 17025 standards, amongst others. KERN recommends a recalibration period of one year. The standard does not give a defined recalibration period. KERN recommends that, with intensive (daily) use, you recalibrate your balance every 6 months and with normal (weekly) use, every 12 months.

THE ADVANTAGES OF USING THE KERN ON-SITE CALIBRATION:

- + **Calibration on-site** at your premises in the field of use
- + **No risk of damage** during transportation
- + **Low downtime**
- + **Cross-brand servicing**, basic inspection and adjustment by a specialist
- + You tell us **when you would like us to come**
- + **Device training** for qualified users



a) KERN on-site calibration (we visit you)

In Germany, KERN has a close-knit network of KERN DAkkS calibration laboratory employees, who can carry out on-site calibration of balances up to 50 tonnes.

This on-site testing service is metrologically recommended, as your balance is in its field of use and can be calibrated without any possible transportation problems.

Lower downtime and personal contact with our expert are the major benefits of this service.

Preparatory maintenance work by agreement. Prices for on-site calibration on request.

You tell us when you would like us to come, giving us details of the balances to be tested. Our on-site DAkkS calibration team will then get in touch with you immediately and will discuss the process with you at your premises – it's straight forward and professional.

This KERN calibration service is also independent of the brand.

Please feel free to contact us at Phone +49 7433 9933-400 or E-Mail: testservices-onsite@kern-sohn.com

THE ADVANTAGES OF USING THE KERN IN-HOUSE CALIBRATION:

- + **Short calibration time:** Test time in the laboratory is only four working days
- + **Competence:** Calibration laboratory, which complies with the highest standards in the area of metrology
- + **Independent management** of the recalibration calendar for your individual measuring instrument is possible
- + **Cross-brand service:** Measuring devices from any manufacturer can be calibrated independently
- + **Repair:** Any necessary repairs can be carried out immediately, if you wish

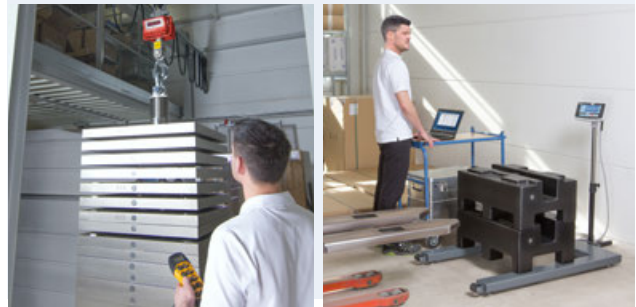

b) Calibration at the KERN factory (you send your balance to us)

Recommended for new devices and for balances which can be affordably transported, as then there is no need for us to travel to carry out the calibration on-site. Repairs can be carried out at the same time, quickly and in full.

The process would be as follows:

- Day 1: Send your balance to the KERN calibration laboratory in Balingen.
- Day 2 to 3: Evaluation and calibration of your balance by our specialists.
- Day 4: After positive validation, your balance is returned.

Please feel free to contact us at Phone +49 7433 9933-196 or E-Mail: testservices@kern-sohn.com

KERN & SOHN GmbH
 Akkreditiertes Kalibrierlabor seit 1994.
 Accredited calibration laboratory since 1994.

Deutscher Kalibrierdienst DKD

Sample-2020-01/1

Kalibrierschein / Calibration Certificate

Gegenstand / Objekt: Analytierv Waage / Analyt. Balance

Hersteller / Manufacturer: KERN & SOHN GmbH, Ziegels 1, 72336 Balingen-Frommann

Typ / Type: ABT 120-SDM

Fabrikat/Serien-Nr. / Serial number: WX12345678

Auftraggeber / Customer: Mustermann GmbH, Musterweg 42, 12345 Musterstadt, Deutschland

Messergebnisse / Measurement results

Zustand #1 / Ursprungszustand / as found state: Der Kennwert der Waage wurde vor der Kalibrierung mit dem internen Justiergewicht justiert.

Temperatur / Temperature: zu Beginn / at the beginning, 22,0 °C

1. Wiederholbarkeit / Repeatability

Messung / Measuring	Prüflast / Load	Waagenanzeige / Indication
No. 1	100 g	100.0002 g
No. 2	100 g	100.0003 g
No. 3	100 g	100.0004 g
No. 4	100 g	100.0004 g
No. 5	100 g	100.0004 g

2. Außermitte Belastung / Economy

Position	Prüflast / Load	Waagenanzeige / Indication
No. 1	50 g	50.0001 g
No. 2	50 g	50.0001 g
No. 3	50 g	50.0000 g
No. 4	50 g	50.0002 g
No. 5	50 g	50.0002 g

3. Richtigkeit / Errors of indication

Messunsicherheit / Measuring uncertainty

Zustand / State #1 - (Ursprungszustand / as found, - / - / -)

Prüflast / Load	Abweichung / Error	Erweiterungsfaktor k / Coverage factor	Unsicherheit / Uncertainty	relative Unsicherheit / Rel. uncertainty
20 g	0.0001 g	2.57	0.00026 g	0.00129 %
50 g	0.0002 g	2.18	0.00029 g	0.00054 %
70 g	0.0003 g	2.05	0.00035 g	0.00048 %
100 g	0.0004 g	2.06	0.00034 g	0.00033 %
120 g	0.0005 g	2.02	0.00041 g	0.00033 %

Verwendungsgenauigkeit / Total usage accuracy

Diagramm der Verwendungsgenauigkeit / Graph of usage accuracy

7

8

DAkKS calibration certificate for balances (extract)

- 1 Official document
- 2 Item to be calibrated
- 3 Traceability, see page 225

- 4 Identification/Applicant
- 5 Metrological component
- 6 Uncertainty of measurement, see page 225

- 7 Application accuracy, see page 223
- 8 Minimum weight of sample (additional price)

To get reliable weighing results you need to have calibrated balances. KERN offers you an extensive calibration service for your balances – you have the choice:

Recalibration

- The recalibration schedule depends on the frequency of use, the conditions of use and the safety requirements.
- We would recommend that you recalibrate your balances every 6 months if they are used intensively, and every 12 months with normal use.
- The KERN calibration service is independent of the brand.



Initial calibration and recalibration of balance at the KERN factory	KERN	Price excl. of VAT ex works €
Weighing capacity		
Analytical balances		
[Max] ≤ 5 kg	963-101	152,-
[Max] > 5 kg	963-102	194,-
Precision balances/Industrial scales		
[Max] ≤ 5 kg	963-127	78,-
[Max] > 5 kg – 50 kg	963-128	94,-
[Max] > 50 kg – 350 kg	963-129	116,-
[Max] > 350 kg – 1500 kg	963-130	165,-
[Max] > 1500 kg – 2900 kg ¹⁾	963-131	220,-
[Max] > 2900 kg – 6000 kg ¹⁾	963-132	440,-
[Max] > 6000 kg – 12000 kg ¹⁾	963-133	500,-
Hanging scales/Crane scales		
[Max] ≤ 5 kg	963-127H	78,-
[Max] > 5 kg – 50 kg	963-128H	94,-
[Max] > 50 kg – 350 kg	963-129H	110,-
[Max] > 350 kg – 1500 kg	963-130H	200,-
[Max] > 1500 kg – 2900 kg	963-131H	300,-
[Max] > 2900 kg – 6000 kg	963-132H	500,-
[Max] > 6000 kg – 12000 kg ³⁾	963-133H	700,-
Preparation for recalibration (cleaning, adjustment, function test)	969-003R	20,-
Additional services		
Minimum weight of sample (for details see p. 215)	969-103	10,-
Additional measurement points (as part of the) weighing test	963-140	5,-/ measurement point
Additional measurement points (as part of the) repeatability testing	963-140	5,-/ each further m.p.
DAkKS Express service with delivery time 48 hours (only on initial purchase, details see p. 218)	962-116	50,-/ scale
Express shipping: Express supplement for guaranteed delivery on the next working day (if ready for shipment before 12:00 noon)	in GER only	parcel

1) Floor scales & axle load scales only (Price per weighing panel). Please ask for further details.
 2) On request
 3) Processing time 4 working days
 4) Processing time 15 working days

Minimum weight of sample (in use)

What is the lightest item you can weigh on your balance, while still achieving accurate and reliable weighing results? What exactly is the limit?

The KERN minimum sample weight protocol accounts for the established minimum sample weight of your balance and its location of installation and use with the relative measuring uncertainty. With various safety coefficients and required weighing accuracy (process accuracy), depending on standard or quality-related requirements on the balance being used.

The higher the selected safety coefficient, the higher the safety when using the balance in a particular process. Typical perturbations when using the balance e.g. small fluctuations in temperature are taken into account. In easily predictable conditions in a professional environment of use, KERN recommends a safety coefficient of 3. For critical processes, a correspondingly higher factor should be selected. The minimum sample weight protocol contains a diagram as well as a table, from which you can ascertain the minimum sample weight for your balance, depending on the process.

Adjustment at the location of installation

Why?

Adjustment at the location of installation is necessary, as the measuring results of balances depend on the local gravitational force (gravitational acceleration) and therefore depend on the location of use. KERN can carry this out just before shipping at the factor, individually to suit the location of installation.

What are the advantages of carrying out adjustment at the location of installation?

- The balance gives reliable measurement results at the location of installation.
- No time-consuming on-site adjustment necessary.
- You do not need a Service Engineer or any additional weights.
- The balance is ready for immediate use.

Pricing table for adjustment at the location of installation

Weighing capacity	KERN	Price excl. of VAT ex works €
[Max] ≤ 5 kg	961-247	36,-
[Max] > 5 - 50 kg	961-248	44,-
[Max] > 50 - 350 kg	961-249	52,-
[Max] > 350 - 1500 kg	961-250	83,-
[Max] > 1500 - 2900 kg	961-251	110,-
[Max] > 2900 - 6000 kg	961-252	220,-
[Max] > 6000 - 12000 kg	961-253	250,-

For adjustment to the location of installation you need the value for gravitational acceleration at the location of installation, which KERN can calculate using the point of use. The procedure is suitable for balances with a resolution of <60,000 d. For higher resolutions we recommend a balance with an internal adjusting weight or adjustment with a calibrated adjusting weight at the location of installation.

Certificate of conformity

With a certificate of conformity you get a statement about whether the balance meets your defined requirements.

In conjunction with a DAkkS calibration certificate it serves as documented proof that the balance fulfils the required process demands. When doing this the process owner for the balance can select from different temperature specifications – depending on its individual requirements:

Conformity evaluation on the basis of the:	KERN		Price excl. of VAT ex works €
Usage accuracy*	relative	969-511	on request
	absolute	969-512	
Calibration results*	relative	969-513	on request
	absolute	969-514	
Measurements as manufacturer or customer specification	Foreign device	969-515	on request
	Customer specifications	969-516	
	KERN devices	969-517	

relative = % / absolute = g

*as attachment to the DAkkS calibration certificate (Details see www.kern-lab.com)

Example for absolute customer tolerance (absolute) (Item no. 969-511):

No.	Tare	Load	Display	Deviation	Uncertainty	Customer tolerance	Conformity ¹⁾
1	0 g	500 g	500,00 g	0,00 g	± 0,013 g	± 0,05 g	☑
2	0 g	1000 g	1000,00 g	0,00 g	± 0,015 g	± 0,05 g	☑
3	0 g	1500 g	1500,01 g	0,01 g	± 0,017 g	± 0,05 g	☑
4	0 g	2000 g	2000,01 g	0,01 g	± 0,020 g	± 0,10 g	☑
5	0 g	3000 g	3000,02 g	0,02 g	± 0,022 g	± 0,10 g	☑

1) Evaluation criteria: |[Deviation]| + [extended measuring uncertainty] ≤ [tolerance]

Documented quality of your balances in the log book

Consistently high product quality requires the use of measuring and test equipment that provides comprehensible, consistent and reproducible results. Hence, quality management systems require that measuring and test equipment produces a detailed traceable description and documentation of calibration results and conformity statements. Work not documented is work not done.

Equipment qualification is documentary evidence that a equipment is suitable for the intended purpose and is working faultlessly. A balance log book is used to record all activities and results required for the qualification and monitoring of balances during routine operation. This includes the installation and commissioning of the balances, routine tests, maintenance as well as the recording of special events (failures, repairs, change of location).

The structure of the balance log book is based on the qualification process of the balance. The requirements for the qualification system such as DIN EN ISO 9001, DIN EN ISO/IEC 17025, GLP/GMP, VDA must be taken into account. The log book supports the user in his/her daily work with the balance and is meant to serve as necessary evidence during inspections and audits. The responsibility for maintaining the log book and its appropriate use is to be borne by the user.

Our proposal: Count on our support!

KERN offers this qualification concept throughout. Our validation services are carried out on the spot by technicians of our calibration laboratory and comprise among other things: installation, measurement test inclusive DAkks calibration certificate as well as records in your qualification log book.

We give you advice about the options of device qualification, as required and will be happy to set up an appointment for qualification at the place of installation. We offer individual calibration and maintenance agreements for the periodically required requalification.

Further information can be found at www.kern-lab.com



Installation qualification (IQ)

All steps to be taken for the installation and commissioning of the equipment are described in detail in the installation qualification. These include among others:

- checking for completeness of delivery and assurance that the delivered equipment meets the required specifications
- a description of the ambient conditions at the place of installation
- proper installation and assurance that the equipment is ready for operation after installation
- documentation of equipment configuration and equipment settings
- Recording and installation of connected peripherals units



Function qualification (OQ)

The operational qualification describes the metrological test performed for the balance at the place of installation. In the course of this all parameters that define the efficiency of a measurement will be checked. Functional qualification is carried out with the help of a standard operating procedure (SOP) and recorded in a calibration certificate. The OQ must be carried out by trained staff with the help of qualified aids (such as certified weights that are traceable to an approved standard). Briefing / training of users must be assured and recorded in the OQ.



Performance qualification (PQ)

The PQ represents documented evidence that the balance or weighing system functions in the selected application as intended. This will be assured by a qualification test of the equipment under real conditions with respect to its surroundings and the problem definition (such as traceable data transmission). If the balance or weighing system is "merely" to be used for weighing it will not be necessary to carry out a PQ as the ability to function has already been proven during the metrological test (OQ).



Maintenance qualification (MQ)

The periodical maintenance, cleaning work and complete metrological test of the balance/weighing system is documented in the MQ by a trained authorised engineer. The results are documented on a DAkks calibration certificate. Maintenance is carried out with the help of a maintenance schedule.



If you are interested in a qualification or training for equipment qualification, please feel free to contact us at **+49 7433 9933-400**

KERN & SOHN GmbH
 Akkreditiertes Kalibrierlabor seit 1994.
 Accredited calibration laboratory since 1994.

Ihr Partner für Kalibrierdienstleistungen, Prüfmittelmanagement und Beratung.
 Your partner for calibration services, test equipment management and support.

Mitglied im / member of the
Deutschen Kalibrierdienst DKD **DAkKS**

Sample
 D.K. 19408-01-00
 2020-01

Kalibrierschein Sample-2020-01/1 **1**
 Calibration certificate

Kalibrierzeichen
 Calibration mark

Gegenstand Gewichtssatz, 1 mg - 1 kg **2**
 Objekt Klasse E2
 Set of weights, 1 mg - 1 kg
 Class E2

Hersteller KERN & Sohn GmbH
 Ziegelei 1
 D-72336 Balingen
 Germany **3**

Typ 313-052 **3**

Fabrikate/Serien-Nr. G123456789
 Serial number

Auftraggeber Mustermann GmbH **4**
 Customer

Auftragsnummer 2020-123456789
 Order No.

Die Seiten des Kalibrierscheins entsprechen den Bezugsnormen
 The pages of the calibration certificate correspond to the reference standards.

Ort der Kalibrierung: Kalibrierlaboratorium KERN
 Place of calibration Calibration - Laboratory KERN

Umgebungsbedingungen: Die Kalibrierung wurde bei folgenden Umgebungsbedingungen ausgeführt.
 Ambient conditions The calibration was carried out under the following ambient conditions:

	von from	bis to	Unsicherheit uncertainty
Temperatur (°C) temperature	22,9	24,1	0,1
rel. Luftfeuchte (%) relative humidity	48,5	53,4	2,0
Luftdruck (hPa) air pressure	942,5	948,5	0,3

Magnetische Eigenschaften: Der Hersteller hat bestätigt, dass die Gewichtsstücke die magnetischen Eigenschaften gemäß R111:2004 enthalten.
 Magnetic properties The manufacturer has confirmed the compliance of the magnetic properties of the weight pieces with the OIML R111:2004.

Referenzgewichte: 123-D-K-19408-01-00-2019-05
 Standard weights

Material / angenommene Dichte:
 Material / assumed density

Nennwert nominal value	Dichte density	Unsicherheit uncertainty	Material material	Form shape
1 mg - 500 mg	7950 kg/m³	140 kg/m³	Edelstahl Stainless steel	Draht Wire
1 g - 1 kg	8000 kg/m³	100 kg/m³	Edelstahl Stainless steel	Knopf Cylindrical form

Messergebnisse: Measurement results

Nennwert nominal value	Kennzeichnung marking	konventioneller Wägwert conventional mass	Unsicherheit k=2 uncertainty	Fehlergrenze max. perm. error	Klasse* class*
1 mg		1 mg + 0,0010 mg	0,0020 mg	± 0,0060 mg	E2 ✓
2 mg		2 mg + 0,0005 mg	0,0020 mg	± 0,0060 mg	E2 ✓
2 mg	*	2 mg + 0,0016 mg	0,0020 mg	± 0,0060 mg	E2 ✓
5 mg		5 mg + 0,0010 mg	0,0020 mg	± 0,0060 mg	E2 ✓
10 mg		10 mg + 0,0009 mg	0,0020 mg	± 0,0060 mg	E2 ✓
20 mg		20 mg - 0,001 mg	0,003 mg	± 0,010 mg	E2 ✓
20 mg	*	20 mg + 0,001 mg	0,003 mg	± 0,010 mg	E2 ✓
50 mg		50 mg + 0,001 mg	0,004 mg	± 0,012 mg	E2 ✓
100 mg		100 mg + 0,001 mg	0,005 mg	± 0,016 mg	E2 ✓
200 mg		200 mg + 0,002 mg	0,006 mg	± 0,020 mg	E2 ✓
200 mg	*	200 mg + 0,003 mg	0,006 mg	± 0,020 mg	E2 ✓
500 mg		500 mg + 0,005 mg	0,008 mg	± 0,025 mg	E2 ✓
1 g		1 g + 0,002 mg	0,010 mg	± 0,030 mg	E2 ✓
2 g		2 g + 0,002 mg	0,013 mg	± 0,040 mg	E2 ✓
2 g	*	2 g + 0,002 mg	0,013 mg	± 0,040 mg	E2 ✓
5 g		5 g + 0,010 mg	0,016 mg	± 0,050 mg	E2 ✓
10 g		10 g - 0,007 mg	0,020 mg	± 0,060 mg	E2 ✓
20 g		20 g + 0,005 mg	0,026 mg	± 0,080 mg	E2 ✓
20 g	*	20 g + 0,015 mg	0,026 mg	± 0,080 mg	E2 ✓
50 g		50 g + 0,02 mg	0,03 mg	± 0,10 mg	E2 ✓
100 g		100 g + 0,01 mg	0,05 mg	± 0,16 mg	E2 ✓
200 g		200 g + 0,05 mg	0,10 mg	± 0,30 mg	E2 ✓
200 g	*	200 g - 0,00 mg	0,10 mg	± 0,30 mg	E2 ✓
500 g		500 g + 0,10 mg	0,26 mg	± 0,80 mg	E2 ✓
1 kg		1 kg + 0,1 mg	0,5 mg	± 1,6 mg	E2 ✓

* Bewertung der Klasse bzw. der Fehlergrenze (wenn keine Klassenangabe vorhanden ist) bezieht sich nur auf den konventionellen Wägwert.
 * The assessment of the class / the max. perm. error (if no class assessment is given) only refers to the conventional mass.

Angaben ist die erweiterte Messunsicherheit, die sich aus der Standardunsicherheit durch Multiplikation mit dem Erweiterungsfaktor k=2 ergibt. Sie wurde gemäß EA-402 M: 2013 ermittelt. Der Wert der Messgröße liegt mit einer Wahrscheinlichkeit von 95% im angegebenen Wertintervall.
 The extended measurement uncertainty was determined by multiplying the standard uncertainty with the expansion factor k=2. It was determined according to EA-402 M: 2013. The value of the measurand lies with a probability of 95% in the given value interval.

Traceable KERN test weights –

Calibration of test weights

Calibrated measuring equipment requires calibrated checking equipment. For balances, these are calibrated test weights, also called “standard weights”.

KERN will calibrate your test weights

- In all classes with permissible error limits E1–M3 according to OIML R111:2004 (for tolerance tables, see page 188), in sizes 1 mg to 2500 kg.
- With free nominal value
- Newton (N)
- Independent of design (special designs)

The advantages of using the KERN in-house calibration

You send your test weights to us.

- Excellent price performance ratio
- The quickest processing time
 - DAkKS standard service: 4 working days
 - DAkKS express service: 48 hrs (new weights)
- The most modern calibration methods with robot controlled comparators allow the most accurate calibration results and fastest throughput time
- KERN DAkKS calibration certificates are internationally recognised
- A calibration service which is independent of the brand
- KERN also reconditions existing customer weights (e.g. cleaning or readjustment)
- On request, we can also provide a pick-up and collection service with our parcel service

The advantages of using the KERN on-site calibration

We visit you.

We would be pleased to visit you within Germany and carry out the calibration of your reference standards to OIML classes M1–M3, 10 kg–2500 kg with permissible error limits, using our mobile MACOS system. Minimized downtime of your checking equipment and direct contact with our expert are the major benefits of this service. Price on request.

Recalibration

- The recalibration schedule depends on the frequency of use, the conditions of use and the safety requirements
- In terms of standardisation, no particular recalibration interval is specified
- We would recommend that you recalibrate your test weights every six months if they are used intensively, and every 12 months with normal use
- We would be pleased to monitor your recalibration schedule

DAkKS calibration certificate for test weights (extract).

For more details on our calibration service and other useful information, please see the internet on www.kern-lab.com

- 1 Official document
- 2 Item to be calibrated
- 3 Traceability, see page 225
- 4 Identification/Applicant
- 5 Environmental conditions
- 6 Metrological component
- 7 Conventional mass
- 8 Uncertainty of measurement, see page 225

Recalibration price of test weights (DAkkS calibration)

Class acc. →	E1 with volume determination		E1 without volume determination		E2		F1/F2 * F2 only		M1/M2/M3	
	Nominal value ↓	Price € excl. of VAT ex works	KERN	Price € excl. of VAT ex works	KERN	Price € excl. of VAT ex works	KERN	Price € excl. of VAT ex works	KERN	Price € excl. of VAT ex works
1 mg	-	-	962-251R	57,-	962-351R	27,-	962-451R	18,-	962-651R	15,-
2 mg	-	-	962-252R	57,-	962-352R	27,-	962-452R	18,-	962-652R	15,-
5 mg	-	-	962-253R	57,-	962-353R	27,-	962-453R	18,-	962-653R	15,-
10 mg	-	-	962-254R	57,-	962-354R	27,-	962-454R	18,-	962-654R	15,-
20 mg	-	-	962-255R	57,-	962-355R	27,-	962-455R	18,-	962-655R	15,-
50 mg	-	-	962-256R	57,-	962-356R	27,-	962-456R	18,-	962-656R	15,-
100 mg	-	-	962-257R	57,-	962-357R	27,-	962-457R	18,-	962-657R	15,-
200 mg	-	-	962-258R	57,-	962-358R	27,-	962-458R	18,-	962-658R	15,-
500 mg	-	-	962-259R	57,-	962-359R	27,-	962-459R	18,-	962-659R	15,-
1 g	963-231	210,-	962-231R	57,-	962-331R	27,-	962-431R	18,-	962-631R	15,-
2 g	963-232	210,-	962-232R	57,-	962-332R	27,-	962-432R	18,-	962-632R	15,-
5 g	963-233	210,-	962-233R	57,-	962-333R	27,-	962-433R	18,-	962-633R	15,-
10 g	963-234	210,-	962-234R	57,-	962-334R	27,-	962-434R	18,-	962-634R	15,-
20 g	963-235	210,-	962-235R	57,-	962-335R	27,-	962-435R	18,-	962-635R	15,-
50 g	963-236	210,-	962-236R	57,-	962-336R	27,-	962-436R	18,-	962-636R	15,-
100 g	963-237	210,-	962-237R	57,-	962-337R	35,-	962-437R	20,-	962-637R	16,-
200 g	963-238	210,-	962-238R	57,-	962-338R	35,-	962-438R	20,-	962-638R	16,-
500 g	963-239	210,-	962-239R	57,-	962-339R	35,-	962-439R	20,-	962-639R	16,-
1 kg	963-241	210,-	962-241R	57,-	962-341R	35,-	962-441R	20,-	962-641R	16,-
2 kg	963-242	465,-	962-242R	70,-	962-342R	43,-	962-442R	25,-	962-642R	17,-
5 kg	963-243	465,-	962-243R	70,-	962-343R	43,-	962-443R	25,-	962-643R	17,-
10 kg	963-244	465,-	962-244R	70,-	962-344R	43,-	962-444R	25,-	962-644R	17,-
20 kg	963-245	1160,-	962-245R	590,-	962-345R	55,-	962-445R	28,-	962-645R	22,-
50 kg	963-246	1360,-	962-246R	660,-	962-346R	64,-	962-446R	39,-	962-646R	24,-
100 kg	-	-	-	-	-	-	962-591R*	116,-	962-691R	63,-
200 kg	-	-	-	-	-	-	962-592R*	116,-	962-692R	63,-
500 kg	-	-	-	-	-	-	962-593R*	116,-	962-693R	63,-
1000 kg	-	-	-	-	-	-	-	-	962-694R	136,-
2000 kg	-	-	-	-	-	-	-	-	962-695R	250,-
1 mg-500 mg	-	-	962-250R	370,-	962-350R	190,-	962-450R	100,-	962-650R	63,-
1 mg-50 g	963-201	1180,-	962-201R	610,-	962-301R	315,-	962-401R	167,-	962-601R	106,-
1 mg-100 g	963-202	1290,-	962-202R	630,-	962-302R	340,-	962-402R	178,-	962-602R	112,-
1 mg-200 g	963-203	1490,-	962-203R	690,-	962-303R	395,-	962-403R	199,-	962-603R	125,-
1 mg-500 g	963-204	1580,-	962-204R	720,-	962-304R	420,-	962-404R	210,-	962-604R	131,-
1 mg-1 kg	963-205	1680,-	962-205R	770,-	962-305R	450,-	962-405R	220,-	962-605R	137,-
1 mg-2 kg	963-206	2190,-	962-206R	820,-	962-306R	495,-	962-406R	250,-	962-606R	152,-
1 mg-5 kg	963-207	2450,-	962-207R	850,-	962-307R	530,-	962-407R	265,-	962-607R	160,-
1 mg-10 kg	963-208	2790,-	962-208R	880,-	962-308R	560,-	962-408R	285,-	962-608R	167,-
1 g-50 g	963-215	850,-	962-215R	270,-	962-315R	129,-	962-415R	67,-	962-615R	42,-
1 g-100 g	963-216	940,-	962-216R	290,-	962-316R	155,-	962-416R	77,-	962-616R	49,-
1 g-200 g	963-217	1140,-	962-217R	350,-	962-317R	205,-	962-417R	98,-	962-617R	61,-
1 g-500 g	963-218	1240,-	962-218R	385,-	962-318R	230,-	962-418R	109,-	962-618R	68,-
1 g-1 kg	963-219	1350,-	962-219R	410,-	962-319R	260,-	962-419R	119,-	962-619R	74,-
1 g-2 kg	963-220	1900,-	962-220R	470,-	962-320R	320,-	962-420R	151,-	962-620R	89,-
1 g-5 kg	963-221	2230,-	962-221R	495,-	962-321R	360,-	962-421R	166,-	962-621R	96,-
1 g-10 kg	963-222	2590,-	962-222R	530,-	962-322R	390,-	962-422R	182,-	962-622R	104,-

Additional costs for preparation, overhaul and adjustment before the calibration	KERN	Price excl. of VAT ex works €
Preparation of weights (e.g. cleaning, etc.)		
Single weight	969-001R	3,-
Weight set	969-002R	16,-
Subsequent services are carried out after confirmation		
Continued overhaul of weights (e.g. wet-cleaning, markings, repair, special packaging, adjustment E1 (DAkkS only), E2 ...)	969-005R	T & M basis
Adjustment, per weight only available for weights with adjustment chamber (F1-M3)	969-010R	12,-
Second calibration after adjustment or substitution, per weight		
Class E1	969-210R	40,-
Class E1 incl. volume determination	969-211R	80,-
Class E2	969-310R	14,-
Class F1/F2	969-410R	14,-
Class M1-M3	969-610R	14,-
Testing of magnetic properties according to OIML R 111:2004, per weight	961-115(R)	12,-
Calibration of NON-OIML test weights, additional price per weight	-	8,-

KERN DAkkS Express Service	
DAkkS standard service Class E2-M3	4 working days
DAkkS standard service Class E1, 1 mg-500 mg, and recalibration 1 g-10 kg with a known volume	10 working days
Class E1, ≥ 1 g, incl. volume determination (new weights)	15 working days



DAkkS Express service in 48 hours except for class E1

- Urgent order is received at KERN by 12:00 noon at the latest
- Ready for shipping at KERN within two working days, at 12:00 noon
- Return by standard parcel service or express shipping (Costs and processing time on request)
- Additional cost for DAkkS Express Service, for each KERN test weight KERN KERN 962-115 € 20,-
- For Express shipping, see page 214

Verification prices for test weights and (crane) scales

Class acc. → OIML R 111:2004	E2 with verification certificate		F1/F2 with verification certificate		M1 with verification certificate	
	Nominal value ↓ KERN	Price excl. of VAT ex works €	KERN	Price excl. of VAT ex works €	KERN	Price excl. of VAT ex works €
1 mg	952-351	47,-	952-451	41,-	952-651	28,-
2 mg	952-352	47,-	952-452	41,-	952-652	28,-
5 mg	952-353	47,-	952-453	41,-	952-653	28,-
10 mg	952-354	47,-	952-454	41,-	952-654	28,-
20 mg	952-355	47,-	952-455	41,-	952-655	28,-
50 mg	952-356	47,-	952-456	41,-	952-656	28,-
100 mg	952-357	47,-	952-457	41,-	952-657	28,-
200 mg	952-358	47,-	952-458	41,-	952-658	28,-
500 mg	952-359	47,-	952-459	41,-	952-659	28,-
1 g	952-331	47,-	952-431	41,-	952-631	28,-
2 g	952-332	47,-	952-432	41,-	952-632	28,-
5 g	952-333	47,-	952-433	41,-	952-633	28,-
10 g	952-334	47,-	952-434	41,-	952-634	28,-
20 g	952-335	47,-	952-435	41,-	952-635	28,-
50 g	952-336	47,-	952-436	41,-	952-636	28,-
100 g	952-337	53,-	952-437	41,-	952-637	28,-
200 g	952-338	53,-	952-438	43,-	952-638	28,-
500 g	952-339	53,-	952-439	43,-	952-639	28,-
1 kg	952-341	53,-	952-441	43,-	952-641	28,-
2 kg	952-342	60,-	952-442	47,-	952-642	30,-
5 kg	952-343	60,-	952-443	47,-	952-643	30,-
10 kg	952-344	60,-	952-444	47,-	952-644	37,-
20 kg	952-345	69,-	952-445	49,-	952-645	43,-
50 kg	-	-	952-446	59,-	952-646	44,-
1 mg-500 mg	952-350	235,-	952-450	124,-	952-650	78,-
1 mg-50 g	952-301	390,-	952-401	205,-	952-601	130,-
1 mg-100 g	952-302	420,-	952-402	220,-	952-602	138,-
1 mg-200 g	952-303	475,-	952-403	245,-	952-603	154,-
1 mg-500 g	952-304	510,-	952-404	255,-	952-604	161,-
1 mg-1 kg	952-305	530,-	952-405	270,-	952-605	169,-
1 mg-2 kg	952-306	610,-	952-406	305,-	952-606	187,-
1 mg-5 kg	952-307	660,-	952-407	330,-	952-607	198,-
1 mg-10 kg	952-308	690,-	952-408	350,-	952-608	205,-
1 g-50 g	952-315	156,-	952-415	90,-	952-615	59,-
1 g-100 g	952-316	185,-	952-416	95,-	952-616	63,-
1 g-200 g	952-317	240,-	952-417	121,-	952-617	75,-
1 g-500 g	952-318	280,-	952-418	134,-	952-618	83,-
1 g-1 kg	952-319	300,-	952-419	147,-	952-619	92,-
1 g-2 kg	952-320	375,-	952-420	186,-	952-620	109,-
1 g-5 kg	952-321	415,-	952-421	205,-	952-621	119,-
1 g-10 kg	952-322	460,-	952-422	225,-	952-622	128,-

KERN verification delivery time	
Standard verification service Class E2 - M1	6 working days

Additional costs for preparation, overhaul and adjustment before the verification	KERN	Price excl. of VAT ex works €
--	------	--

Preparation of weights (e.g. cleaning, etc.)		
Single weight	969-008R	3,-
Weight set	969-009R	16,-

Subsequent services are carried out after confirmation		
Continued overhaul of weights (e.g. wet-cleaning, markings, repair, special packaging, adjustment E2 ...)	969-005R	T & M basis

Adjustment, per weight only available for weights with adjustment chamber (F1/F2 - M1)	969-010R	12,-
---	----------	------

Verification after adjustment or substitution, per weight		
Class E2	969-310R	14,-
Class F1/F2	969-410R	14,-
Class M1	969-610R	14,-

Verification prices for balances	Reverification	Price excl. of VAT ex works €
	KERN	
Accuracy class I (precision balances) ¹⁾		
[Max] ≤ 5 kg ¹⁾	950-101R	210,-
[Max] > 5 kg ¹⁾	950-102R	270,-
Accuracy class II (precision balances) ¹⁾		
[Max] ≤ 5 kg ¹⁾	950-116R	106,-
[Max] > 5 kg - 50 kg ¹⁾	950-117R	129,-
[Max] > 50 kg - 350 kg ¹⁾	950-118R	200,-
Accuracy class III-IV ¹⁾		
Bench scales and industrial scales (excl. crane scales)		
[Max] ≤ 5 kg ¹⁾	950-127R	101,-
[Max] > 5 kg - 50 kg ¹⁾	950-128R	101,-
[Max] > 50 kg - 350 kg ¹⁾	950-129R	162,-
[Max] > 350 kg - 1500 kg ¹⁾	950-130R	235,-
[Max] > 1500 kg - 2900 kg ¹⁾	950-131R	330,-
[Max] > 2900 kg - 6000 kg ¹⁾	950-132R	510,-
Crane scales		
[Max] > 50 kg - 350 kg ¹⁾	950-129HR	176,-
[Max] > 350 kg - 1500 kg ¹⁾	950-130HR	290,-
[Max] > 1500 kg - 2900 kg ¹⁾	950-131HR	420,-
[Max] > 2900 kg - 6000 kg ¹⁾	950-132HR	640,-
[Max] > 6000 kg - 12000 kg ¹⁾	950-133HR	1020,-

¹⁾ Processing time 4 working days, ²⁾ Processing time 15 working days, ¹⁾²⁾ Preparation of reverification of balances, 969-006R, € 20,-

The force gauge

Accredited calibration with DAkkS calibration certificate for force gauges

The KERN calibration laboratory is at your side when you need to calibrate DAkkS reliably.

From the transducer to the full measuring chain, we are happy to take care of traceable calibration of your test equipment for you. Our accreditation includes the calibration of tensile and pressure force up to 5 kN according to the standards DIN EN ISO 376 and DKD-R 3-3, each with the Newton (N) display unit for a complete measuring chain (situation A) or voltage ratio/transmission coefficient (mV/V, situation B).

Below you will find a comparison of which standard meets which criteria:

Comparison of DIN EN ISO 376 and DKD-R 3-3		
	ISO 376	DKD-R 3-3
Standardization	ISO standard (internationally standardized)	Standard of the DKD (Germany)
Measuring equipment	Force transducers and complete measuring chains	Force transducers and complete measuring chains
Area of application	Specifically force gauges for the testing of testing equipment	General force gauges
Number of power stages	8	5
Classification/Assessment	Classification in classes 00; 0,5; 1 and 2	None in standard
Test sequences	Fixed procedure	Sequences A, B, C, D possible Standard is sequence A B, C and D are reduced sequences, relevant previous knowledge is necessary
Summary	Higher-quality calibration, as 8 force levels are calibrated	High-quality calibration, reduced sequences with less effort possible

We can offer you a calibration solution for the following situations:

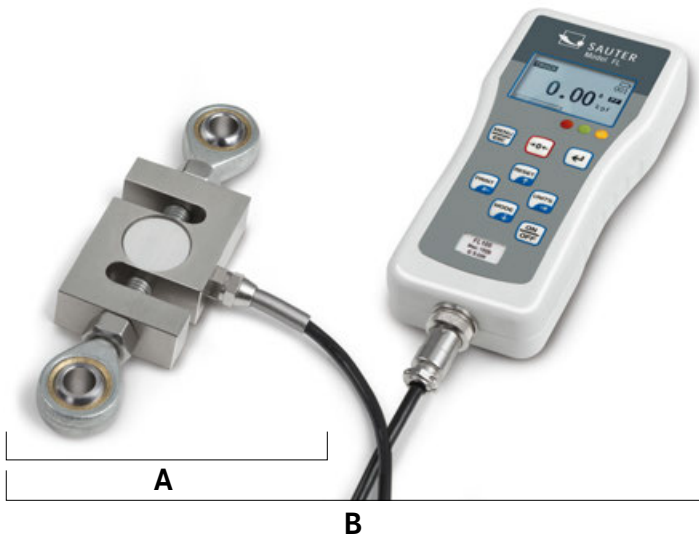

Situation A:

Force transducer (mV/V)

► See also tables, right side

Situation B:

Complete force gauge (N), consisting of transducer, amplifier and display

You can find further information on this topic at: www.kern-lab.com

KERN & SOHN GmbH
Akkreditiertes Kalibrierlabor seit 1994
 Accredited calibration laboratory since 1994

Ihr Partner für Kalibrierdienstleistungen, Prüfmittelmanagement und Beratung.
 Your partner for calibration services, test equipment management and support.

Mitglied in / member of the

Deutscher Kalibrierdienst

Sample
D.K. 1949-01-00
2020-01

Kalibrierschein Sample-2020-0111
Calibration certificate

Kalibrierzeichen
Calibration mark

Gegenstand Objekt	Kraftmessgerät Force gauge Max 200 N, d= 0,001 N	Dieser Kalibrierschein dokumentiert die Rückführung auf nationale Normale zur Darstellung der Erhebten in Übereinstimmung mit dem internationalen Einheitsystem (SI).
Hersteller Manufacturer	Höttinger Baldwin Messtechnik GmbH Darmstadt Deutschland	Die DAkkS ist Unterzeichner der multilateralen Übereinkommen der European cooperation for Accreditation (EA) and der International Laboratory Accreditation Cooperation (ILAC) zur gegenseitigen Anerkennung der Kalibrierscheine.
Typ Type	Z30A/200N	Für die Einhaltung einer angemessenen Frist zur Wiederholung der Kalibrierung ist der Benutzer verantwortlich.
Fabrikate/Serien-Nr. Serial number	185013042 Inventar-Nr.: KR16	<small>This calibration certificate documents the</small>
Auftraggeber Customer	Müllermann GmbH Musterstraße 1 12345 Musterstadt Deutschland	

Messwerte (Druckkraft) / Measured values (compression force)

Ausrichtung	Ausgangsposition / initial position		120°				340°	
Winkel	R1	R2	R3	R4	R5	R6		
Kraft								
0 N	0,000 N	0,000 N	0,000 N	0,000 N	0,000 N	0,000 N	0,000 N	0,000 N
20,0 N	20,001 N	20,001 N	20,001 N	20,001 N	20,002 N	20,002 N	20,002 N	20,002 N
40,0 N	40,003 N	40,003 N	40,003 N	40,003 N	40,002 N	40,004 N	40,003 N	40,003 N
60,0 N	60,004 N	60,004 N	60,004 N	60,004 N	60,003 N	60,005 N	60,004 N	60,004 N
80,0 N	80,005 N	80,004 N	80,004 N	80,005 N	80,006 N	80,006 N	80,004 N	80,004 N
100,0 N	100,005 N	100,004 N	100,003 N	100,004 N	100,006 N	100,006 N	100,004 N	100,004 N
120,0 N	120,005 N	120,004 N	120,003 N	120,003 N	120,006 N	120,006 N	120,004 N	120,004 N
160,0 N	159,999 N	159,998 N	159,998 N	159,998 N	160,000 N	159,999 N	159,999 N	159,999 N
200,0 N	199,997 N	199,998 N	199,998 N	199,998 N	199,998 N	199,999 N	199,999 N	199,999 N
0 N	0,001 N	0,001 N						

Messergebnisse (Druckkraft) / Measurement results (compression force)

Aus den oben aufgeführten Messwerten ergeben sich die folgenden Messergebnisse:
 The following measurement results are calculated using the measured values above:

Rel. Kalibrierabweichung / Rel. cal. max. load error: $k_1 = 0,001\%$
 Rel. Kreisabweichung / Rel. circle error: $k_2 = 0,001\%$
 Rel. Nullpunktabweichungen / Rel. zero error: $k_3 = 0,001\%$ (R1), 0,001% (R2), 0,000% (R3/R4), 0,001% (R5/R6)

Kraft	arith. Mittelwert \bar{x}	rel. Wiederhol- präzision σ	rel. Vergleichs- präzision σ	rel. Δ - Genauigkeit \pm
Force				
20,0 N	20,001 N	0,000%	0,005%	0,002%
40,0 N	40,003 N	0,000%	0,002%	0,002%
60,0 N	60,004 N	0,000%	0,002%	0,002%
80,0 N	80,005 N	0,001%	0,002%	0,002%
100,0 N	100,005 N	0,001%	0,003%	0,001%
120,0 N	120,005 N	0,001%	0,003%	0,001%
160,0 N	159,999 N	0,000%	0,001%	0,000%
200,0 N	199,998 N	0,001%	0,001%	-

Sample
D.K. 1949-01-00
2020-01

DAkkS Calibration certificate for force-measuring devices (extract).

Prices for DAkkS calibration of force gauges and force transducers

Situation A: Force transducer (voltage ratio, in mV/V)* ^{1,2}					
ISO 376 (8 stages)			DKD-R 3-3 (5 stages, sequence A)		
KERN	Measuring range	Price € ex works excl. of VAT	KERN	Measuring range	Price € ex works excl. of VAT
Tensile force:					
963-161V (R)	≤ 500 N	181,-	963-161V (R)	≤ 500 N	168,-
963-162V (R)	≤ 2 kN	215,-	963-162V (R)	≤ 2 kN	198,-
963-163V (R)	≤ 5 kN	280,-	963-163V (R)	≤ 5 kN	260,-
Compression force:					
963-261V (R)	≤ 500 N	181,-	963-261V (R)	≤ 500 N	168,-
963-262V (R)	≤ 2 kN	215,-	963-262V (R)	≤ 2 kN	198,-
963-263V (R)	≤ 5 kN	280,-	963-263V (R)	≤ 5 kN	260,-
Tensile and Compression force:					
963-361V (R)	≤ 500 N	300,-	963-361V (R)	≤ 500 N	280,-
963-362V (R)	≤ 2 kN	365,-	963-362V (R)	≤ 2 kN	335,-
963-363V (R)	≤ 5 kN	480,-	963-363V (R)	≤ 5 kN	440,-

Situation B: Complete force gauge (in N)* ²					
ISO 376 (8 stages)			DKD-R 3-3 (5 stages, sequence A)		
KERN	Measuring range	Price € ex works excl. of VAT	KERN	Measuring range	Price € ex works excl. of VAT
Tensile force:					
963-161I (R)	≤ 500 N	149,-	963-161 (R)	≤ 500 N	135,-
963-162I (R)	≤ 2 kN	182,-	963-162 (R)	≤ 2 kN	165,-
963-163I (R)	≤ 5 kN	250,-	963-163 (R)	≤ 5 kN	225,-
Compression force:					
963-261I (R)	≤ 500 N	149,-	963-261 (R)	≤ 500 N	135,-
963-262I (R)	≤ 2 kN	182,-	963-262 (R)	≤ 2 kN	165,-
963-263I (R)	≤ 5 kN	250,-	963-263 (R)	≤ 5 kN	225,-
Tensile and Compression force:					
963-361I (R)	≤ 500 N	270,-	963-361 (R)	≤ 500 N	245,-
963-362I (R)	≤ 2 kN	330,-	963-362 (R)	≤ 2 kN	300,-
963-363I (R)	≤ 5 kN	445,-	963-363 (R)	≤ 5 kN	405,-

Factory calibration for force

Situation A: Force transducer (voltage ratio, in mV/V)* ^{1,2}			Situation B: Complete force gauge (in N)* ²		
KERN	Measuring range	Price € ex works excl. of VAT	KERN	Measuring range	Price € ex works excl. of VAT
Tensile force:					
961-161V (R)	≤ 500 N	168,-	961-161 (R)	≤ 500 N	135,-
961-162V (R)	≤ 2 kN	198,-	961-162 (R)	≤ 2 kN	165,-
961-163V (R)	≤ 5 kN	260,-	961-163 (R)	≤ 5 kN	225,-
961-164V (R)	≤ 20 kN	330,-	961-164 (R)	≤ 20 kN	295,-
961-165V (R)	≤ 50 kN	330,-	961-165 (R)	≤ 50 kN	295,-
961-166V (R)	≤ 250 kN	360,-	961-166 (R)	≤ 120 kN	325,-
Compression force:					
961-261V (R)	≤ 500 N	168,-	961-261 (R)	≤ 500 N	135,-
961-262V (R)	≤ 2 kN	198,-	961-262 (R)	≤ 2 kN	165,-
961-263V (R)	≤ 5 kN	260,-	961-263 (R)	≤ 5 kN	225,-
961-264V (R)	≤ 20 kN	330,-	961-264 (R)	≤ 20 kN	295,-
961-265V (R)	≤ 50 kN	330,-	961-265 (R)	≤ 50 kN	295,-
961-266V (R)	≤ 250 kN	360,-	961-266 (R)	≤ 120 kN	325,-
Tensile and Compression force:					
961-361V (R)	≤ 500 N	280,-	961-361 (R)	≤ 500 N	245,-
961-362V (R)	≤ 2 kN	335,-	961-362 (R)	≤ 2 kN	300,-
961-363V (R)	≤ 5 kN	440,-	961-363 (R)	≤ 5 kN	405,-
961-364V (R)	≤ 20 kN	475,-	961-364 (R)	≤ 20 kN	440,-
961-365V (R)	≤ 50 kN	475,-	961-365 (R)	≤ 50 kN	440,-
961-366V (R)	≤ 250 kN	520,-	961-366 (R)	≤ 120 kN	485,-

(R): Recalibration

For each force gauge without interface or from other manufacturers we charge a surcharge of € 10,- for the additional effort.

*1 Compatibility with our amplifiers required

*2 Installation in our measuring equipment required

Factory calibration certificates

As DAkkS calibration certificates cannot be offered for all measuring devices or measurement sizes, or where it is not customary, we then offer factory calibration certificates. These calibration certificates meet international standards and are particularly suitable as proof of exacting calibration in the monitoring of your checking equipment, for example:

- Mechanical balances (spring balances, etc.)
- Force-measuring devices up to 250 kN (see also page 221)
- Measuring devices for layer thickness 0 µm – 2000 µm
- Hardness testing devices in accordance with Leeb tests
- Ultrasonic material thickness testing device 25 mm - 300 mm

We carry out calibrations independent of brand. In order to avoid any unnecessary delays when processing your order, please send us the technical documents and necessary accessories with the checking device. Calibration time 4 working days.

For up-to-date information on test services for further measuring variables please see p. 221 or visit our website www.kern-lab.com

KERN	Measuring device	Measuring range	Price excl. of VAT ex works €
Factory calibration			
961-110	Coating thickness	≤ 2000 µm F or N	120,-
961-112	Coating thickness	≤ 2000 µm FN	170,-
961-113	Wall thickness (ultra sound)	≤ 300 mm (in stainless steel)	120,-
961-114	Wall thickness (Test blocks)	≤ 300 mm	150,-
961-170	Hardness comparison plate (Shore)	For sets up to 7 plates	95,-
961-131	Hardness tester (Leeb)	400 - 800 HLD	120,-
961-132	Hardness comparison plate (Leeb)	Hardness comparison plate (for Leeb durometer)	120,-
961-270	Hardness (UCI)	200 - 800 HV	260,-
961-150	Length	≤ 300 mm	120,-
961-190	Light	≤ 200000 lx	165,-
961-100	Mechanical balances/spring balances	≤ 5 kg	72,-
961-101	Mechanical balances/spring balances	> 5 - 50 kg	88,-
961-102	Mechanical balances/spring balances	> 50 - 350 kg	105,-
961-103	Mechanical balances/spring balances	> 350 - 1500 kg	165,-
961-167	Digital dynamometer KERN MAP	≤ 130 kg	120,-
961-120 (R)	Torque wrench test devices	1 Nm - 200 Nm	170,-
Additional services			
962-116	Express service with 48 hour delivery		50,-/instrument

(R): Recalibration

For each force gauge without interface or from other manufacturers we charge a surcharge of € 10,- for the additional effort.

KERN & Sohn GmbH
 Kalibrationslabor seit 1994.
 Calibration laboratory since 1994.
 Ihr Partner für Kalibrationsleistungen, Prüfmittelmanagement und Beratung.
 Your partner for calibration services, test equipment management and support.

Kalibrierschein M8-123-KERN-2016-08
 Calibration certificate

Kalibriergegenstand Drehmomentschlüssel-Kalibriereinrichtung
 Torque wrench calibration device
 Max. 1 Nm d+ 0,0001 Nm

Hersteller SAUTER GmbH
 Ziegen 1
 72236 Balingen
 Deutschland

Typ DB 1-4
Typ DB 1-4

Fabrikat/Serien-Nr. DB1234567
Serial number DB1234567

Inventurnummer -
Inventory number -

Auftraggeber Musterfirma GmbH
Customer Musterfirma GmbH
 12345 Musterstadt
 Deutschland

Auftragsnummer 2016-12345678
Order No. 2016-12345678

Messungsergebnisse - Rechtsdrehmoment
 Measurement results - clockwise torque

Messung	Referenz-Drehmoment	Anzeige	Abweichung	Messunsicherheit	Toleranz	Konformität
Measurement	Reference torque	Indication	Error	meas. uncertainty	Tolerance	Conformity
1	0,2 Nm	0,1998 Nm	-0,0002 Nm	0,0000 Nm	0,0000 Nm	✓
2	0,6 Nm	0,6004 Nm	+0,0004 Nm	0,0000 Nm	0,0000 Nm	✓
3	1,0 Nm	1,0004 Nm	+0,0004 Nm	0,0000 Nm	0,0000 Nm	✓

Messungsergebnisse - Linksdrehmoment
 Measurement results - anticlockwise torque

Messung	Referenz-Drehmoment	Anzeige	Abweichung	Messunsicherheit	Toleranz	Konformität
Measurement	Reference torque	Indication	Error	meas. uncertainty	Tolerance	Conformity
1	0,2 Nm	0,2004 Nm	+0,0004 Nm	0,0000 Nm	0,0000 Nm	✓
2	0,6 Nm	0,6002 Nm	+0,0002 Nm	0,0000 Nm	0,0000 Nm	✓
3	1,0 Nm	0,9998 Nm	-0,0002 Nm	0,0000 Nm	0,0000 Nm	✓

1) Es gilt: [Abweichung] = [Anzeige] - [Referenz-Drehmoment] (bzw. [Indikator] - [Referenz torque])
 2) Angegeben ist die erweiterte Messunsicherheit, die sich aus der Standardunsicherheit durch Multiplikation mit dem Erweiterungsfaktor k=2 ergibt. Sie wurde gemäß DIN EN ISO 17025 in Anlehnung an DIN EN ISO 9001:2015 unter Angabe von für diesen Gegenstand spezifischen Werten für die typischerweise Konformität bei zunehmender Belastung (Belastungsgrenze, Grenzwert) und Vergleichsprüfung, DfF.

Factory calibration certificate for torque wrench test devices
 (extract from the factory calibration certificate)
 Further details on the internet at www.kern-lab.com

A**Accuracy classes for test weights**E, F, M ▶ *Error limit classes***Adjusting of measurement equipment**

Precise setting of a measurement value via a professional intervention in the measurement system.

Adjusting the weighing range of a balance

Either with the external test weight via the **adjusting program CAL**, or with the **internal automatic adjustment** resp. **adjusting switch**. It is necessary with variations in temperature, a change of environmental conditions, change of location, etc.

Recommended as a daily check routine.

Alibi memory

For weighings where verification is mandatory, and which are to be analysed and processed by a PC (e.g. printing out a packing list using a PC instead of a printer connected directly to the balance) electronic archiving is required by the metrological authorities by a verifiable data memory which cannot be manipulated. Alibi memories from KERN fulfil this requirement. They are for paperless archiving of weighing results. For KERN products the alibi memory is fitted inside the balance, right between where the weight is determined and the output to the PC.

All data transferred to the PC is stored with date, time and all important weights for at least three months. These stored data strings can be displayed on the balance at any time. The data in the alibi memory can be deleted, but not changed.

Application accuracy

Allowance for measuring uncertainty during practical use of a balance. Is given in the appendix to the DKD calibration certificate.

ATEX

Derived from **AT**mosphère **EX**plosibles. (explosive atmosphere). A synonym for EU guidelines, which controls the quality and use of equipment in hazardous industrial environments, where there is explosion danger, e.g. by handling of flammable substances, which are present in high concentrations in the form of gas, mist, vapour or dust. See also 2014/34/EU as well as 1999/92/EU.

B**Balances which are verified/not approved for verification**

Metrologically almost identical. For verified balances certain details are regulated by law, e.g. software changes and additional markings.

C**CAL**

Adjusting the balance is triggered with an external test weight by using the CAL key on the key pad or on the touch display of the display device or the CAL menu option. This will guarantee the consistent high accuracy of the balance.

Calibration of measurement equipment

Determination of the precision of a measurement value without intervention in the measurement system. Example: to check a balance you load a ▶ **test weight** upon it. The term "Calibrating" was formerly also used for ▶ **Adjusting**.

Calibration Certificate DKD/DAkks

See product group 18 "Calibration service"

Calibration or verification

DAkks-Calibration is possible for every balance in perfect condition. DAkks calibration (DKD) is a private service monitored by the state for ensuring high quality requirements according to ISO 9000ff and others, e.g. in production or research. **Verifying (conformity assessment)** is only possible for type-approved balances marked with the green **M** ▶ **Verification**

Commercial error limit

Permitted tolerance (plus and minus) of measuring devices where verification is mandatory when used within their verification validity period. This tolerance is double the permissible error limit, in so far as this is not specified otherwise in the Weights and Measures Act).

Conformity assessment

Procedure for confirming warranted characteristics in accordance with recognised rules. For balances this relates to verification.

Conformity declaration from the manufacturer

The manufacturer declares that the product fulfils the applicable EU directives. With electronic balances this is always in conjunction with the CE mark.

Control of measuring equipment in the QM system in conjunction with quality standards

An organisation certified to a quality standard such as DIN EN ISO 9001 ff. e.g. a production plant is obliged to adhere to a defined quality standard within the framework of its quality management system. To do this, it is imperative to have a measurement equipment which is working accurately. Chapter 7.1.5 "Resources for monitoring and measuring" of DIN EN ISO 9001:2015-11 states that measuring equipment must be calibrated at defined intervals and before use. The measurement devices and measurement standards needed to do this must:

- be traced back to international or national standards.
(▶ **Traceability to the National Standard**)
 - their uncertainty of measurement must be known- they must be marked with a clear identification
 - the test must be documented
- The ▶ **DAkks calibration (DKD)** fulfils all these requirements.

Conventional mass of weights

The problem is the air movement, which makes the weight appear lighter. In order to avoid this "distortion" in daily use, all weights are adjusted to the unit specifications given in R111, e.g. it is accepted that: material density of the weights is 8000 kg/m³, air density is 1.2 kg/m³ and measuring temperature is 20°C.

Counting resolution

The counting resolution is calculated in points from the ratio of the weighing range [Max] divided by the smallest part weight. It is a statement of counting accuracy.

D**DAkks = German accreditation authority**

▶ **Calibration Certificate DKD/DAkks**

See product group 18 "Calibration service"

Data interface

To connect the balance to a printer, PC, network or a second balance. Typical interfaces are, for example, RS-232, RS-485, USB, Bluetooth, LAN, Digital I/O, DUAL, LAN etc. The interface parameters can be set using the balance. The interfaces available are stated in the model description.

Density determination

One of the main areas of application for laboratory balances is determining densities, e.g. determining the specific weight of liquids and solids. To do this you will need a highly accurate precision or analytical balance and a density set. It is particularly convenient if the balance can calculate and display the density right away.

It has become apparent that by means of weighing when in the process of determining the density of liquids and solids according to the buoyancy method particularly accurate results can be obtained (Archimedes' principle).

- a) Density determination of liquids: By means of measuring the buoyancy with a glass plummet with known volume immersed in the liquid to be measured
- b) Density determination of solid bodies:

$$\rho = \frac{A}{A-B} \cdot \rho_0$$

ρ = Density of sample

A = Weight of sample in air

B = Weight of sample in auxiliary liquid

ρ_0 = Density of the auxiliary liquid

Applications:

- Pre-packaged goods control, whenever a product is sold according to its volume [cm³]. This volume is calculated with weight [g] : density [g/cm³].
- Materials analysis

DMS = Strain gauge



An electrical resistor strip that is glued to an elastic deforming body made of aluminium. As the strain gauge is mechanically deformed its resistance value changes, allowing the measured value to be calculated.

Draught shield

Required for balances with ► **Readout** $d \leq 1$ mg, to avoid disturbing air movements.

Dual-range balance

As the load increases, the balance switches automatically to the next largest range, for both, weighing range [Max] as well as readout [d].

E

Error limit classes for test weights according to EU directive OIML R111

For further details, see product group 17 "Test weights"

F

FACTORY

These options can only be carried out at KERN factory.

FORCE = Electromagnetic force compensation



A counterforce is created by means of a coil in a permanent magnet. This counterforce is the same as the load of the weight being measured on the scale and therefore equalising. The measured value is calculated via the change in the coil current.

G

GLP = Good Laboratory Practice

► **ISO/GLP**

Gravitational acceleration

► **Gravitational force**

Gravitational force

very important influence for precise electronic balances. Due to the varying influence balances have to be ► **adjusted at the location of use.**

H

HACCP

= **Hazard Analysis and Critical Control**

Points (HACCP) The HACCP concept is a preventative system, which is designed to guarantee the safety of foodstuffs EC regulation 852/2004 mandates the use of the HACCP concept for all companies which are involved in production, processing and sales of foodstuffs.

I

ISO 9000ff/DIN EN ISO 9000ff

Quality Management System in the form of a DIN Norm for quality assurance in a factory.

ISO calibration/ISO certificate = factory calibration certificate

Testing measurement devices for accuracy in accordance with a procedure which is recognised, but not accredited.

ISO/GLP record keeping



Quality Assurance Systems demands record keeping of weighing results and correct adjusting of the balance, giving details of date, time and balance identification. The easiest way to obtain this documentation is by means of a connected printer.

J

Junction Box

For connection and simple corner adjustment of several load cells.

K

KCP

KCP is an universal communication protocol between laboratory balances, industrial scales or other measuring instruments and digital devices, such as a computer, server or process management system. Due to the universal protocol structure, one measuring instrument can be replaced by another without adapting the communication interface.

L

Linearity/Precision

Greatest deviation of the weight displayed of a balance with regard to the value of the respective test weight in terms of plus and minus across the whole weighing range.

M

Minimum load [Min]

Lower limit of the verifiable weighing range. Is marked on the verification mark. The function of the balance is also given below the minimum load.

Minimum sample weight

Indicates the smallest weight which can be determined, depending on the process accuracy required.

N

Newton

Newton (N) is the unit for physical force values. A Newton is the force required to accelerate a 1 kg mass at rest to a speed of 1 m/s within one second.

Notified body

Neutral and independent, predominantly government bodies, which are formally appointed by the EC. They are engaged in the field of verification for conformity evaluations (initial verification) and type-approval test within the scope of type approvals.

O

Optimisation of reference weight (when piece counting)

See product group 9 "Counting balances/ Counting systems".

P

Percentage determination



Example: Reference weight prior to drying: 50g = balance display 100%. After drying 40g = balance display 80% absolute (dry mass) or 20% relative (humidity).

Permissible ambient temperature

Measuring errors are possible if you use the balances outside the permitted specified ambient temperature range. With verified balances this is stated on the identification plate.

PLU (Price Look Up)

This refers to a data memory in price-computing retail scales for the base price of sales items.

Pre-packaging legislation (FPVO)

Ensures that pre-packed goods are filled correctly, for example, in food industry. The Weights and Measures Act governs the permissible weight and volume tolerances.

PRE-TARE

Entering and saving a tare weight (e.g. container weight) through weighing or manual entry using the balance keypad before the actual weighing process. When you subsequently place the tare container on the balance, the balance will show zero immediately – saves time. Particularly useful e.g. for checking fill levels

Proof of compatibility

This documents the verification compatibility for combinations of weighing modules such as display devices, load cells and connecting elements.

R**Readout [d]**

Smallest readable weight increment on a digital display.

Recalibration

Periodic checking of the precision of measurement equipment/checking equipment (e.g. balances/weights) to control accuracy,
► **Control of measurement equipment**

Reference weight (when piece counting)

See product group 9 "Counting balances/Counting systems".

Reproducibility (standard deviation)

Sequenced measure of conformity in repeated weighing (e.g. balances) subject to the same conditions. Mostly 1 [d] or less. Quality feature.

Resolution of a balance

The resolution is calculated from the weighing range [Max] divided by the readout [d], e. g. [Max] 420 g : [d] 0.001 g = 420,000 points. The resolution is a quality feature – the higher, the better.

S**SC-TECH = Single-Cell-Technology**

► **FORCE**. The load cell consists of a single aluminium block, which gives a very high measurement quality.

Semi-micro balance

Analytical balance with a readout [d] = 0,01 mg

Smallest part weight when counting

The smallest piece weight, which a balance can accept for piece counting. For the relevant model, enter "g/piece" in the product data table.

T**T-FORK = Tuning fork principle**

A resonating body (like a tuning fork) is electromagnetically excited, causing it to oscillate. The measured value is calculated via the change in frequency corresponding to the load of the weight being measured on the scale.

Taring, automatic

► **PRE-TARE**

Taring, subtractive

The available weighing range of a balance is reduced by the value of the tare load. Example: weighing range of a balance Max 6000g, Tare (= container) 470g, available weighing range 5530g.

Test weight, external (previously calibration weight)

For adjusting or checking the balance accuracy ► **Adjusting the weighing range**. The external test weight can be DAkkS calibrated at any time, even afterwards, see product group 18 "Calibration Service".

Test weight, internal

Like test weight external, but installed in the balance and powered.

Totalising

Various individual weighings are added automatically to aggregate, e.g. all individual weighings of a batch.

Traceability to the National Standard

A pre-requisite for every perfect measurement is the validated comprehensive proof that the measuring equipment can be traced back to the international or national standards. In Germany the statutory binding standards are available from the PTB.

Type approval for balances

Strict process to test whether a balance fulfils the verification requirements. A balance can only be verified, if it has got a type approval from a ► **notified body**.

U**Uncertainty of measurement of a balance (= standard deviation)**

Determined for each balance according to a precisely given test method and documented in the ► **Calibration certificate**. It depends on various factors, both, internal and external. Uncertainty of measurement increases by a rising charge of the balance, see product group 18 "Calibration Service"

V**Verification**

Verification, in accordance with the new terminology "Conformity assessment". Only balances with ► **EC type approval** can be evaluated for conformity. These balances have an identification plate with the metrology marking **M**. The state requires assessment for conformity and this assessment serves as consumer protection. According to EU directive 2014/31/EEC balances must be officially assessed for conformity (calibrated) if they are used as follows:

- in commercial trade when the price of a commodity is determined by weighing.
- in the manufacture of pharmaceuticals in pharmacies and analysis in pharmaceutical and medical laboratories.
- for official purposes.
- in the production of prepackaging.
- in medical applications.

Every balance is tested by KERN and marked with a conformity mark. Its accuracy within the framework of permissible tolerances is thereby confirmed. EU verification applies to all member states of the EU.

Verification classes of balances

Class I – Analytical balance (precision balance), Class II – precision balance, Class III – industrial scale (commercial scale).

Verification of a balance with adjusting program CAL EXT

The adjusting program is sealed with an official mark after the verification. Thus the verification is only valid for the specific location of use. ► **Gravitational force**
To be able to correctly adjust the balance to your location of use, it is necessary to advise the location of use and postcode. See individual model details for the information as to whether verification can be carried out in the factory or at the location of use.

Verification of a balance with automatic internal adjusting CAL INT

The above restrictions in respect of the location of use do not apply, because the automatic internal adjusting works also after verification, therefore it is not sealed. In this case, verification does not depend on the location.

Verification validity for balances

Generally 2 years for all verification classes, for control balances generally 1 year, after expiry the balance has to be re-verified.

Verification value [e]

Measure of the verification tolerance, depending on balance, mostly between 1 [d] and 10 [d] ► **Readout**

W**Weighing range [Max]**

is the working range of the balance. The balance can be loaded up to the specified upper limit.

Sales conditions



All prices are valid as of January 1st 2021 until a new version of the KERN catalogue is released. In Europe, all prices do not include the applicable V.A.T.

At KERN there is no minimum order value. For orders less than € 15.00 there is no re-sale discount available.

Delivery Conditions: we supply ex works Balingen, e.g. the transport costs are invoiced. With our contract logistics partners we always offer you shipping at a good rate. When shipping to islands or other more distant areas, or areas which are difficult to access, the transport costs may possibly be higher, please ask for details. Any goods supplied remain KERN's property until complete payment for the goods sold has been received.



Delivery is usually via courier service.



When you see this symbol by truck, please ask for prices.

Extract from general terms and conditions:

Court of jurisdiction/Legal domicile: 72336 Balingen, Germany;
Commercial register N°: HRB 400865, AG Stuttgart;
Managing director: Albert Sauter

For the full Terms and Conditions, please refer to the website.
www.kern-sohn.com/en/kern/agbs.html

Price changes and product changes are likely in individual cases, due to product modifications as well as error.

Sale or return: within 14 days of purchase. Not valid for order-specific adaptations such as special productions, cable extensions, special weights, etc. or test services such as calibration, verification, etc. Depending on the time and effort involved, there may be processing and storage costs, please ask for details.

Warranty:

- 3 years for products with list price \geq € 400.00
 - 2 years for components as well as products with list price $<$ € 400.00
 - 1 year for pallet truck scales
- Does not apply to consumables such as batteries, rechargeable battery packs, etc.

Balances in areas regulated by law (► Verification) must comply with the commercial error limits during the period of validity for verification – these are usually double the verification permissible error limits. If this period of validity for verification expires, then reverification must be carried out. If, in order to pass the verification, it should be necessary to adjust the balance to comply with the verification permissible error limits, then this does not constitute a warranty claim.

Service



KERN DirectCash: The quick, secure COD procedure for protection against non-payment. With the KERN DirectCash COD system, you can safely deliver orders to end customers with unknown credit rating, with no risk of non-payment. Please request further details on this procedure.

Hire Purchase

Financing is available using KERN hire purchase – easy and convenient. Hire Purchase gives you the option of purchasing any product from our range against a simple monthly installment. The product value is financed over the period of the agreement. On payment of the last installment, the ownership of the contract item automatically transfers from the

contractor to the contractee. The Hire Purchase Agreement can – if you so choose – be set for a period of between one and five years. This package includes the transfer of items as well as the guarantee for the entire transfer period.

Compared with buying the product, KERN hire purchase offers the advantage that the initial financial investment is largely unnecessary. This is particularly relevant when purchasing a number of products, for example when refitting a laboratory, a company department or a hospital ward. In addition the monthly installments constitute a direct cost and the item does not have to be capitalised by the purchaser.

After-Sales-Service



Repair service

Within 1 week at our plant in Balingen, transportation costs are additional. In urgent cases, if requested by customer, a replacement device will be provided until all repairs are completed; please ask.

Price reduction for a new device

If repair costs exceed the current value of the defective device, a new device will be offered for a discount price. This offer is valid only up to 2 years after warranty expiration.

Spare parts service

Usually within 48 hours, transportation costs are additional.

Marketing support



KERN catalogues, brochures, branch prospectuses – your own personalised marketing tools

This catalogue and branch prospectuses are available free of charge. A neutral version of the catalogue, without the KERN address imprint, is also available free of charge for your marketing activities, larger quantities on request.

On demand, your company logo and address can be printed on the back of the KERN catalogue free of charge, larger quantities on request. In this way you have got your own individual marketing tool.

The KERN catalogue and branch prospectuses are available in the following languages: DE, EN, FR, IT, ES.

For further details, see page 2.

Important notice



Explosion hazard or humidity

Our balances are not suitable for rooms with a risk of explosion. Our models are also not suitable for rooms with a high level of air humidity (condensing). Please observe the applicable electrical regulations.

Earth's gravitational force

Electronic balances are subject to location regulations due to the earth's gravitational force. If location of use is changed, reverification and recalibration of the electronic balance is needed.

See the glossary, page 223 ► **Adjusting**