



HELIOS · PREISSER



METROLOGY CATALOGUE 2017/2018

In Germany at home – in demand worldwide

www.helios-preisser.de

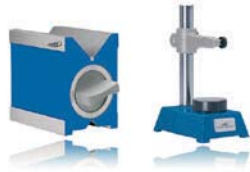

METROLOGY | 2017 / 2018

In Germany at home – in demand worldwide



LOCATION GERMANY

Certified
according to
DIN EN ISO
9001:2015



OUR HEADQUARTERS
in GAMMERTINGEN





For you, **we will go the LIMIT -**
and **BEYOND.**

Many years ago, we set our sights for Europe with a first-class selection. Today, we are represented in many countries with our products. These markets are operating with resounding success and continually provide customer-oriented support. Of course, we have not forgotten where we came from. In the German market, which is extremely important to us, we have always strived to live up to the expectations of our customers. In this way, we can continue to set trends with new innovations and finely segmented service. Whether user-friendly technical, visual, or haptic innovations – as a hands-on company, we remain a flexible partner that redefines service boundaries and takes on challenges related to measurement.

In this catalogue, you will find both established products and new innovations. For example, our callipers feature wireless data transmission – the results are directly transferred from the measuring device to your PC via the integrated wireless transmitter. Cable is a thing of the past. Now your results are quickly and directly transmitted to where you need them – without communication error.

By the way: If you need something or we can support your measurement needs in any way, please let us know. The HELIOS-PREISSER team is happy to be of service.

A handwritten signature in black ink, reading "Rainer Fahrenholz". The signature is fluid and cursive.

Rainer Fahrenholz
Managing Director



WE ARE AN APPROVED TRAINING COMPANY

Our trainees are an important part of our corporate structure, because we rely on qualified and motivated employees.

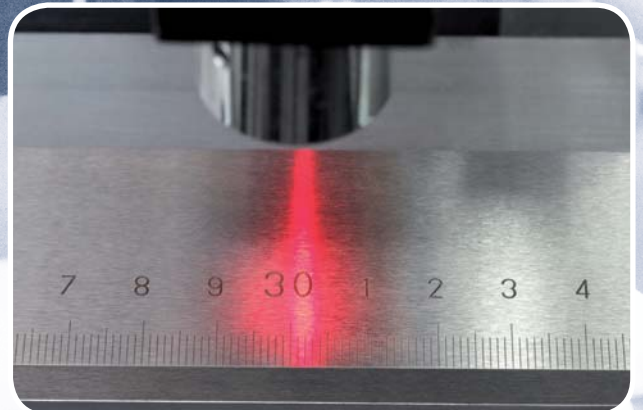



We continuously combine
PRECISION with **INNOVATION,**

generate new ideas, and refine and optimise established products – the only way we can continue to rank among the best. With modern equipment and the CAD/CAM system via the machining centre – including automatic pallet feed for non-stop 24-hour operation until the temperature-controlled environment – we manufacture precision measurement technology. One number highlights how important attention to detail is. By establishing a modern laser scaling system with built-in video system, we achieve an accuracy of < 0.0025 mm at a length of 1000 mm. We set these standards in all areas of our production and offer our customers a quality that is almost unparalleled in Europe and internationally.

For us, customer orientation gives us the drive to aim for even greater heights. Our well-trained employees play an important role; their unique expertise is the basis of our success. To maintain this high standard, we regularly train young individuals. After graduation, we take them on and continue to promote their professional development. By doing so, we ensure that we will continue to be an excellent partner for our customers – with certified production on the Swabian Alb as well as a highly skilled and flexible team.

A handwritten signature in black ink that reads "Siegfried Lorch".

Siegfried Lorch
Managing Director



NEW

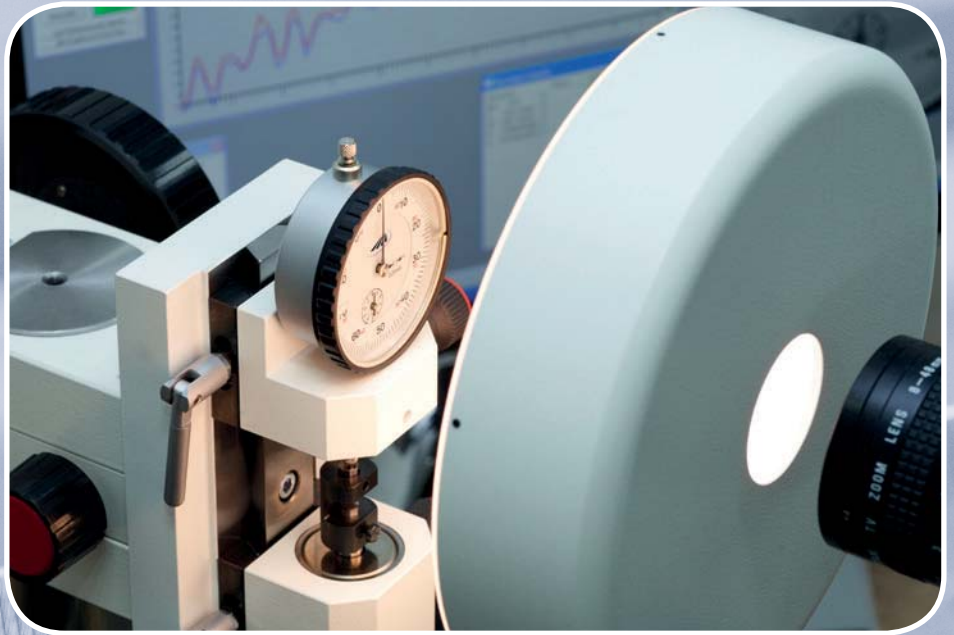



SERVICE THAT LEAVES NO QUESTIONS UNASKED

Flexible and fast – that's what matters, especially when you need us. For example, if your measuring equipment is defective. Our new repair-exchange system therefore offers impressive advantages for many products:

- Instead of time-consuming repairs, we offer you a refurbished unit with the required precision that is ready to use.
- This considerably minimises your downtime.
- There are no unexpected repair costs and
- You receive a six-month warranty on our replacement devices.

Because we always like to offer our customers more, we are here for you with our proven service:

- Professional after-sales service for your measuring equipment.
- Technical advice and support.
- Trade-oriented product training.

For more than 75 years we have been demonstrating our expertise on a daily basis.

Let yourself be inspired by a commercially attractive combination, the fine quality, absolute precision, and customised service combined in a single phrase: HELIOS-PREISSER.



OUR PARTICULAR STRENGTH:

Precision measuring instruments in the highest quality. Developed and produced by us for your specific requirements and areas of application.

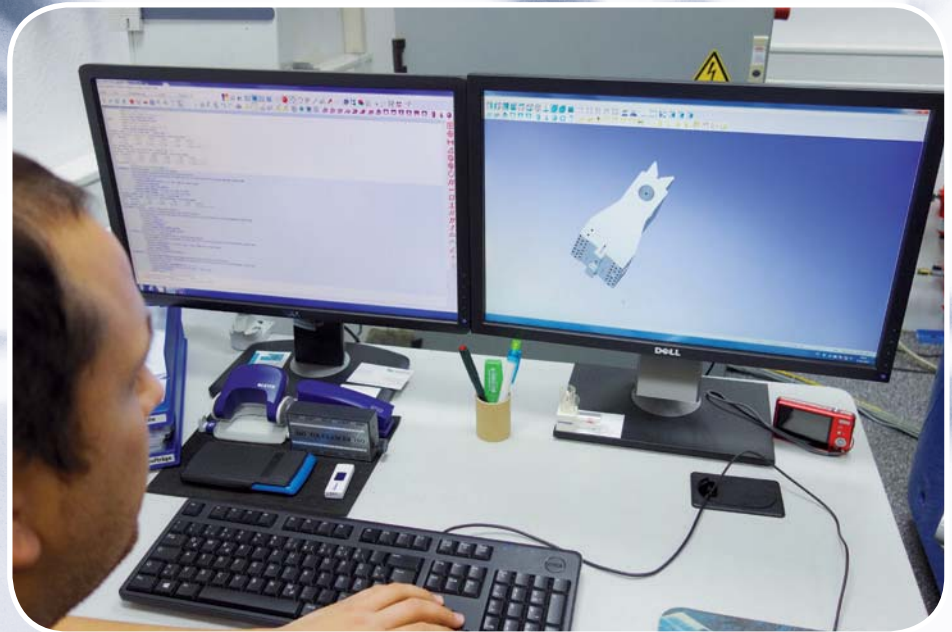

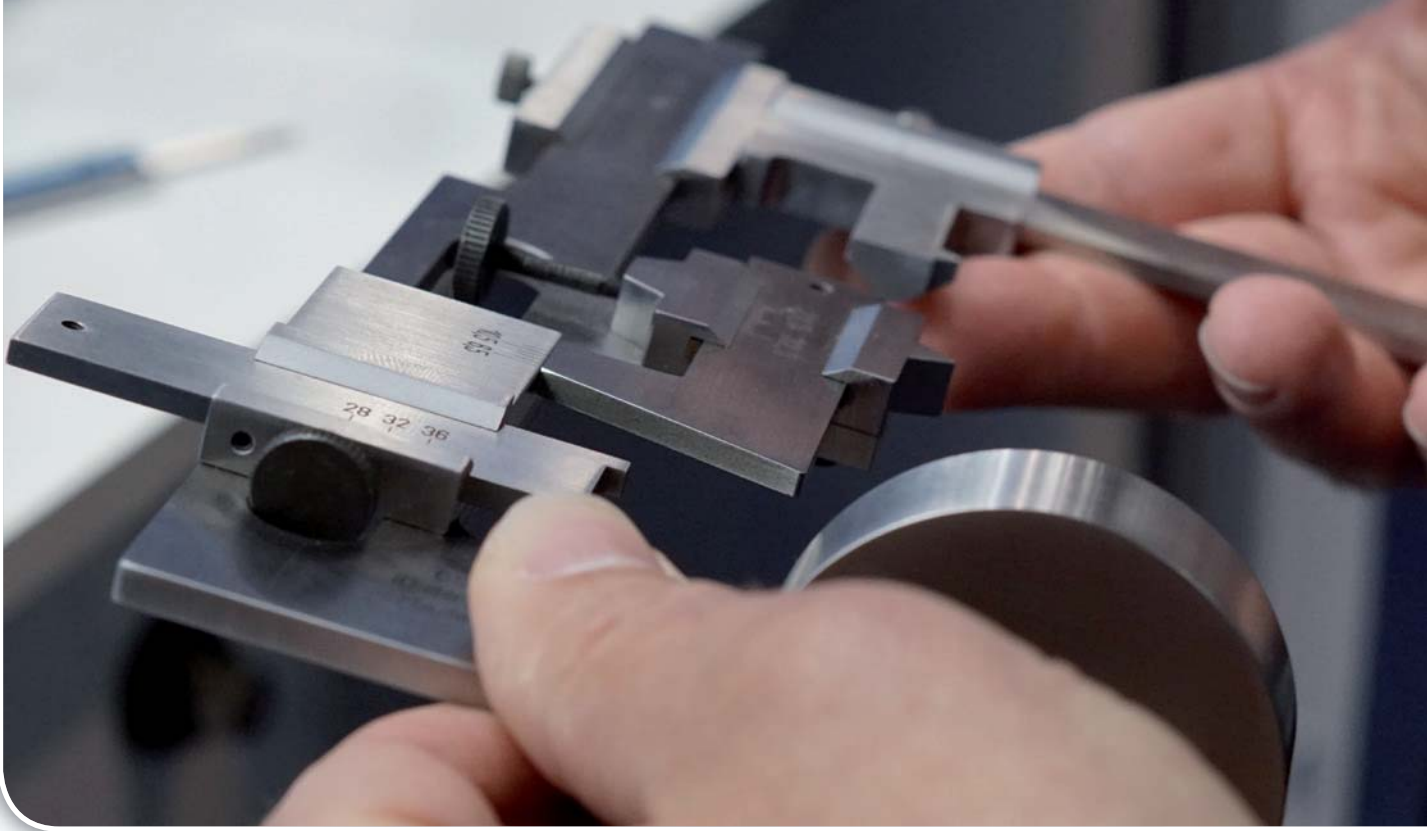

CUSTOM MADE PRODUCTS ACCORDING TO CUSTOMER SPECIFICATIONS

This statement is as true for our overall product range as it is for individual items

such as digital calipers, gauges and external micrometers. Whether universal or special, our options range from small, handy vernier digital pocket calipers to versatile, highly accurate comparators.

What sets all of our products apart, regardless of variant, is their utmost precision and a very special strength:







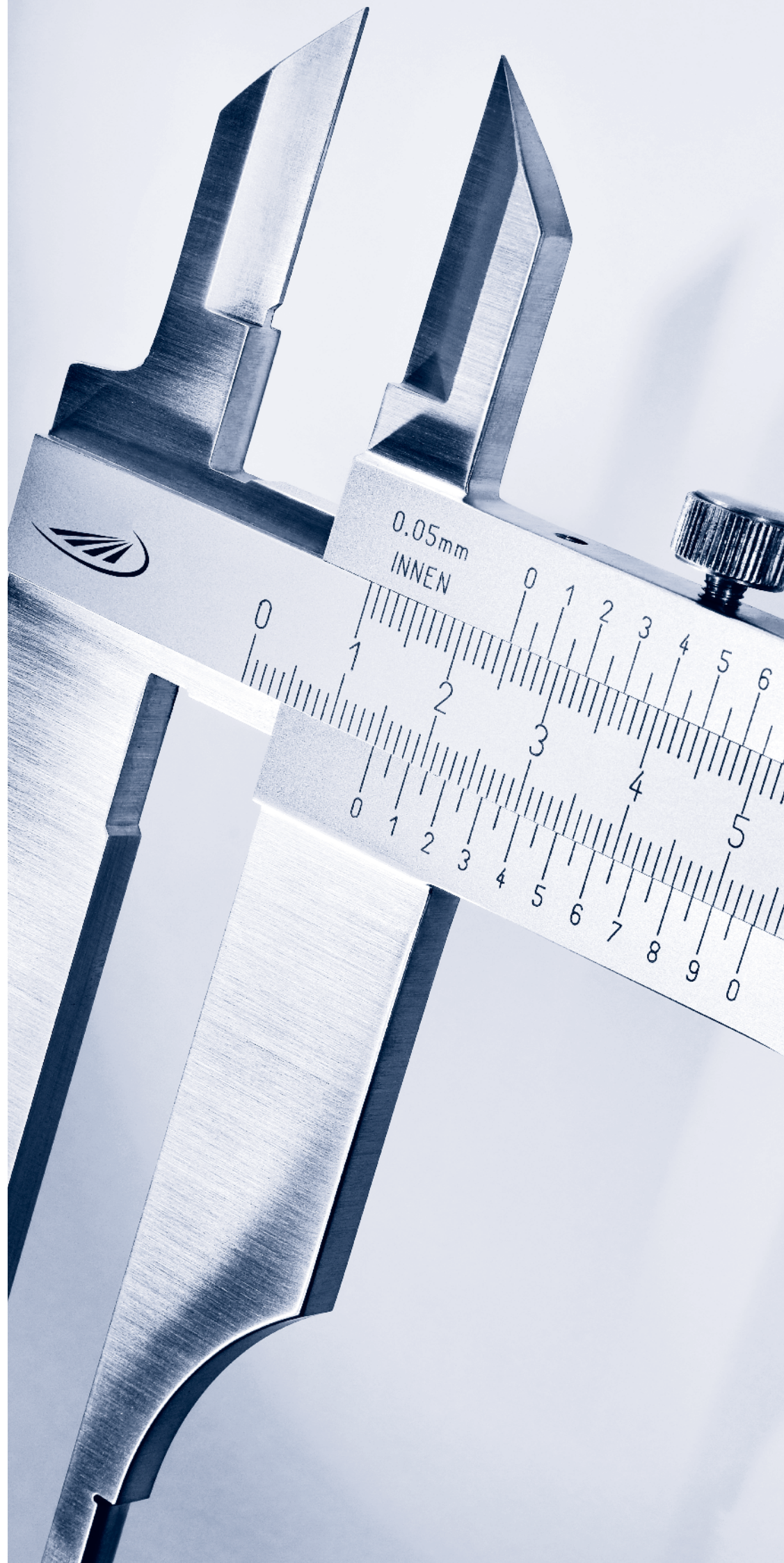

customisation according to your wishes.

We offer the same quality in all other areas of portable measurement technology,

including advice from experienced staff, problem solving, training, calibration... There's one thing you can completely rely on: anything displaying the HELIOS-PREISSER logo meets the highest standards. Guaranteed!



CONTENTS CATALOGUE

1	Calipers	
2	Micrometers	
3	Dial gauges and Indicating instruments	
4	Marking instruments	
5	Squares, Protractors, Bevel protractors	
6	Inspection equipment, Standards, Rules	
7	Data transmission	
8	Calibration service, Order number index, Keyword index	



SAMPLES CALIPER

NEW

Cross points for internal measurement
Locking screw
Slide
Beam
Rectangular depth gauge
Line scales
Vernier scales
Moveable measuring jaw
Fixed measuring jaw

SOFT-SLIDE
smooth running due to twice lapped guide surface

Integrated data transmission (Integrated Wireless)

Easy to read LCD display

Round depth gauge

Intuitive menu guidance

QuickLock Function: Keylock saves the zero setting

QuickStart Electronic: Moving the slider starts your measurement

NEW

1326i
with integrated wireless

Possible application for **calipers**

External measurement

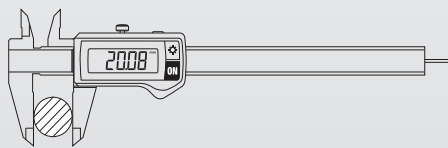

Internal measurement

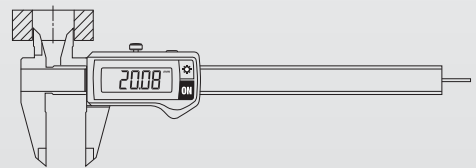

Depth measurement



Step (distance) measurement

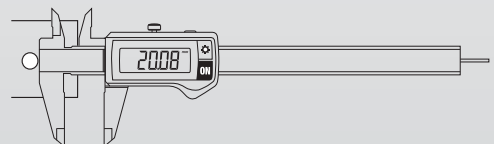

1. CHAPTER CALIPERS

14	Pocket vernier calipers
20	Pocket calipers / Tyre profile depth gauge
21	Pocket calipers with dial
22	Measuring tool sets
24	Digital pocket calipers
30	Digital pocket calipers for specific measuring tasks
36	Steel gauge block inspection set for calipers
37	Vernier workshop calipers
44	Workshop caliper with dial / Lightweight workshop calipers
45	Analogue caliper with cross points / gripper points
46	Digital workshop calipers
57	Contraction vernier calipers
59	Calipers for external locking grooves
60	Brake drum vernier calipers / Brake disc inspection gauges
61	Calipers for internal locking grooves
62	Calipers for 3/5 point measurement / for milling tool setting
64	Chamfer / Radius gauges
64	Gear tooth calipers
65	Vernier depth gauges
69	Digital depth gauges
77	Digital depth gauges with interchangeable inserts
80	Digital depth gauge for one-handed operation
82	Digital mounting scales
83	Wooden cases



0184 Pocket vernier calipers



DIN
862

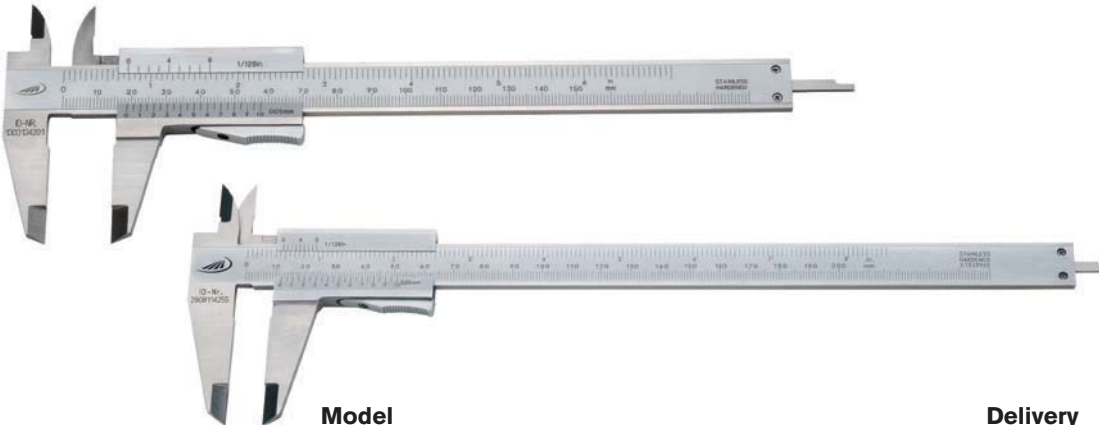

Model

- Stainless steel
- Reading parts have a satin chrome finish
- DIN 862
- Inside cross points
- Low-set master scale
- Four way measurement
- Includes thread table

Delivery

- Imitation leather case

✂	📏	Measuring range		Jaw length		Reading		Error limit	Depth gauge	Order no.	List price EUR
		mm	inch	mm	inch	mm	inch				
With thumb clamp											
		0 - 150	0 - 6	40	1.6	0.05	1/128	0.05	rect.	0184 501	25.00
		0 - 200	0 - 8	40	1.6	0.05	1/128	0.05	rect.	0184 505	33.00
		0 - 300	0 - 12	50	2.0	0.05	1/128	0.05	none	0184 508	49.00

0185 Pocket vernier calipers



DIN
862

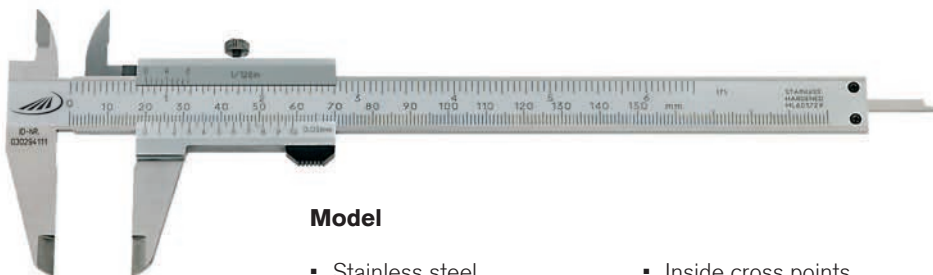

Model

- Stainless steel
- Reading parts have a satin chrome finish
- DIN 862
- Inside cross points
- Low-set master scale
- Four way measurement
- Includes thread table

Delivery

- Imitation leather case

✂	📏	Measuring range		Jaw length		Reading		Error limit	Depth gauge	Order no.	List price EUR
		mm	inch	mm	inch	mm	inch				
With locking screw											
		0 - 100	0 - 4	30	1.2	0.05		0.05	rect.	0185 500	19.50
		0 - 150	0 - 6	40	1.6	0.05	1/128	0.05	rect.	0185 501	25.00
		0 - 200	0 - 8	50	2.0	0.05	1/128	0.05	rect.	0185 505	33.00
		0 - 300	0 - 12	60	2.4	0.05	1/128	0.05	none	0185 508	49.00



HELIOS · PREISSER

0188 / 0189 Pocket vernier calipers



DIN 862

1



Model

- Stainless steel
- Reading parts have a satin chrome finish
- DIN 862
- Inside cross points
- Low-set master scale
- Four way measurement
- Includes thread table

Delivery

- Imitation leather case

Icon	Measuring range		Jaw length		Reading		Error limit	Depth gauge	Order no.	List price
	mm	inch	mm	inch	mm	inch				
With thumb clamp	0 - 150	0 - 6	40	1.6	0.05	1/128	0.05	rect.	0188 501	22.00
With locking screw	0 - 150	0 - 6	40	1.6	0.05	1/128	0.05	rect.	0189 501	22.00

0194 / 0195 Pocket vernier calipers with round depth rod



DIN 862



Model

- Stainless steel
- Reading parts have a satin chrome finish
- DIN 862
- Inside cross points
- Low-set master scale
- Four way measurement
- Includes thread table

Delivery

- Imitation leather case

Icon	Measuring range		Jaw length		Reading		Error limit	Depth gauge	Order no.	List price
	mm	inch	mm	inch	mm	inch				
With thumb clamp	0 - 150	0 - 6	40	1.6	0.05	1/128	0.05	round 1.6	0194 501	26.00
With locking screw	0 - 150	0 - 6	40	1.6	0.05	1/128	0.05	round 1.6	0195 501	26.00



0196 Pocket vernier calipers with reading 0.02 mm



Model

- Stainless steel
- Reading parts have a satin chrome finish
- DIN 862
- Inside cross points
- Low-set master scale
- Four way measurement
- Includes thread table

Delivery

- Imitation leather case

**DIN
862**

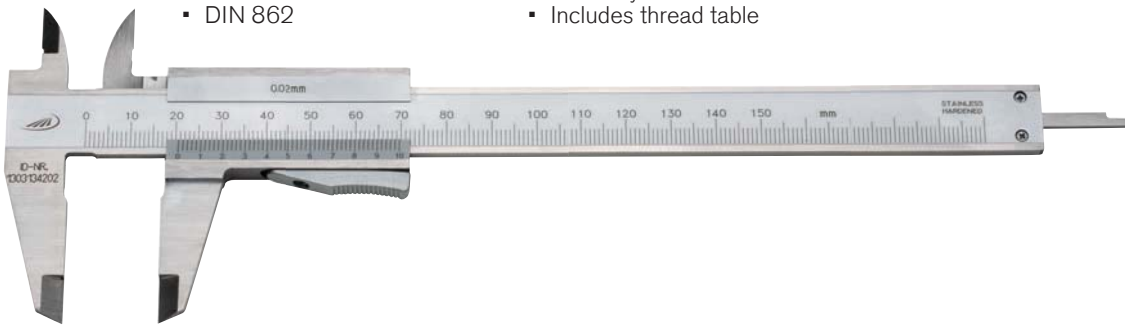

	Measuring range		Jaw length		Reading	Error limit	Depth gauge	Order no.	List price
	mm	inch	mm	inch					
	With thumb clamp								
	0 - 150	0 - 6	40	1.6	0.02	0.03	rect.	019650 105	24.10

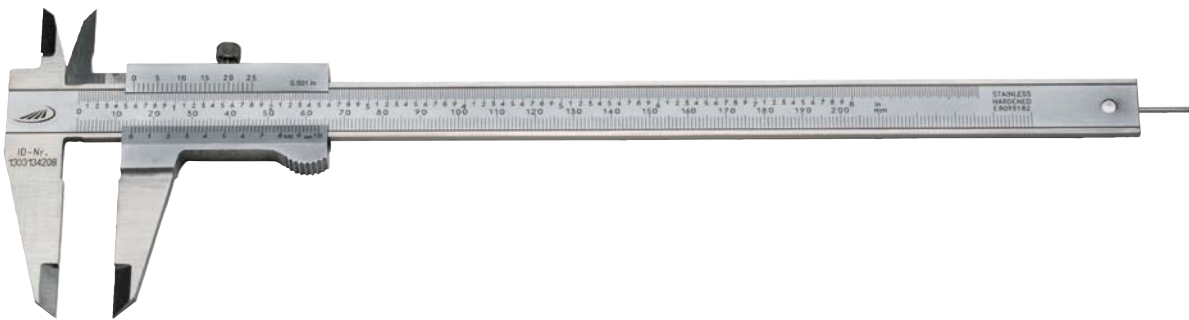

	Measuring range		Jaw length		Reading	Error limit	Depth gauge	Order no.	List price
	mm	inch	mm	inch					
	With locking screw								
	0 - 200	0 - 8	50	2.0	0.02	0.03	round 1.6	019650 516	34.50



	Measuring range		Jaw length		Reading	Error limit	Depth gauge	Order no.	List price
	mm	inch	mm	inch					
	With locking screw								
	0 - 150	0 - 6	40	1.6	0.02	0.03	rect.	019650 116	24.10



0197 Pocket vernier calipers SOFT - SLIDE

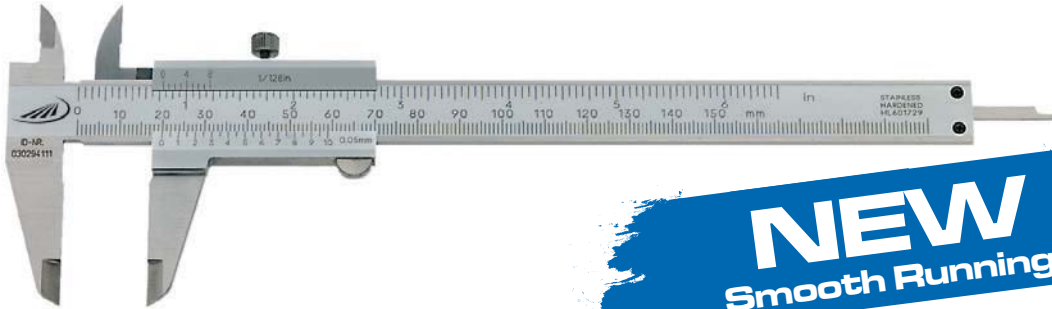

DIN 862

1

NEW
Smooth Running

Model

- Smooth running due to twice lapped guide surface
- Stainless steel
- Reading parts have a satin chrome finish

Delivery

- DIN 862
- Inside cross points
- Low-set master scale
- Four way measurement
- Includes thread table
- Imitation leather case

⌕	%	Measuring range		Jaw length		Reading		Error limit	Depth gauge	Order no.	List price EUR
		mm	inch	mm	inch	mm	inch	mm	mm		
		0 - 150	0 - 6	40	1.6	0.05		0.05	rect.	0197 501	32.00
		0 - 200	0 - 8	50	2.0	0.05		0.05	rect.	0197 505	75.00
		0 - 300	0 - 12	60	2.4	0.05		0.05	none	0197 508	149.00

0198 / 0199 Pocket vernier calipers with parallax-free reading

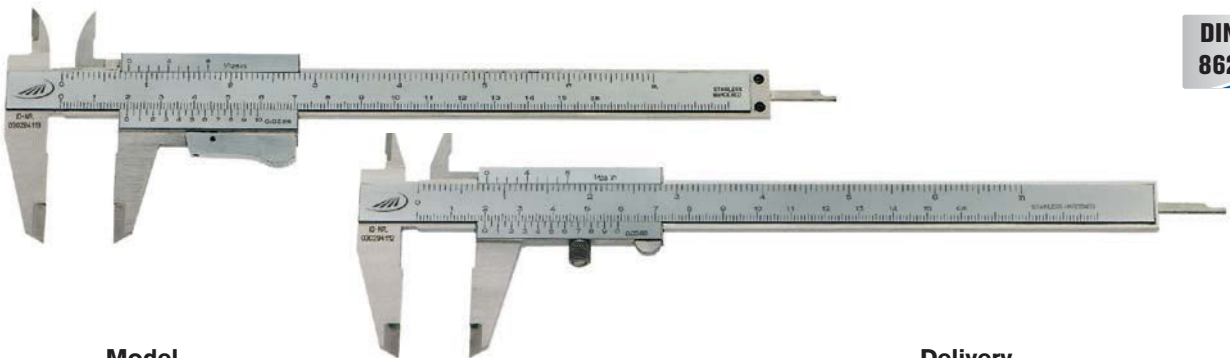

DIN 862

Model

- **Parallax-free reading**
- Stainless steel
- Reading parts have a satin chrome finish
- DIN 862

Delivery

- Inside cross points
- Four way measurement
- Includes thread table
- Imitation leather case

⌕	%	Measuring range		Jaw length		Reading		Error limit	Depth gauge	Order no.	List price EUR
		mm	inch	mm	inch	mm	inch	mm	mm		
With thumb clamp											
		0 - 150	0 - 6	40	1.6	0.05	1/128	0.05	rect.	0198 501	29.50
With locking screw											
		0 - 150	0 - 6	40	1.6	0.05	1/128	0.05	rect.	0199 501	29.50



0190 Pocket vernier caliper DUO-FIX



DIN
862

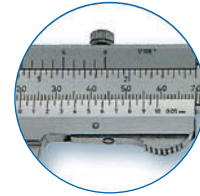
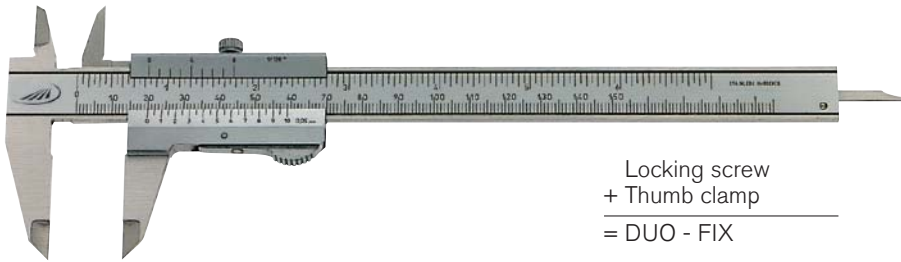

Locking screw
+ Thumb clamp
= DUO - FIX

Model

- Stainless steel
- Reading parts have a satin chrome finish
- DIN 862
- Thumb clamp **and** locking screw
- Inside cross points
- Low-set master scale
- Four way measurement
- Includes thread table

Delivery

- Imitation leather case

✂	📏	Measuring range		Jaw length		Reading		Error limit	Depth gauge	Order no.	List price
		mm	inch	mm	inch	mm	inch	mm	mm		EUR
		0 - 150	0 - 6	40	1.6	0.05	1/128	0.05	rect.	0190 501	26.00

0203 Precision pocket vernier caliper PRISMA



DIN
862

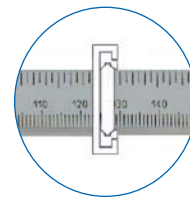

Model

- **Parallax-free reading**
- **Double prisma guide with excellent sliding characteristics**
- Stainless steel
- Reading parts have a satin chrome finish
- DIN 862
- Low-set locking screw
- Inside cross points
- Four way measurement
- Includes thread table

Delivery

- Imitation leather case

✂	📏	Measuring range		Jaw length		Reading		Error limit	Depth gauge	Order no.	List price
		mm	inch	mm	inch	mm	inch	mm	mm		EUR
		0 - 150	0 - 6	40	1.6	0.05	1/128	0.05	rect.	0203 501	49.50



HELIOS • PREISSER

0182 Pocket vernier caliper for lefthanded

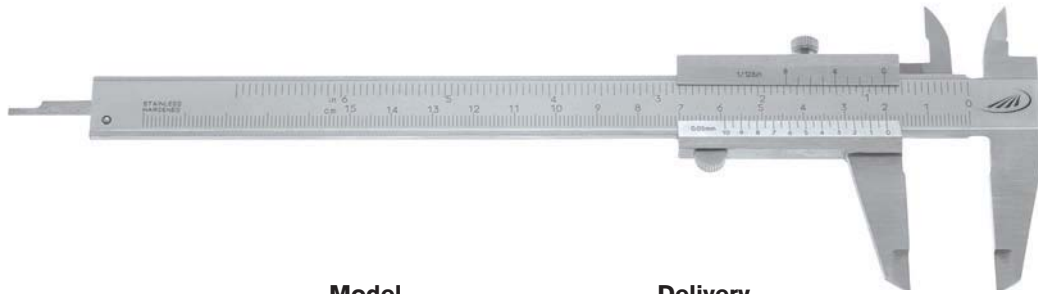

1

Model

- Stainless steel
- Reading parts have a satin chrome finish
- Locking screw
- Factory standard

Delivery

- Imitation leather case

☒ ☒	Measuring range		Jaw length		Reading		Error limit	Depth gauge	Order no.	List price EUR
	mm	inch	mm	inch	mm	inch	mm	mm		
With locking screw										
	0 - 150	0 - 6	40	1.6	0.05	1/128	0.05	rect.	0182 501	33.20

0261 Shaft distance caliper

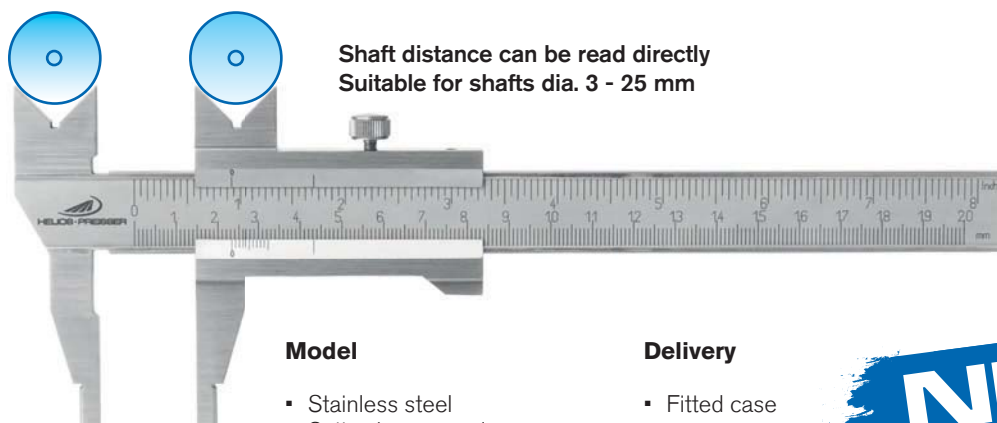

Model

- Stainless steel
- Satin chrome scale
- Factory standard
- Main intervals are located deeper
- Stepped jaws for inside measurement: 10 mm

Delivery

- Fitted case

NEW

☒ ☒	Measuring range		Jaw length	Reading	Order no.	List price EUR
	mm	inch	mm	mm		
	0 - 150	0 - 6	40	0.05	0261 516	215.00



0180 Pocket caliper



Model

- Made from hard brass
- Factory standard

Delivery

- Cardboard box

	Measuring range		Jaw length		Reading		Order no.	List price EUR
	mm	inch	mm	inch	mm	inch		
	0 - 100	0 - 6	25	1.0	0.1	1/16	0180 320	6.80

0180 Pocket caliper



Model

- Made from hard brass
- Stepped jaw 5 mm for internal measurement
- Factory standard

Delivery

- Cardboard box

	Measuring range		Jaw length		Reading		Order no.	List price EUR
	mm	inch	mm	inch	mm	inch		
	0 - 100	0 - 6	25	1.0	0.1	1/16	0180 330	6.80

0180 Tyre profile depth gauge



Model

- Made from hard brass
- Factory standard

Delivery

- Cardboard box

	Measuring range		Jaw length		Reading		Order no.	List price EUR
	mm	inch	mm	inch	mm	inch		
	0 - 30	0 - 1.18	30	1.2	0.1	1/16	0180 310	4.20



0216 Dial calipers with long inside cross points



1

Model

- Stainless steel
- Satin chrome scale
- Factory standard
- Locking screw
- Inside cross points
- One pointer revolution = 10 mm
- Adjustable dial face

Delivery

- Fitted case

✕	Measuring range		Jaw length		Reading		Error limit	Depth gauge	Order no.	List price
	mm	inch	mm	inch	mm	inch				
	0 - 150	0 - 6	40	1.6	0.05	1/128	0.05	rect.	0216 521	EUR 352.00

0217 / 0218 Dial calipers



DIN 862

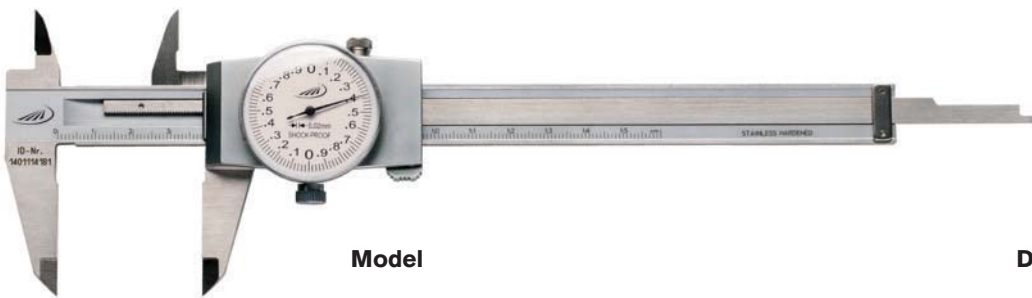

Model

- Stainless steel
- Satin chrome scale
- DIN 862
- Locking screw
- Inside cross points
- One pointer revolution with 0217 = 2 mm
- One pointer revolution with 0218 = 1 mm
- Four way measurement

Delivery

- Fitted case

✕	¼	Measuring range		Jaw length		Reading	Error limit	Depth gauge	Order no.	List price
		mm	inch	mm	inch					
▪		0 - 150	0 - 6	40	1.6	0.02	0.03	rect.	0217 501	EUR 65.00
▪		0 - 200	0 - 8	40	1.6	0.02	0.03	rect.	0217 502	EUR 131.00
▪		0 - 150	0 - 6	40	1.6	0.01	0.03	rect.	0218 501	EUR 87.00



0212 Quality measuring tool set, 8 piece



**INCLUDING
ONE POCKET CALIPER
OF YOUR CHOICE**



Content

- Pocket calipers in 5 different types of choice
- External micrometer with carbide measuring faces, measuring range 0-25 mm, reading 0.01 mm
- Flexible steel rule, stainless steel, measuring range 200 mm, graduation mm / mm, 13 x 0.5 mm
- Knife square, hardened, DIN 875/00, 100 x 70 mm, with non-glare knife edge
- Knife edge, hardened and ground, DIN 874/00, length 100 mm
- Scriber, carbide tipped, hexagonal handle made of one piece, with pocket clip, length 180 mm
- Radius gauge, special steel, 17 sheets, concave and convex, with locking nut, measuring range 1.0 – 7.0 mm
- Screw pitch gauge, combined metric ISO- and Whitworth thread, 48 blades, increments 0.4 – 7.0 / 4 – 62

▪ Shipment

- Wooden case

Marked *	Measuring range	Reading		Depth gauge	Order no.	List price
		mm	inch			
	Set with pocket caliper DUO - FIX (0190 501)					
	0 - 150	0.05	1/128	rect.	0212 520	128.00
	Set with DIGI-MET® Pocket caliper (1320 416 / 417)					
	0 - 150	0.01	.0005	round 1.5	0212 522	187.00
	0 - 150	0.01	.0005	rect.	0212 524	187.00
	Set with DIGI-MET® Pocket caliper IP67 (1326 416 / 417)					
	0 - 150	0.01	.0005	round 1.5	0212 526	213.00
	0 - 150	0.01	.0005	rect.	0212 528	213.00



DIGI-MET® QuickStart Electronic



QuickStart-Electronic with the QuickLock-Function for only one zero setting

All digital calipers with the QuickStart-Electronic also have the **QuickLock** Function. Only set the zero position once, zero position remains stored for all further measurements. When the **QuickLock** Function is activated a lock symbol appears in the display, this ensures that the zero position is protected against any operating error caused by accidental usage of the operating keys (keys are locked). The caliper is immediately ready for measurement; once the caliper is switched ON or the slide is moved, the display is automatically activated.

The need to reset to zero as with a conventional caliper once it is switched on is obsolete.

1

Conventional

- ① Switch ON
- ② Close the measuring jaws
- ③ Set to zero
- ④ Result of measurement

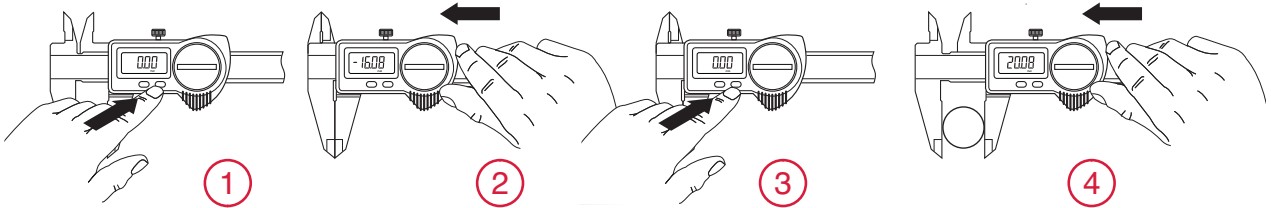

QuickStart Electronic



Press the ON key or move the slide

DIGI-MET® QuickLock-Function



- 1. Set to zero
- 2. Activate the QuickLock Function

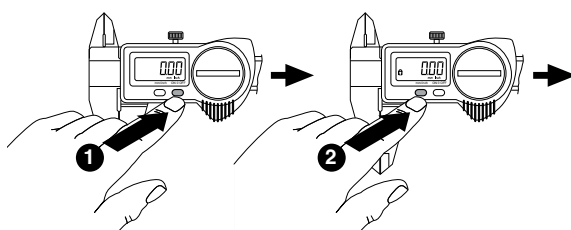

Advantages of the QuickLock Function

- The caliper is immediately ready for measurement
- Lock symbol appears in the display. This ensures that the zero position is protected against any operating error caused by accidental usage of the operating keys (keys are locked)



1326i DIGI-MET® Pocket calipers IP67 with integrated wireless



NOVELTY
Data transmission without cable
or radio module

**integrated
IW wireless**



132641 660

Model

- Measuring system is insensitive to fluids and cooling agents
- Protection class IP67
- Stainless steel
- LCD display 11 mm
- DIN 862
- Housing and operating keys have an excellent chemical resistance

- Locking screw
- Inside cross points
- Four way measurements

Functions

- ON / OFF
- Quick-Start**
- Quick-Lock** (key lock)
- Set to zero at any point
- mm / inch switching
- PRESET-Function (setting a numerical value)
- Integrated Wireless

Delivery

- Plastic case

Marked	Measuring range		Jaw length		Reading		Error limit	Depth gauge	Order no.	List price EUR
	mm	inch	mm	inch	mm	inch				
▪	0 - 150	0 - 6	40	1.6	0.01	.0005	0.03	round 1.5	132641 660	218.00
▪	0 - 150	0 - 6	40	1.6	0.01	.0005	0.03	rect.	132641 760	218.00
▪	0 - 200	0 - 8	50	2.0	0.01	.0005	0.03	rect.	132641 860	279.00
▪	0 - 300	0 - 12	65	2.5	0.01	.0005	0.03	none	132642 260	337.00



1998780

Accessories

Battery, 3V-Lithium, CR 2032
i-Stick USB-receiver for Integrated Wireless

Order no.

0220 704
1998 780

List price EUR

3.70
97.00

Integrated Wireless is intended to be sold in the EU only



HELIOS · PREISSER

1320 DIGI-MET® Pocket calipers

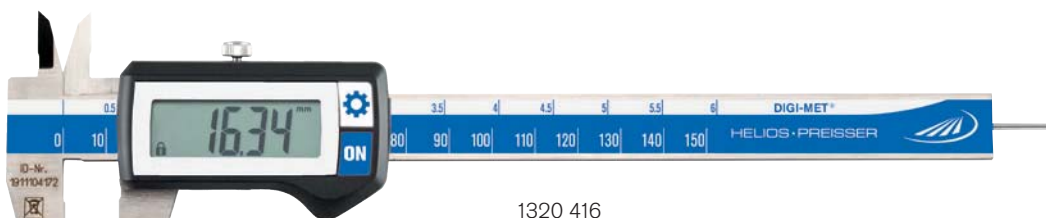

1320 416



1320 517



Model

- Inductive measuring system, resistant to damp and sweat
- Stainless steel
- LCD display 11 mm without data output, 7.5 mm with data output
- DIN 862
- Locking screw
- Inside cross points

- Four way measurement with measuring ranges 150 and 200 mm
- Three way measurement with measuring range 300 mm

Functions

- ON / OFF
- **Quick-Start**
- **Quick-Lock** (key lock)
- Set to zero at any point
- mm / inch switching
- **PRESET-Function** (setting a numerical value)

Delivery

- Plastic case

Icon	Measuring range		Jaw length		Reading		Error limit	Depth gauge	Order no.	List price EUR
	mm	inch	mm	inch	mm	inch	mm	mm		
Without data output										
▪	0 - 150	0 - 6	40	1.6	0.01	.0005	0.03	round 1.5	1320 416	109.00
▪	0 - 150	0 - 6	40	1.6	0.01	.0005	0.03	rect.	1320 417	109.00
With DATA VARIABLE										
▪	0 - 150	0 - 6	40	1.6	0.01	.0005	0.03	round 1.5	1320 516	142.00
▪	0 - 150	0 - 6	40	1.6	0.01	.0005	0.03	rect.	1320 517	142.00
▪	0 - 200	0 - 8	50	2.0	0.01	.0005	0.03	rect.	1320 519	179.00
▪	0 - 300	0 - 12	65	2.5	0.01	.0005	0.03	none	1320 522	230.00
With DATA VARIABLE, with extra long cross tips (40 mm)										
▪	0 - 150	0 - 6	40	1.6	0.01	.0005	0.03	round 1.5	1320 518	384.00



1998720

1998501

1997501

Accessories

	Order no.	List price EUR
Battery, 3V-Lithium, CR 2032	0220 704	3.70
Data cable DATA VARIABLE to digimatic	1998 501	61.00
Data cable DATA VARIABLE to RS232	1997 501	48.00
Data cable DATA VARIABLE to USB	1998 720	69.00



1326 DIGI-MET® Pocket calipers IP67



DIN
862

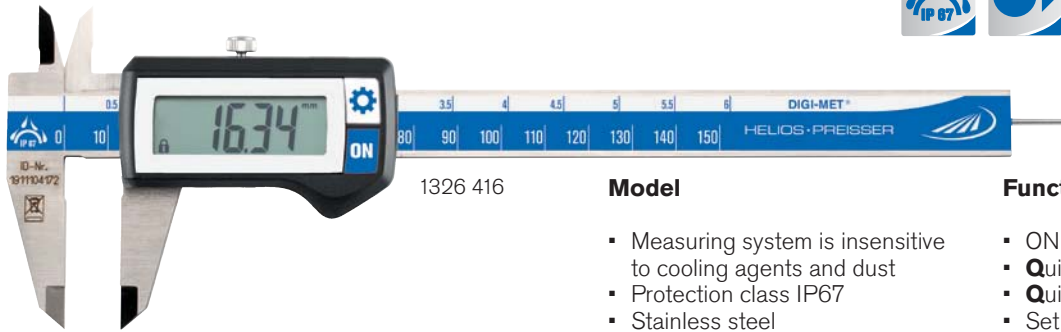

1326 416

Model

- Measuring system is insensitive to cooling agents and dust
- Protection class IP67
- Stainless steel
- LCD display 11 mm
- DIN 862
- Housing and operating keys have an excellent chemical resistance
- Locking screw
- Inside cross points
- Four way measurement with measuring ranges 150 and 200 mm
- Three way measurement with measuring range 300 mm

Functions

- ON / OFF
- Quick-Start
- Quick-Lock (key lock)
- Set to zero at any point
- mm / inch switching
- PRESET-Function (setting a numerical value)

Delivery

- Plastic case



Video
electronic

✕	📏	Measuring range		Jaw length		Reading		Error limit	Depth gauge	Order no.	List price EUR
		mm	inch	mm	inch	mm	inch				
▪		0 - 150	0 - 6	40	1.6	0.01	.0005	0.03	round 1.5	1326 416	158.00
▪		0 - 150	0 - 6	40	1.6	0.01	.0005	0.03	rect.	1326 417	158.00
▪		0 - 200	0 - 8	50	2.0	0.01	.0005	0.03	rect.	1326 418	219.00
▪		0 - 300	0 - 12	65	2.5	0.01	.0005	0.03	none	1326 422	277.00
With carbide-tipped measuring jaws											
▪		0 - 150	0 - 6	40	1.6	0.01	.0005	0.03	round 1.5	1326 914	329.00

Accessories

Battery, 3V-Lithium, CR 2032

Order no.

0220 704

List price

EUR

3.70

0220 Additional depth measuring base

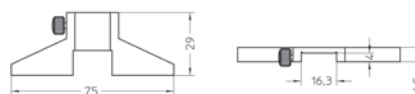

Model

- Stainless steel
- Bridge length: 75 mm
- Dimensions: 75 x 6.5 mm

✕	📏	Order no.	List price EUR
		0220 705	21.50



HELIOS · PREISSER

1326 DIGI-MET® Pocket calipers IP67 with data output

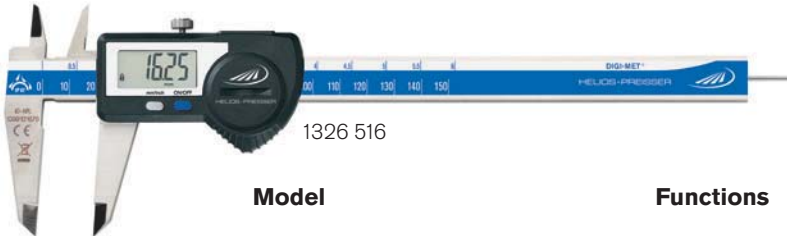

1326 516



Model

- Measuring system is insensitive to fluids and cooling agents
- Protection class IP67
- Stainless steel
- LCD display 7.5 mm
- DIN 862
- Locking screw
- Inside cross points
- Four way measurement

Functions

- ON / OFF
- Quick-Start**
- Quick-Lock** (key lock)
- Set to zero at any point
- mm / inch switching
- Variable data output RS 232 + Digimatic + USB

Delivery

- Plastic case

☒	Measuring range		Jaw length		Reading		Error limit	Depth gauge	Order no.	List price
	mm	inch	mm	inch	mm	inch	mm	mm		EUR
▪	0 - 150	0 - 6	40	1.6	0.01	.0005	0.03	round 1.5	1326 516	158.00
▪	0 - 150	0 - 6	40	1.6	0.01	.0005	0.03	rect.	1326 517	158.00
▪	0 - 200	0 - 8	50	2.0	0.01	.0005	0.03	rect.	1326 518	231.00



Accessories

	Order no.	List price
		EUR
Battery, 3V-Lithium, CR 2032	0220 704	3.70
Data cable DATA VARIABLE to RS232	1997 501	48.00
Data cable DATA VARIABLE to digimatic	1998 501	61.00
Data cable DATA VARIABLE to USB	1998 720	69.00

1322 DIGI-MET® Pocket caliper PRISMA



Model

- Double prisma guide with excellent sliding characteristics
- Protection class IP67
- Stainless steel
- DIN 862
- LCD display 7.5 mm
- Locking screw
- Inside cross points
- Four way measurement

Functions

- ON / OFF
- Set to zero at any point
- mm / inch switching
- Quick-Start**
- Quick-Lock** (key lock)
- Variable data output RS 232 + Digimatic + USB

Delivery

- Wooden case

☒	Measuring range		Jaw length		Reading		Error limit	Depth gauge	Order no.	List price
	mm	inch	mm	inch	mm	inch	mm	mm		EUR
▪	0 - 150	0 - 6	40	1.6	0.01	.0005	0.03	round 1.5	1322 516	203.00

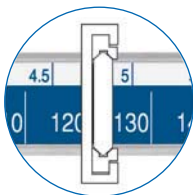



1998 / 0996 / 1997 Data cable



1998 720

1997 501

0996 701

1998 501

0996 705

Model

- Length 2 m
- For use with MarCom Professional software to transfer the measured results to PC, laptop or workstation

Model	Description	Order no.	List price EUR
0996 701	Cable Opto for RS232	0996 701	74.00
0996 705	Cable Opto for USB	0996 705	141.00
1997 501	Cable DataVariable for RS232	1997 501	48.00
1998 501	Cable DataVariable for Digimatic	1998 501	61.00
1998 720	Cable DataVariable for USB	1998 720	69.00

0145 Measuring tool set >>Extensions<<



Model

- Pairs of measuring inserts, disc dia. 6 / 10 / 12.5 mm
- Pair of measuring inserts with 60° cone, dia. 9 / 12.5 mm
- Pair of measuring inserts with cylindrical surfaces 1.5 mm
- Insert holder, right / left with thread M 2.5
- Allen wrench SW 1.2 mm

Delivery

- Wooden box

Model	Description	Order no.	List price EUR
0145 110	Measuring tool set, 14 pieces	0145 110	164.00



Measure distances between bore holes



Measure grooves



Measure distances



Measure distances between bore holes



Measure grooves



1326 Universal pocket caliper „Pocket Talent“

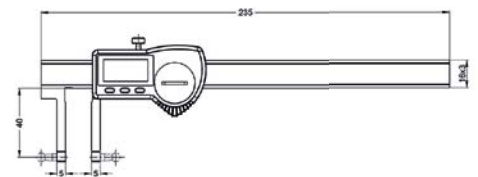

incl. setting standard

Model

- Stainless steel
- Protection class IP67
- Factory standard
- LCD display 7.5 mm
- Locking screw
- For internal and external measurements
- Individually adaptable on problematic tasks through measuring inserts with thread M 2.5

Functions

- ON / OFF
- **Quick-Start**
- **Quick-Lock** (key lock)
- Set to zero at any point
- mm / inch switching
- PRESET-Function (setting a numerical value)
- Variable data output RS 232 + Digimatic + USB

Delivery

- Wooden box
- Measuring inserts No. 0710161* and 0710177* Planar surface Ø 4.8 mm / Ball inserts Ø 5.0 mm
- Setting standard

Measuring range	Measuring range		Jaw length	Reading		Order no.	List price
	mm	inch		mm	mm		
0 - 150	0 - 6	40	0.01	.0005	1326 932	352.00	

The all-round talent which in conjunction with all common types of measuring inserts for indicators with a standard M 2.5 thread can be used for internal and external measurements. Therefore, the small universal caliper, "Pocket-Talent" offers you conduct numerous measurement applications.

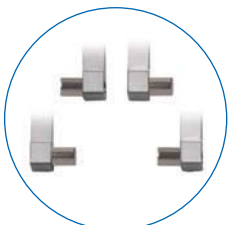

0710161*

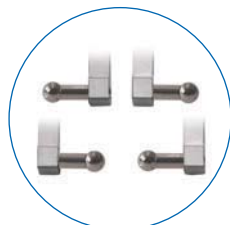

0710177*

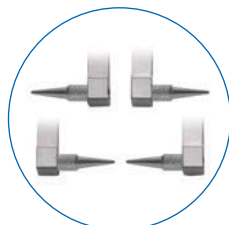

0710166

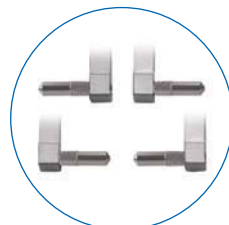

0710167

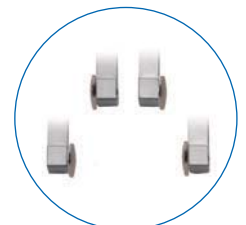

0710163



1998720



1998501



1997501

Accessories

	Order no.	List price
		EUR
Battery, 3V-Lithium, CR 2032	0220 704	3.70
Measuring inserts M 2.5	0710 161	3.50
Measuring inserts M 2.5	0710 163	5.20
Measuring inserts M 2.5	0710 166	4.70
Measuring inserts M 2.5	0710 167	3.30
Measuring inserts M 2.5	0710 177	6.50
Data cable DATA VARIABLE to RS232	1997 501	48.00
Data cable DATA VARIABLE to digimatic	1998 501	61.00
Data cable DATA VARIABLE to USB	1998 720	69.00



Product video



1326 DIGI-MET® Pocket calipers for specific measuring tasks

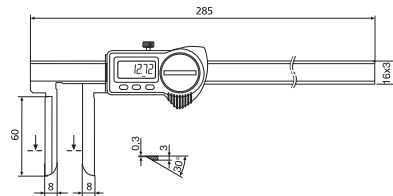
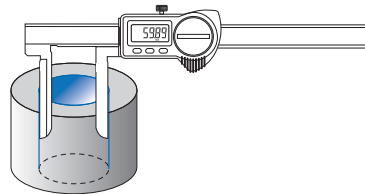
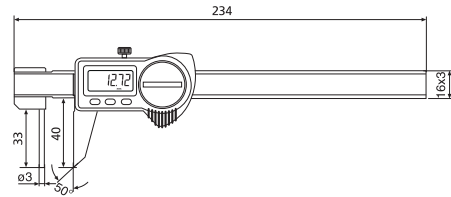
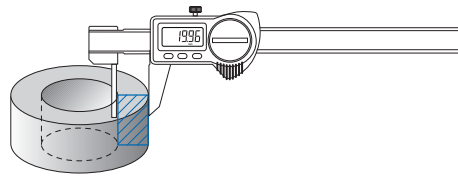
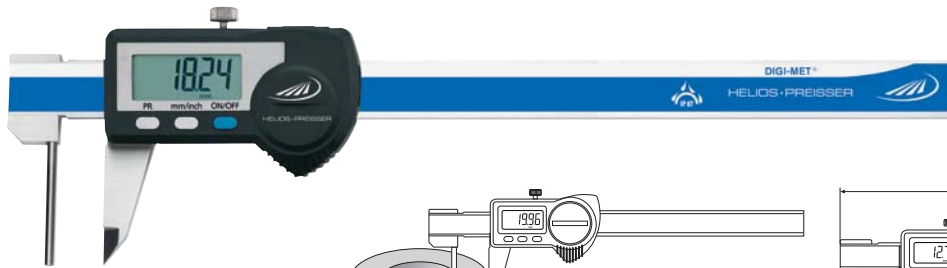

Model

- Protection class IP67
- Stainless steel
- LCD display 7.5 mm
- Factory standard
- Measuring system is insensitive to cooling agents and dust

- Housing and operating keys have an excellent chemical resistance
- Inside cross points
- Locking screw

Functions

- ON / OFF
- Quick-Start
- Quick-Lock (key lock)
- Set to zero at any point
- mm / inch switching
- PRESET-Function (setting a numerical value)
- Variable data output RS 232 + Digimatic + USB

Delivery

- Wooden case

⊗	%	Measuring range		Jaw length		Reading		Order no.	List price EUR
		mm	inch	mm	inch	mm	inch		
Wall thickness caliper									
		0 - 150	0 - 6	40	1.6	0.01	.0005	1326 918	483.00
With long cross jaws for inner measurements									
		10 - 200	0.4 - 8	60	2.4	0.01	.0005	1326 930	627.00

Accessories



1998720 1997501 1998501

Accessories	Order no.	List price EUR
Battery, 3V-Lithium, CR 2032	0220 704	3.70
Data cable DATA VARIABLE to RS232	1997 501	48.00
Data cable DATA VARIABLE to digimatic	1998 501	61.00
Data cable DATA VARIABLE to USB	1998 720	69.00



HELIOS · PREISSER

1326 DIGI-MET® Pocket calipers for specific measuring tasks

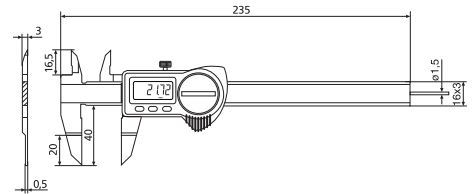
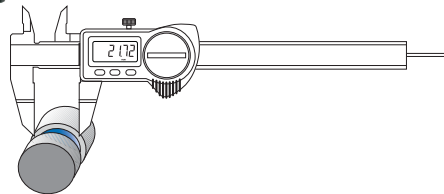
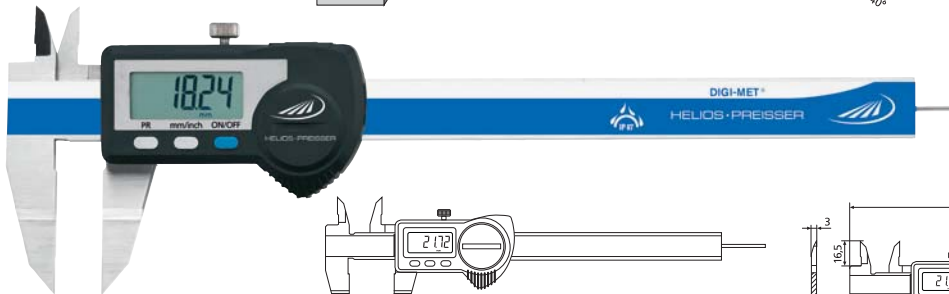
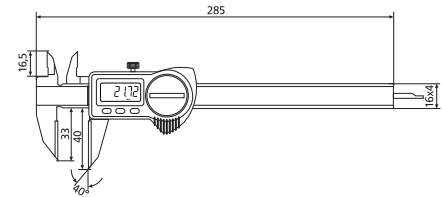
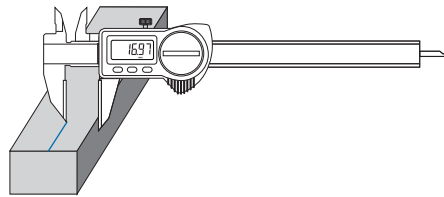
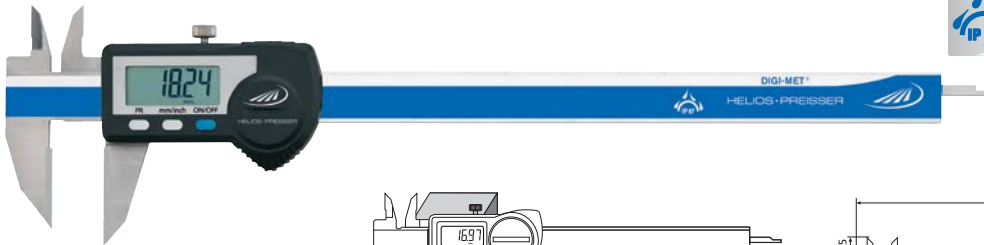

Model

- Protection class IP67
- Stainless steel
- LCD display 7,5 mm
- Factory standard
- Measuring system is insensitive to cooling agents and dust

- Housing and operating keys have an excellent chemical resistance
- Inside cross points
- Locking screw

Functions

- ON / OFF
- Quick-Start
- Quick-Lock (key lock)
- Set to zero at any point
- mm / inch switching
- PRESET-Function (setting a numerical value)
- Variable data output RS 232 + Digimatic + USB

Delivery

- Wooden case

»	¼	Measuring range		Jaw length		Reading		Depth gauge mm	Order no.	List price EUR
		mm	inch	mm	inch	mm	inch			
Scribing caliper with carbide-tipped outer measuring surfaces										
		0 - 200	0 - 8	33	1.3	0.01	.0005	rect.	1326 912	307.00
With flat measuring surfaces e.g. for outer recesses										
		0 - 150	0 - 6	40	1.6	0.01	.0005	round 1.5	1326 920	523.00



Accessories

	Order no.	List price EUR
Battery, 3V-Lithium, CR 2032	0220 704	3.70
Data cable DATA VARIABLE to RS232	1997 501	48.00
Data cable DATA VARIABLE to digimatic	1998 501	61.00
Data cable DATA VARIABLE to USB	1998 720	69.00



1326 DIGI-MET® Pocket calipers for specific measuring tasks

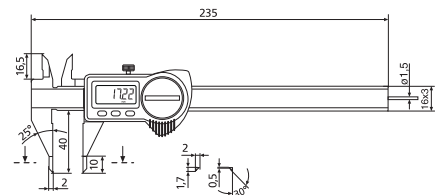
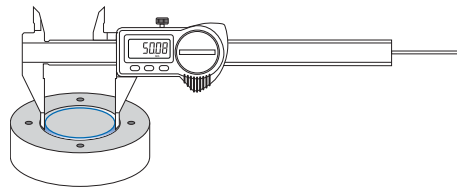
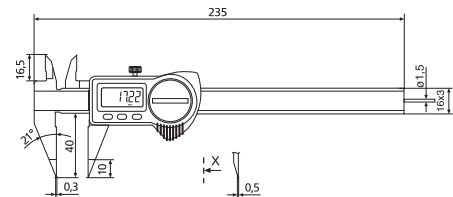
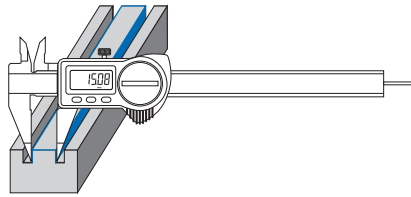

Model

- Protection class IP67
- Stainless steel
- LCD display 7.5 mm
- Factory standard
- Measuring system is insensitive to cooling agents and dust

- Housing and operating keys have an excellent chemical resistance
- Inside cross points
- Locking screw

Functions

- ON / OFF
- Quick-Start
- Quick-Lock (key lock)
- Set to zero at any point
- mm / inch switching
- PRESET-Function (setting a numerical value)
- Variable data output RS 232 + Digimatic + USB

Delivery

- Wooden case

Marked	Marked	Measuring range		Jaw length		Reading		Order no.	List price EUR
		mm	inch	mm	inch	mm	inch		
		With pointed jaws							
		0 - 150	0 - 6	40	1.6	0.01	.0005	1326 916	380.00
		With fine measuring tips							
		0 - 150	0 - 6	40	1.6	0.01	.0005	1326 922	429.00



Accessories

	Order no.	List price EUR
Battery, 3V-Lithium, CR 2032	0220 704	3.70
Data cable DATA VARIABLE to RS232	1997 501	48.00
Data cable DATA VARIABLE to digimatic	1998 501	61.00
Data cable DATA VARIABLE to USB	1998 720	69.00



HELIOS · PREISSER

1326 DIGI-MET® Pocket calipers for specific measuring tasks



1

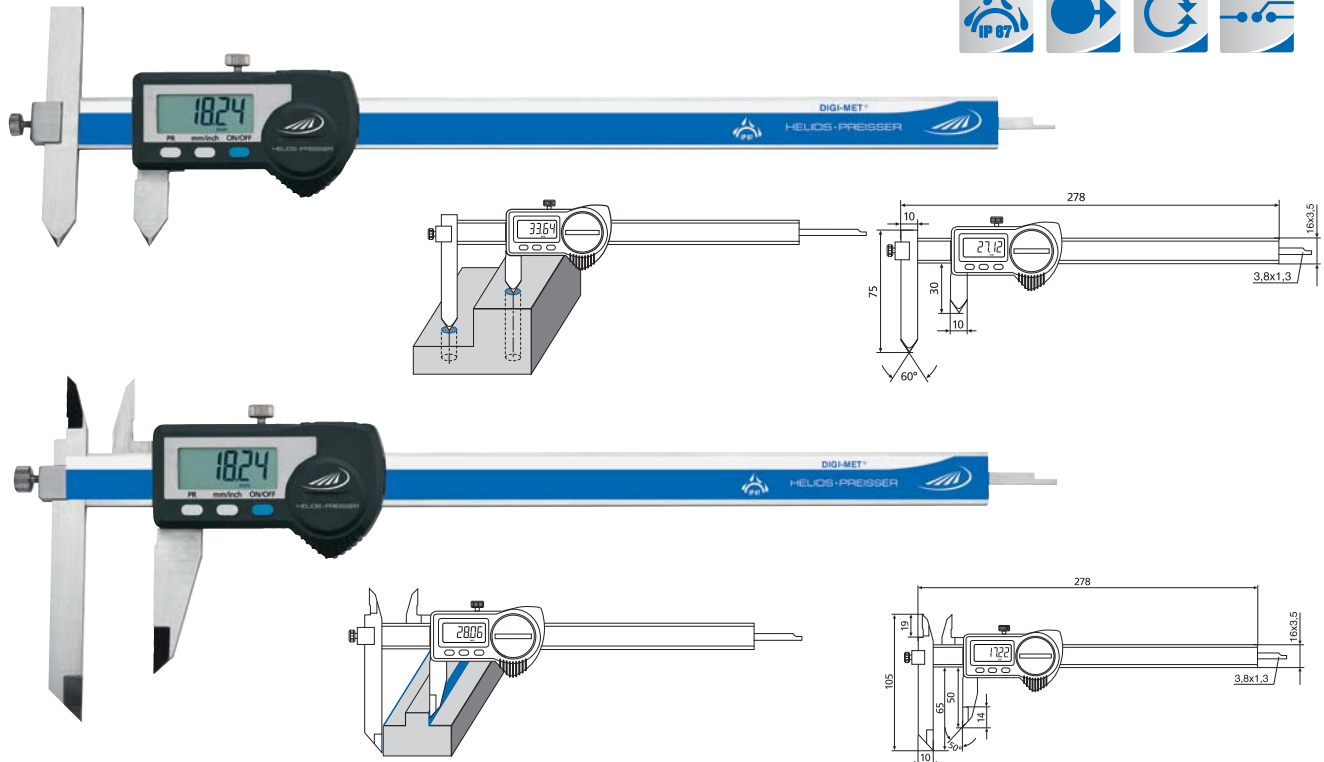

Model

- Protection class IP67
- Stainless steel
- LCD display 7.5 mm
- Factory standard
- Measuring system is insensitive to cooling agents and dust

- Housing and operating keys have an excellent chemical resistance
- Inside cross points
- Locking screw

Functions

- ON / OFF
- Quick-Start**
- Quick-Lock** (key lock)
- Set to zero at any point
- mm / inch switching
- PRESET-Function (setting a numerical value)
- Variable data output RS 232 + Digimatic + USB

Delivery

- Wooden case

» ¼	Measuring range		Jaw length		Reading		Order no.	List price EUR
	mm	inch	mm	inch	mm	inch		
Moving jaws for measuring the distance between bores								
	10 - 210	0.4 - 8.3	75	3.0	0.01	.0005	1326 924	425.00
Moving jaws + cross tips								
	0 - 200	0 - 8	65	2.5	0.01	.0005	1326 928	457.00



Accessories

	Order no.	List price EUR
Battery, 3V-Lithium, CR 2032	0220 704	3.70
Data cable DATA VARIABLE to RS232	1997 501	48.00
Data cable DATA VARIABLE to digimatic	1998 501	61.00
Data cable DATA VARIABLE to USB	1998 720	69.00



1326 DIGI-MET® Pocket calipers for specific measuring tasks

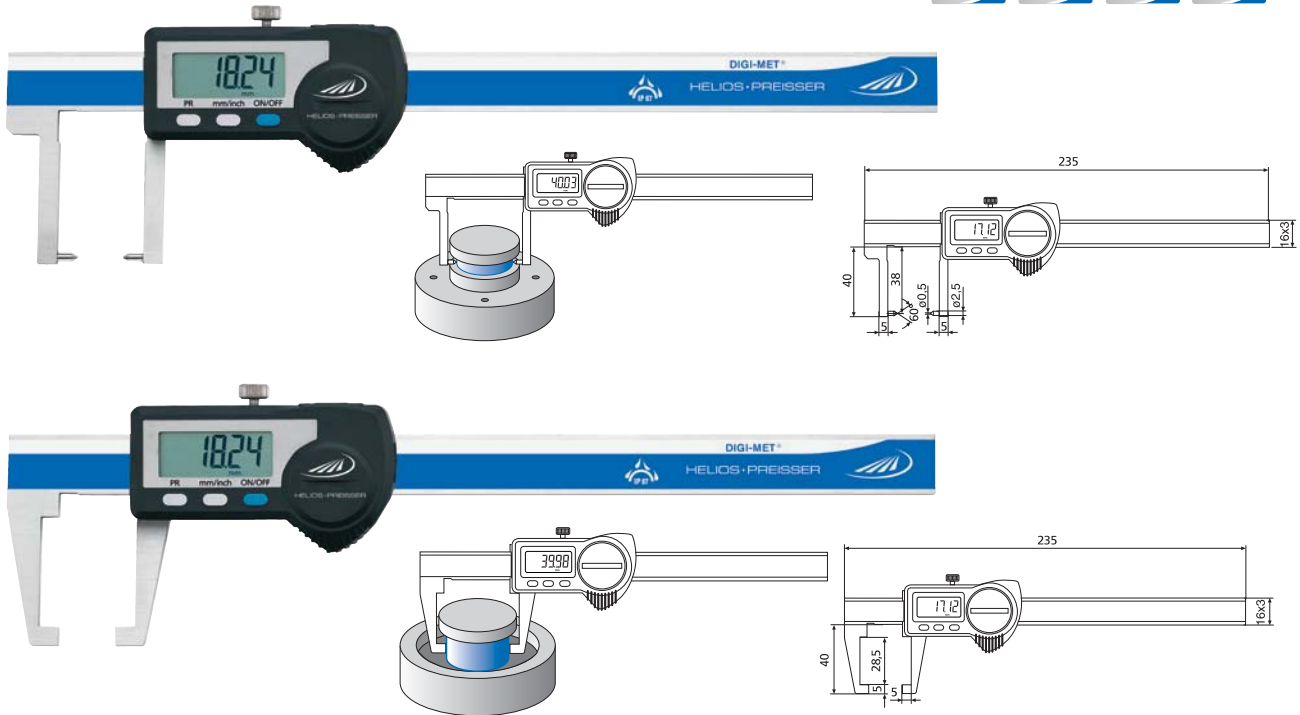

Model

- Protection class IP67
- Stainless steel
- LCD display 7.5 mm
- Factory standard
- Measuring system is insensitive to cooling agents and dust

- Housing and operating keys have an excellent chemical resistance
- Inside cross points
- Locking screw

Functions

- ON / OFF
- Quick-Start
- Quick-Lock (key lock)
- Set to zero at any point
- mm / inch switching
- PRESET-Function (setting a numerical value)
- Variable data output RS 232 + Digimatic + USB

Delivery

- Wooden case

Measuring tips angled inwards	Measuring range		Jaw length		Reading		Order no.	List price EUR
	mm	inch	mm	inch	mm	inch		
Measuring tips angled inwards	0 - 150	0 - 6	40	1.6	0.01	.0005	1326 904	550.00
Measuring jaws angled inwards	0 - 150	0 - 6	40	1.6	0.01	.0005	1326 908	469.00

Accessories



Accessories	Order no.	List price EUR
Battery, 3V-Lithium, CR 2032	0220 704	3.70
Data cable DATA VARIABLE to RS232	1997 501	48.00
Data cable DATA VARIABLE to digimatic	1998 501	61.00
Data cable DATA VARIABLE to USB	1998 720	69.00



1326 DIGI-MET® Pocket calipers for specific measuring tasks



1



Model

- Protection class IP67
- Stainless steel
- LCD display 7.5 mm
- Factory standard
- Measuring system is insensitive to cooling agents and dust

Functions

- Housing and operating keys have an excellent chemical resistance
- Inside cross points
- Locking screw
- ON / OFF
- Quick-Start
- Quick-Lock (key lock)
- Set to zero at any point
- mm / inch switching
- PRESET-Function (setting a numerical value)
- Variable data output RS 232 + Digimatic + USB

Delivery

- Wooden case

Measuring range	Measuring range		Jaw length		Reading		Order no.	List price EUR
	mm	inch	mm	inch	mm	inch		
Measuring jaws angled outwards								
	10.5 - 160	0.4 - 6.3	40	1.6	0.01	.0005	1326 910	539.00
Measuring tips angled outwards								
	20.5 - 170	0.8 - 6.7	40	1.6	0.01	.0005	1326 906	545.00

Accessories



Accessories	Order no.	List price EUR
Battery, 3V-Lithium, CR 2032	0220 704	3.70
Data cable DATA VARIABLE to RS232	1997 501	48.00
Data cable DATA VARIABLE to digimatic	1998 501	61.00
Data cable DATA VARIABLE to USB	1998 720	69.00



0633 Steel gauge block inspection set for calipers



Model

- EN ISO 3650
- Special steel, hardened
- Tolerance class 1
- Supplied with: setting rings 4 mm and 25 mm

Delivery

- Wooden box

⌘	⚙	For measuring range mm	Max. nominal size	Order no.	List price EUR
3 pieces					
		200	30.0 / 41.3 / 131.4	0633 833	540.00
4 pieces					
		300	30.0 / 41.3 / 131.4 / 243.5	0633 834	721.00
6 pieces					
		500	30.0 / 41.3 / 131.4 / 243.5 / 281.2 / 481.1	0633 836	1287.00
5 pieces					
		1000	131.4 / 243.5 / 281.2 / 481.1 / 900	0633 838	2275.00



0230 / 0231 Workshop calipers with parallax-free reading



DIN 862

1

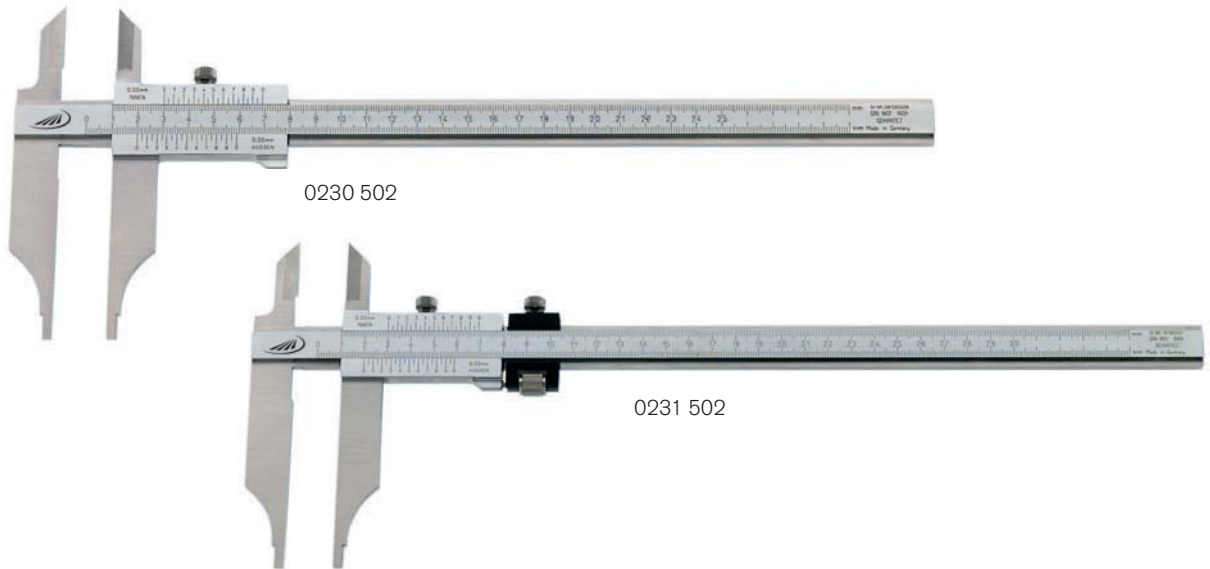

Model

- Parallax-free reading
- Stainless steel
- Reading parts have a satin chrome finish
- DIN 862
- Locking screw
- Knife points

Delivery

- Stepped jaws for inside measurement: 10 mm, for measuring range 500 mm: 20 mm
- Direct reading of internal and external measurements
- High-precision laser graduation on the vernier and scale
- Cardboard box

»	¼	Measuring range		Jaw length		Reading mm	Error limit mm	Order no.	List price EUR
		mm	inch	mm	inch				
Without fine adjustment									
▪		0 - 200	0 - 8	80	3.0	0.05	0.05	0230 501	140.00
▪		0 - 250	0 - 10	80	3.0	0.05	0.05	0230 502	156.00
▪		0 - 300	0 - 12	90	3.5	0.05	0.05	0230 503	171.00
▪		0 - 500	0 - 20	150	6.0	0.05	0.07	0230 508	489.00
With fine adjustment									
▪		0 - 200	0 - 8	80	3.0	0.05	0.05	0231 501	166.00
▪		0 - 250	0 - 10	80	3.0	0.05	0.05	0231 502	182.00
▪		0 - 300	0 - 12	90	3.5	0.05	0.05	0231 503	197.00
▪		0 - 500	0 - 20	150	6.0	0.05	0.07	0231 508	535.00



0234 Workshop calipers



**DIN
862**

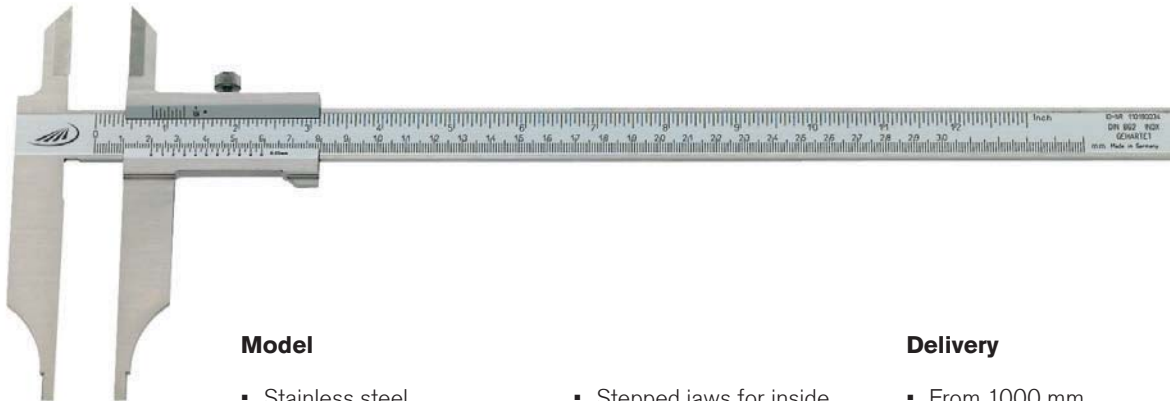

Model

- Stainless steel
- Vernier and / or reading parts have a satin chrome finish
- DIN 862
- Locking screw

Delivery

- From 1000 mm measuring range individually packed

- Stepped jaws for inside measurement: 10 mm, 20 mm* and 30 mm**
- Knife points
- Low-set master scale
- High-precision laser graduation on the vernier and scale

✂	📏	Measuring range		Jaw length		Reading		Error limit	Order no.	List price
		mm	inch	mm	inch	mm	inch			
Vernier satin chrome finished										
▪		0 - 200	0 - 8	80	3.0	0.05	1/128	0.05	0234 201	105.00
▪		0 - 250	0 - 10	80	3.0	0.05	1/128	0.05	0234 202	128.00
▪		0 - 300	0 - 12	90	3.5	0.05	1/128	0.05	0234 203	137.00
▪		0 - 400	0 - 16	125	5.0	0.05		0.06	0234 205*	321.00
▪		0 - 500	0 - 20	150	6.0	0.05		0.07	0234 208*	402.00
▪		0 - 600	0 - 24	150	6.0	0.05		0.08	0234 211*	470.00
▪		0 - 800	0 - 31	150	6.0	0.05		0.1	0234 214*	535.00
▪		0 - 1000	0 - 39	150	6.0	0.05		0.12	0234 218*	649.00
	▪	0 - 1250	0 - 49	200	8.0	0.05		0.16	0234 222**	1038.00
	▪	0 - 1500	0 - 59	200	8.0	0.05		0.18	0234 224**	1342.00
	▪	0 - 2000	0 - 79	200	8.0	0.05		0.22	0234 226**	1960.00
Vernier + scale satin chrome finished										
▪		0 - 200	0 - 8	80	3.0	0.05	1/128	0.05	0234 501	124.00
▪		0 - 250	0 - 10	80	3.0	0.05	1/128	0.05	0234 502	143.00
▪		0 - 300	0 - 12	90	3.5	0.05	1/128	0.05	0234 503	157.00
▪		0 - 400	0 - 16	125	5.0	0.05		0.06	0234 505*	364.00
▪		0 - 500	0 - 20	150	6.0	0.05		0.07	0234 508*	469.00
▪		0 - 600	0 - 24	150	6.0	0.05		0.08	0234 511*	532.00
▪		0 - 800	0 - 31	150	6.0	0.05		0.1	0234 514*	603.00
▪		0 - 1000	0 - 39	150	6.0	0.05		0.12	0234 518*	724.00
	▪	0 - 1250	0 - 49	200	8.0	0.05		0.16	0234 522**	1182.00
	▪	0 - 1500	0 - 59	200	8.0	0.05		0.18	0234 524**	1521.00
	▪	0 - 2000	0 - 79	200	8.0	0.05		0.22	0234 526**	2227.00



0235 Workshop calipers



**DIN
862**

1

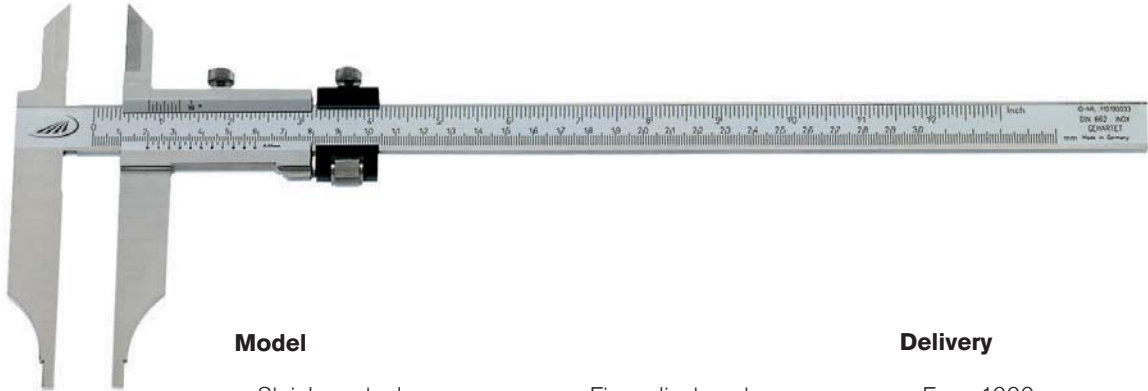

Model

- Stainless steel
- Vernier and / or reading parts have a satin chrome finish
- DIN 862
- Locking screw
- Knife points

Delivery

- From 1000 mm measuring range individually packed

- Fine adjustment
- Stepped jaws for inside measurement: 10 mm, 20 mm* and 30 mm**
- Low-set master scale
- High-precision laser graduation on the vernier and scale

Icon	Measuring range		Jaw length		Reading		Error limit	Order no.	List price	
	mm	inch	mm	inch	mm	inch				mm
Vernier satin chrome finished										
▪	0 - 200	0 - 8	80	3.0	0.05	1/128	0.05	0235 201	132.00	
▪	0 - 250	0 - 10	80	3.0	0.05	1/128	0.05	0235 202	153.00	
▪	0 - 300	0 - 12	90	3.5	0.05	1/128	0.05	0235 203	161.00	
▪	0 - 400	0 - 16	125	5.0	0.05		0.06	0235 205*	371.00	
▪	0 - 500	0 - 20	150	6.0	0.05		0.07	0235 208*	452.00	
▪	0 - 600	0 - 24	150	6.0	0.05		0.08	0235 211*	518.00	
▪	0 - 800	0 - 31	150	6.0	0.05		0.1	0235 214*	594.00	
▪	0 - 1000	0 - 39	150	6.0	0.05		0.12	0235 218*	692.00	
▪	0 - 1250	0 - 49	200	8.0	0.05		0.16	0235 222**	1136.00	
▪	0 - 1500	0 - 59	200	8.0	0.05		0.18	0235 224**	1435.00	
▪	0 - 2000	0 - 79	200	8.0	0.05		0.22	0235 226**	2119.00	
Vernier + scale satin chrome finished										
▪	0 - 200	0 - 8	80	3.0	0.05	1/128	0.05	0235 501	141.00	
▪	0 - 250	0 - 10	80	3.0	0.05	1/128	0.05	0235 502	169.00	
▪	0 - 300	0 - 12	90	3.5	0.05	1/128	0.05	0235 503	181.00	
▪	0 - 400	0 - 16	125	5.0	0.05		0.06	0235 505*	412.00	
▪	0 - 500	0 - 20	150	6.0	0.05		0.07	0235 508*	507.00	
▪	0 - 600	0 - 24	150	6.0	0.05		0.08	0235 511*	577.00	
▪	0 - 800	0 - 31	150	6.0	0.05		0.1	0235 514*	664.00	
▪	0 - 1000	0 - 39	150	6.0	0.05		0.12	0235 518*	784.00	
▪	0 - 1250	0 - 49	200	8.0	0.05		0.16	0235 522**	1268.00	
▪	0 - 1500	0 - 59	200	8.0	0.05		0.18	0235 524**	1613.00	
▪	0 - 2000	0 - 79	200	8.0	0.05		0.22	0235 526**	2376.00	



0236 Workshop calipers



DIN
862

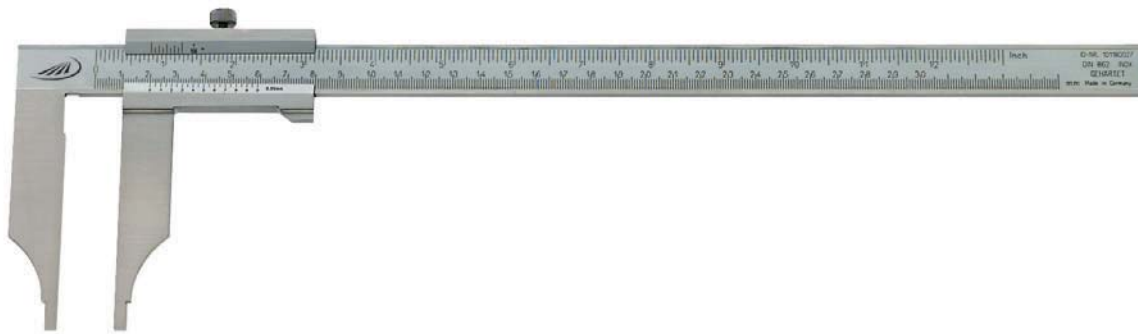

Model

- Stainless steel
- Vernier and / or reading parts have a satin chrome finish
- Factory standard
- Locking screw
- Low-set master scale
- Stepped jaws for inside measurement: 10 mm, 20 mm*, 30 mm** and 50 mm (0236 230)
- High-precision laser graduation on the vernier and scale
- 3000 mm = Factory standard

Delivery

- From 1000 mm measuring range individually packed

⊗	⊗	Measuring range		Jaw length		Reading		Error limit	Order no.	List price
		mm	inch	mm	inch	mm	inch			
Vernier satin chrome finished										
▪		0 - 200	0 - 8	80	3.0	0.05	1/128	0.05	0236 201	90.00
▪		0 - 250	0 - 10	80	3.0	0.05	1/128	0.05	0236 202	110.00
▪		0 - 300	0 - 12	90	3.5	0.05	1/128	0.05	0236 203	124.00
▪		0 - 400	0 - 16	125	5.0	0.05		0.06	0236 205*	254.00
▪		0 - 500	0 - 20	150	6.0	0.05		0.07	0236 208*	335.00
▪		0 - 600	0 - 24	150	6.0	0.05		0.08	0236 211*	401.00
▪		0 - 800	0 - 31	150	6.0	0.05		0.1	0236 214*	428.00
▪		0 - 1000	0 - 39	150	6.0	0.05		0.12	0236 218*	535.00
	▪	0 - 1250	0 - 49	200	8.0	0.05		0.14	0236 222**	828.00
	▪	0 - 1500	0 - 59	200	8.0	0.05		0.18	0236 224**	1129.00
	▪	0 - 2000	0 - 79	200	8.0	0.05		0.22	0236 226**	1556.00
	▪	0 - 3000	0 - 118	200	8.0	0.05		0.22	0236 230	2574.00
Vernier + scale satin chrome finished										
▪		0 - 200	0 - 8	80	3.0	0.05	1/128	0.05	0236 501	103.00
▪		0 - 250	0 - 10	80	3.0	0.05	1/128	0.05	0236 502	130.00
▪		0 - 300	0 - 12	90	3.5	0.05	1/128	0.05	0236 503	140.00
▪		0 - 400	0 - 16	125	5.0	0.05		0.06	0236 505*	297.00
▪		0 - 500	0 - 20	150	6.0	0.05		0.07	0236 508*	391.00
▪		0 - 600	0 - 24	150	6.0	0.05		0.08	0236 511*	467.00
▪		0 - 800	0 - 31	150	6.0	0.05		0.1	0236 514*	484.00
▪		0 - 1000	0 - 39	150	6.0	0.05		0.12	0236 518*	604.00
	▪	0 - 1250	0 - 49	200	8.0	0.05		0.16	0236 522**	992.00
	▪	0 - 1500	0 - 59	200	8.0	0.05		0.18	0236 524**	1331.00
	▪	0 - 2000	0 - 79	200	8.0	0.05		0.22	0236 526**	2006.00



0237 Workshop calipers



DIN
862

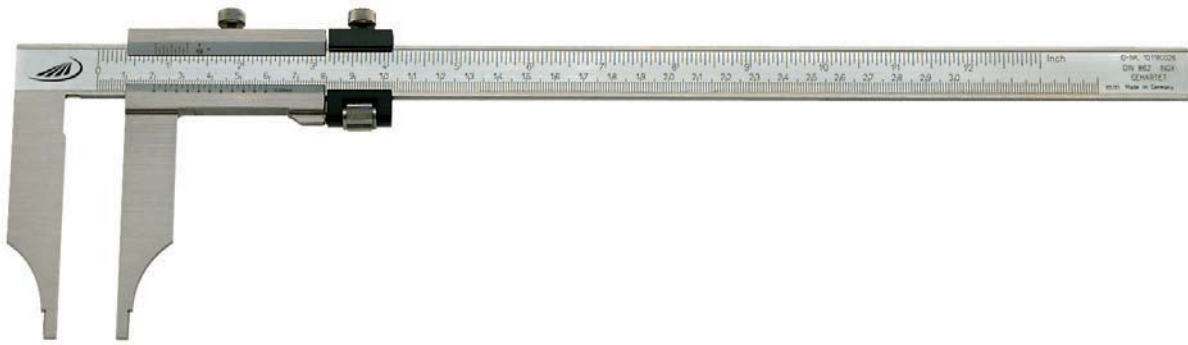

Model

- Stainless steel
- Vernier and / or reading parts have a satin chrome finish
- Factory standard
- Locking screw
- Fine adjustment
- Low-set master scale

Delivery

- Stepped jaws for inside measurement: 10 mm, 20 mm*, 30 mm** and 50 mm (0237 230)
- High-precision laser graduation on the vernier and scale
- 3000 mm = Factory standard

- From 1000 mm measuring range individually packed

Icon	Measuring range		Jaw length		Reading		Error limit	Order no.	List price	
	mm	inch	mm	inch	mm	inch				mm
Vernier satin chrome finished										
▪	0 - 200	0 - 8	80	3.0	0.05	1/128	0.05	0237 201	116.00	
▪	0 - 250	0 - 10	80	3.0	0.05	1/128	0.05	0237 202	137.00	
▪	0 - 300	0 - 12	90	3.5	0.05	1/128	0.05	0237 203	150.00	
▪	0 - 400	0 - 16	125	5.0	0.05		0.06	0237 205*	304.00	
▪	0 - 500	0 - 20	150	6.0	0.05		0.07	0237 208*	387.00	
▪	0 - 600	0 - 24	150	6.0	0.05		0.08	0237 211*	452.00	
▪	0 - 800	0 - 31	150	6.0	0.05		0.1	0237 214*	487.00	
▪	0 - 1000	0 - 39	150	6.0	0.05		0.12	0237 218*	594.00	
▪	0 - 1250	0 - 49	200	8.0	0.05		0.16	0237 222**	922.00	
▪	0 - 1500	0 - 59	200	8.0	0.05		0.18	0237 224**	1224.00	
▪	0 - 2000	0 - 79	200	8.0	0.05		0.22	0237 226**	1710.00	
▪	0 - 3000	0 - 118	200	8.0	0.05		0.22	0237 230	2797.00	
Vernier + scale satin chrome finished										
▪	0 - 200	0 - 8	80	3.0	0.05	1/128	0.05	0237 501	127.00	
▪	0 - 250	0 - 10	80	3.0	0.05	1/128	0.05	0237 502	155.00	
▪	0 - 300	0 - 12	90	3.5	0.05	1/128	0.05	0237 503	167.00	
▪	0 - 400	0 - 16	125	5.0	0.05		0.06	0237 505*	347.00	
▪	0 - 500	0 - 20	150	6.0	0.05		0.07	0237 508*	439.00	
▪	0 - 600	0 - 24	150	6.0	0.05		0.08	0237 511*	514.00	
▪	0 - 800	0 - 31	150	6.0	0.05		0.1	0237 514*	544.00	
▪	0 - 1000	0 - 39	150	6.0	0.05		0.12	0237 518*	665.00	
▪	0 - 1250	0 - 49	200	8.0	0.05		0.16	0237 522**	1083.00	
▪	0 - 1500	0 - 59	200	8.0	0.05		0.18	0237 524**	1424.00	
▪	0 - 2000	0 - 79	200	8.0	0.05		0.22	0237 526**	2158.00	



0236 Workshop calipers with long measuring jaws

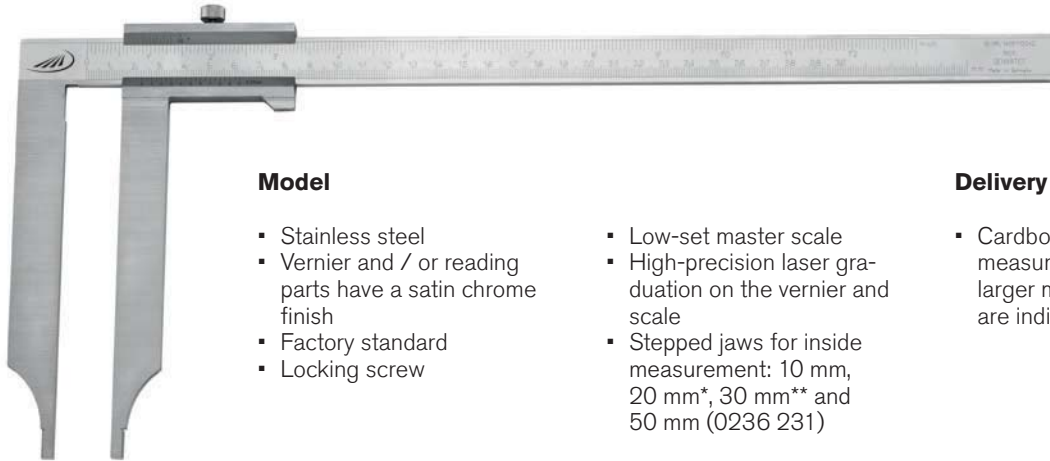

Model

- Stainless steel
- Vernier and / or reading parts have a satin chrome finish
- Factory standard
- Locking screw
- Low-set master scale
- High-precision laser graduation on the vernier and scale
- Stepped jaws for inside measurement: 10 mm, 20 mm*, 30 mm** and 50 mm (0236 231)

Delivery

- Cardboard box up to measuring range 1000 mm. larger measuring ranges are individually packed

Icon	Measuring range		Jaw length		Reading		Error limit	Order no.	List price EUR
	mm	inch	mm	inch	mm	inch			
Vernier satin chrome finished									
	0 - 300	12	150	6.0	0.05	1/128	0.1	0236 204	230.00
	0 - 400	16	150	5.0	0.05		0.1	0236 206*	327.00
	0 - 400	16	200	8.0	0.05		0.12	0236 207*	399.00
	0 - 500	20	200	8.0	0.05		0.14	0236 209*	444.00
	0 - 500	20	250	10.0	0.05		0.14	0236 210*	535.00
	0 - 600	24	200	8.0	0.05		0.16	0236 212*	557.00
	0 - 600	24	300	12.0	0.05		0.16	0236 213*	685.00
	0 - 800	31	200	8.0	0.05		0.2	0236 215*	644.00
	0 - 800	31	300	12.0	0.05		0.2	0236 216*	824.00
	0 - 800	31	400	16.0	0.05		0.2	0236 217*	957.00
	0 - 1000	39	200	8.0	0.05		0.24	0236 219*	791.00
	0 - 1000	39	300	12.0	0.05		0.24	0236 220*	883.00
	0 - 1000	39	500	20.0	0.05		0.24	0236 221*	1331.00
▪	0 - 1500	59	300	12.0	0.05		0.36	0236 225**	1365.00
▪	0 - 2000	79	300	12.0	0.05		0.44	0236 227**	1899.00
▪	0 - 3000	118	300	12.0	0.05		0.64	0236 231	3139.00
Vernier + scale satin chrome finished									
	0 - 300	12	150	6.0	0.05	1/128	0.1	0236 504	248.00
	0 - 400	16	150	6.0	0.05		0.12	0236 506*	381.00
	0 - 400	16	200	8.0	0.05		0.12	0236 507*	463.00
	0 - 500	20	200	8.0	0.05		0.14	0236 509*	514.00
	0 - 500	20	250	10.0	0.05		0.14	0236 510*	614.00
	0 - 600	24	200	8.0	0.05		0.16	0236 512*	581.00
	0 - 600	24	300	12.0	0.05		0.16	0236 513*	756.00
	0 - 800	31	200	8.0	0.05		0.2	0236 515*	748.00
	0 - 800	31	300	12.0	0.05		0.2	0236 516*	954.00
	0 - 800	31	400	16.0	0.05		0.2	0236 517*	1119.00
	0 - 1000	39	200	8.0	0.05		0.24	0236 519*	917.00
	0 - 1000	39	300	12.0	0.05		0.24	0236 520*	1157.00
	0 - 1000	39	500	20.0	0.05		0.24	0236 521*	1581.00
▪	0 - 1500	59	300	12.0	0.05		0.36	0236 525**	1624.00
▪	0 - 2000	79	300	12.0	0.05		0.44	0236 527**	2405.00



0237 Workshop calipers with long measuring jaws

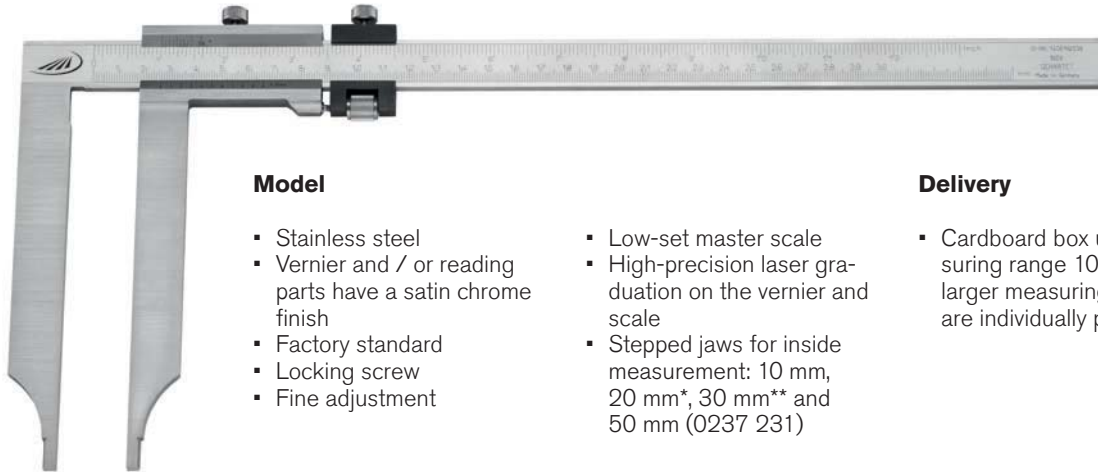

Model

- Stainless steel
- Vernier and / or reading parts have a satin chrome finish
- Factory standard
- Locking screw
- Fine adjustment
- Low-set master scale
- High-precision laser graduation on the vernier and scale
- Stepped jaws for inside measurement: 10 mm, 20 mm*, 30 mm** and 50 mm (0237 231)

Delivery

- Cardboard box up to measuring range 1000 mm, larger measuring ranges are individually packed

Icon	Measuring range		Jaw length		Reading		Error limit	Order no.	List price	
	mm	inch	mm	inch	mm	inch				mm
Vernier satin chrome finished										
	0 - 300	0 - 12	150	6.0	0.05	1/128	0.1	0237 204	255.00	
	0 - 400	0 - 16	150	6.0	0.05		0.12	0237 206*	377.00	
	0 - 400	0 - 16	200	8.0	0.05		0.12	0237 207*	450.00	
	0 - 500	0 - 20	200	8.0	0.05		0.14	0237 209*	496.00	
	0 - 500	0 - 20	250	10.0	0.05		0.14	0237 210*	585.00	
	0 - 600	0 - 24	200	8.0	0.05		0.16	0237 212*	605.00	
	0 - 600	0 - 24	300	8.0	0.05		0.16	0237 213*	736.00	
	0 - 800	0 - 31	200	8.0	0.05		0.2	0237 215*	707.00	
	0 - 800	0 - 31	300	12.0	0.05		0.2	0237 216*	885.00	
	0 - 800	0 - 31	400	16.0	0.05		0.2	0237 217*	1019.00	
	0 - 1000	0 - 39	200	8.0	0.05		0.24	0237 219*	854.00	
	0 - 1000	0 - 39	300	12.0	0.05		0.24	0237 220*	945.00	
	0 - 1000	0 - 39	500	20.0	0.05		0.24	0237 221*	1392.00	
▪	0 - 1500	0 - 59	300	12.0	0.05		0.36	0237 225**	1460.00	
▪	0 - 2000	0 - 79	300	12.0	0.05		0.44	0237 227**	2052.00	
▪	0 - 3000	0 - 118	300	12.0	0.05		0.64	0237 231	3361.00	
Vernier + scale satin chrome finished										
	0 - 300	0 - 12	150	6.0	0.05	1/128	0.1	0237 504	272.00	
	0 - 400	0 - 16	150	6.0	0.05		0.12	0237 506*	430.00	
	0 - 400	0 - 16	200	8.0	0.05		0.12	0237 507*	512.00	
	0 - 500	0 - 20	200	8.0	0.05		0.14	0237 509*	562.00	
	0 - 500	0 - 20	250	10.0	0.05		0.14	0237 510*	663.00	
	0 - 600	0 - 24	200	8.0	0.05		0.16	0237 512*	676.00	
	0 - 600	0 - 24	300	12.0	0.05		0.16	0237 513*	807.00	
	0 - 800	0 - 31	200	8.0	0.05		0.2	0237 515*	809.00	
	0 - 800	0 - 31	300	12.0	0.05		0.2	0237 516*	1012.00	
	0 - 800	0 - 31	400	16.0	0.05		0.2	0237 517*	1181.00	
	0 - 1000	0 - 39	200	8.0	0.05		0.24	0237 519*	975.00	
	0 - 1000	0 - 39	300	12.0	0.05		0.24	0237 520*	1218.00	
	0 - 1000	0 - 39	500	20.0	0.05		0.24	0237 521*	1644.00	
▪	0 - 1500	0 - 59	300	12.0	0.05		0.36	0237 525**	1720.00	
▪	0 - 2000	0 - 79	300	12.0	0.05		0.44	0237 527**	2556.00	



0219 Workshop dial caliper



DIN
862



Model

- Stainless steel
- Satin chrome scale
- DIN 862
- Stepped jaws for inside measurement 10 mm
- Locking screw

Delivery

- Wooden case

⊗	Measuring range		Jaw length		Reading	Error limit	Depth gauge	Order no.	List price
	mm	inch	mm	inch	mm	mm	mm		EUR
▪	0 - 300	0 - 12	90	3.5	0.05	0.05	rect.	0219 503	288.00

0238 Lightweight workshop calipers

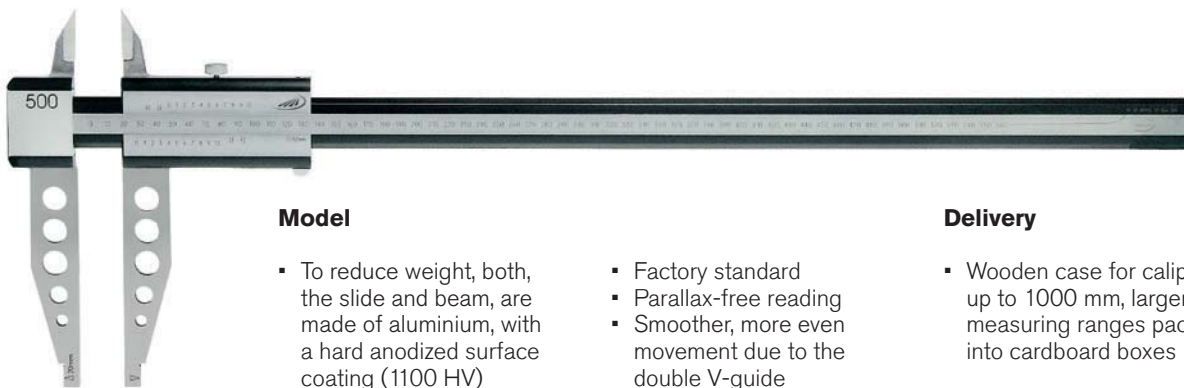

Model

- To reduce weight, both, the slide and beam, are made of aluminium, with a hard anodized surface coating (1100 HV)
- Measuring faces are made of hardened stainless steel

Delivery

- Factory standard
- Parallax-free reading
- Smoother, more even movement due to the double V-guide
- Locking screw
- Knife points
- Stepped jaws for inside measurement 20 mm
- Wooden case for calipers up to 1000 mm, larger measuring ranges packed into cardboard boxes

⊗	Measuring range		Jaw length		Reading	Error limit	Order no.	List price
	mm	inch	mm	inch	mm	mm		EUR
	0 - 300	0 - 12	90	3.5	0.02	0.05	0238 503	364.00
	0 - 500	0 - 20	150	6.0	0.02	0.07	0238 508	520.00
	0 - 800	0 - 31	150	6.0	0.02	0.1	0238 514	695.00
	0 - 1000	0 - 39	150	6.0	0.02	0.12	0238 518	814.00
▪	0 - 1500	0 - 59	200	8.0	0.05	0.17	0238 524	2110.00
▪	0 - 2000	0 - 79	200	8.0	0.05	0.22	0238 526	2457.00



0265 Caliper with cross points



1

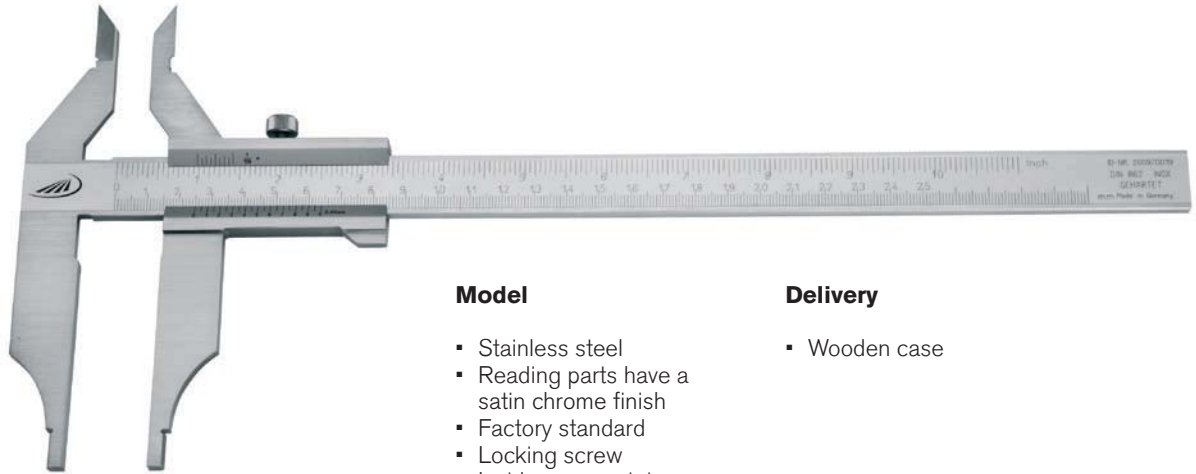

Model

- Stainless steel
- Reading parts have a satin chrome finish
- Factory standard
- Locking screw
- Inside cross points 55 mm

Delivery

- Wooden case

✕	Measuring range		Jaw length		Reading	Error limit	Order no.	List price
	mm	inch	mm	inch	mm	mm		EUR
	0 - 250	0 - 10	80	3.1	0.02	0.03	026652 005	259.00

0266 Caliper with gripper points



Model

- Stainless steel
- Reading parts have a satin chrome finish
- Factory standard
- Locking screw
- Gripper points 55 mm

Delivery

- Wooden case

✕	Measuring range		Jaw length		Reading	Error limit	Order no.	List price
	mm	inch	mm	inch	mm	mm		EUR
	0 - 250	0 - 10	75	3.0	0.02	0.03	026652 005	347.00



1330 / 1331 DIGI-MET® Workshop calipers



Model

- Stainless steel
- Inductive measuring system, resistant to damp and sweat
- DIN 862
- Knife points
- LCD display:
 - 10 mm with measuring range 300 mm;
 - 12.5 mm from measuring range 500 mm
- Locking screw

Functions

- ON / OFF
- **Quick-Start**
- **Quick-Lock** (key lock)
- Set to zero at any point
- mm / inch switching
- PRESET-Function (setting a numerical value)
- Variable data output RS 232 + Digimatic + USB

Delivery

- Wooden case

Icon	Measuring range		Jaw length		Reading		Error limit	Order no.	List price
	mm	inch	mm	inch	mm	inch			
With knife points, without fine adjustment									
▪	0 - 300	0 - 12	90	3.5	0.01	.0005	0.03	1330 522	384.00
▪	0 - 500	0 - 20	125	5.0	0.01	.0005	0.03	1330 528	583.00
▪	0 - 800	0 - 31	150	6.0	0.01	.0005	0.04	1330 532	952.00
▪	0 - 1000	0 - 39	150	6.0	0.01	.0005	0.04	1330 534	1152.00
With knife points, with fine adjustment									
▪	0 - 300	0 - 12	90	3.5	0.01	.0005	0.03	1331 522	443.00
▪	0 - 500	0 - 20	125	5.0	0.01	.0005	0.03	1331 528	654.00
▪	0 - 800	0 - 31	150	6.0	0.01	.0005	0.04	1331 532	1007.00
▪	0 - 1000	0 - 39	150	6.0	0.01	.0005	0.04	1331 534	1157.00

Accessories



1998720

1997501

1998501

Battery, 3V-Lithium, CR 2032

Data cable DATA VARIABLE to USB

Data cable DATA VARIABLE to RS232

Data cable DATA VARIABLE to digimatic

Order no.

0220 704

1998 720

1997 501

1998 501

List price

EUR

3.70

69.00

48.00

61.00



1334 / 1335 DIGI-MET® Workshop calipers



1



Model

- Stainless steel
- Inductive measuring system, resistant to damp and sweat
- DIN 862
- LCD display:
 - 10 mm with measuring range 300 mm;
 - 12.5 mm from measuring range 500 mm
- Locking screw

Functions

- ON / OFF
- **Quick-Start**
- **Quick-Lock** (key lock)
- Set to zero at any point
- mm / inch switching
- PRESET-Function (setting a numerical value)
- Variable data output RS 232 + Digimatic + USB

Delivery

- Wooden case

Icon	Measuring range		Jaw length		Reading		Error limit	Order no.	List price
	mm	inch	mm	inch	mm	inch			
Without fine adjustment									
▪	0 - 300	0 - 12	90	3.5	0.01	.0005	0.03	1334 522	354.00
▪	0 - 500	0 - 20	125	5.0	0.01	.0005	0.03	1334 528	497.00
▪	0 - 800	0 - 31	150	6.0	0.01	.0005	0.04	1334 532	869.00
▪	0 - 1000	0 - 39	150	6.0	0.01	.0005	0.04	1334 534	1028.00
With fine adjustment									
▪	0 - 300	0 - 12	90	3.5	0.01	.0005	0.03	1335 522	405.00
▪	0 - 500	0 - 20	125	5.0	0.01	.0005	0.03	1335 528	572.00
▪	0 - 800	0 - 31	150	6.0	0.01	.0005	0.04	1335 532	934.00
▪	0 - 1000	0 - 39	150	6.0	0.01	.0005	0.04	1335 534	1073.00



1998720

1997501

1998501

Accessories

	Order no.	List price
Battery, 3V-Lithium, CR 2032	0220 704	3.70
Data cable DATA VARIABLE to USB	1998 720	69.00
Data cable DATA VARIABLE to RS232	1997 501	48.00
Data cable DATA VARIABLE to digimatic	1998 501	61.00



1340 / 1341 DIGI-MET® Workshop calipers IP65



Model

- Stainless steel
- Inductive measuring system, protection class IP65
- DIN 862
- Knife points
- LCD display:
 - 10 mm with measuring range 300 mm;
 - 12.5 mm from measuring range 500 mm
- Locking screw

Functions

- ON / OFF
- **Quick-Start**
- **Quick-Lock** (key lock)
- Set to zero at any point
- mm / inch switching
- PRESET-Function (setting a numerical value)
- Variable data output RS 232 + Digimatic + USB

Delivery

- Wooden case

	Measuring range		Jaw length		Reading		Error limit	Order no.	List price	
	mm	inch	mm	inch	mm	inch				mm
With knife points, without fine adjustment										
▪	0 - 300	0 - 12	90	3.5	0.01	.0005	0.03	1340 522	414.00	
▪	0 - 500	0 - 20	125	5.0	0.01	.0005	0.03	1340 528	789.00	
▪	0 - 800	0 - 31	150	6.0	0.01	.0005	0.04	1340 532	1065.00	
▪	0 - 1000	0 - 39	150	6.0	0.01	.0005	0.04	1340 534	1310.00	
With knife points, with fine adjustment										
▪	0 - 300	0 - 12	90	3.5	0.01	.0005	0.03	1341 522	468.00	
▪	0 - 500	0 - 20	125	5.0	0.01	.0005	0.03	1341 528	843.00	
▪	0 - 800	0 - 31	150	6.0	0.01	.0005	0.04	1341 532	1118.00	
▪	0 - 1000	0 - 39	150	6.0	0.01	.0005	0.04	1341 534	1363.00	



1998720

1997501

1998501

Accessories

- Battery, 3V-Lithium, CR 2032
- Data cable DATA VARIABLE to USB
- Data cable DATA VARIABLE to RS232
- Data cable DATA VARIABLE to digimatic

Order no.

List price

EUR

0220 704

3.70

1998 720

69.00

1997 501

48.00

1998 501

61.00



HELIOS · PREISSER

1342 / 1343 DIGI-MET® Workshop calipers IP65



1

Model

- Stainless steel
- Inductive measuring system, protection class IP65
- DIN 862
- LCD display:
 - 10 mm with measuring range 300 mm;
 - 12.5 mm from measuring range 500 mm
- Locking screw

Functions

- ON / OFF
- **Quick-Start**
- **Quick-Lock** (key lock)
- Set to zero at any point
- mm / inch switching
- PRESET-Function (setting a numerical value)
- Variable data output RS 232 + Digimatic + USB

Delivery

- Wooden case

Icon	Measuring range		Jaw length		Reading		Error limit	Order no.	List price
	mm	inch	mm	inch	mm	inch			
Without fine adjustment									
▪	0 - 300	0 - 12	90	3.5	0.01	.0005	0.03	1342 522	380.00
▪	0 - 500	0 - 20	125	5.0	0.01	.0005	0.03	1342 528	702.00
▪	0 - 800	0 - 31	150	6.0	0.01	.0005	0.04	1342 532	971.00
▪	0 - 1000	0 - 39	150	6.0	0.01	.0005	0.04	1342 534	1208.00
With fine adjustment									
▪	0 - 300	0 - 12	90	3.5	0.01	.0005	0.03	1343 522	434.00
▪	0 - 500	0 - 20	125	5.0	0.01	.0005	0.03	1343 528	756.00
▪	0 - 800	0 - 31	150	6.0	0.01	.0005	0.04	1343 532	1025.00
▪	0 - 1000	0 - 39	150	6.0	0.01	.0005	0.04	1343 534	1261.00



Accessories

	Order no.	List price
Battery, 3V-Lithium, CR 2032	0220 704	3.70
Data cable DATA VARIABLE to USB	1998 720	69.00
Data cable DATA VARIABLE to RS232	1997 501	48.00
Data cable DATA VARIABLE to digimatic	1998 501	61.00



0222 / 0223 DIGI-MET® Workshop calipers long version

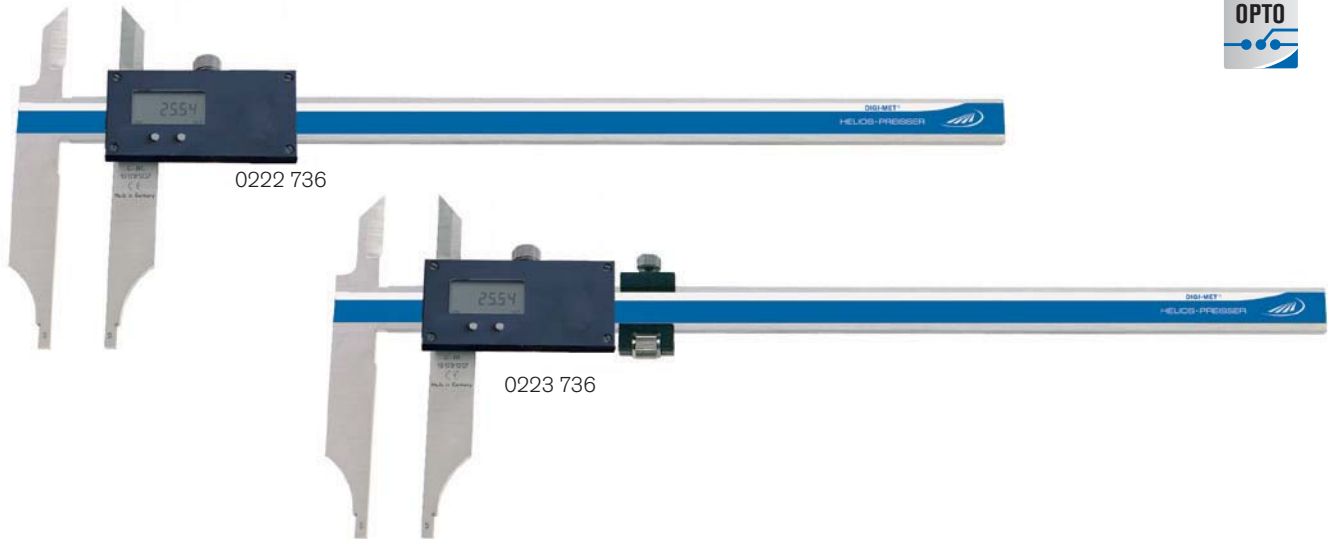

Model

- Stainless steel
- LCD display 10 mm
- Locking screw
- Knife points
- Factory standard

Functions

- ON / OFF
- Set to zero at any point
- mm / inch switching
- Hold
- Data output Opto RS 232
- PRESET-Function (setting a numerical value)

Delivery

- Wooden case

▶◀	🏠	Measuring range		Jaw length		Reading		Error limit mm	Order no.	List price EUR
		mm	inch	mm	inch	mm	inch			
With knife points, without fine adjustment										
	▪	0 - 1500	0 - 59	200	8.0	0.01	.0005	0.1	0222 734	2569.00
	▪	0 - 2000	0 - 79	200	8.0	0.01	.0005	0.12	0222 736	3083.00
With knife points, with fine adjustment										
	▪	0 - 1500	0 - 59	200	8.0	0.01	.0005	0.1	0223 734	2741.00
	▪	0 - 2000	0 - 79	200	8.0	0.01	.0005	0.12	0223 736	3176.00



Accessories

	Order no.	List price EUR
Battery, 3V-Lithium, CR 2032	0220 704	3.70
Data cable opto to RS232	0996 701	74.00
Data cable opto to USB	0996 705	141.00
USB-keyboard interface cable	0997 770	241.00



0224 / 0225 DIGI-MET® Workshop calipers long version



1



0224 736



0225 736

Model

- Stainless steel
- LCD display 10 mm
- Locking screw
- Without knife points
- Factory standard

Functions

- ON / OFF
- Set to zero at any point
- mm / inch switching
- Hold
- Data output Opto RS 232
- PRESET-Function (setting a numerical value)

Delivery

- Wooden case

Icon	Measuring range		Jaw length		Reading		Error limit	Order no.	List price EUR
	mm	inch	mm	inch	mm	inch	mm		
Without fine adjustment									
▪	0 - 1500	0 - 59	200	8.0	0.01	.0005	0.1	0224 734	2323.00
▪	0 - 2000	0 - 79	200	8.0	0.01	.0005	0.12	0224 736	2816.00
With fine adjustment									
▪	0 - 1500	0 - 59	200	8.0	0.01	.0005	0.1	0225 734	2449.00
▪	0 - 2000	0 - 79	200	8.0	0.01	.0005	0.12	0225 736	2907.00



0996705

0996701

0997770

Accessories

	Order no.	List price EUR
Battery, 3V-Lithium, CR 2032	0220 704	3.70
Data cable opto to RS232	0996 701	74.00
Data cable opto to USB	0996 705	141.00
USB-keyboard interface cable	0997 770	241.00



1351 DIGI-MET® Workshop calipers with cross points



1351 522

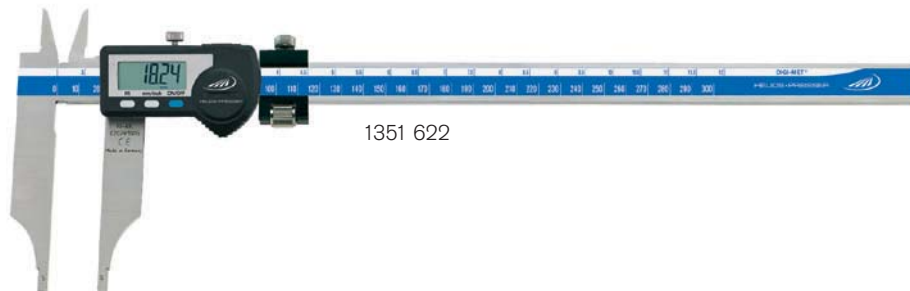

1351 622

Model

- Stainless steel
- DIN 862
- LCD display
- 10 mm with measuring range 300 mm;
- 12.5 mm from measuring range 500 mm
- Locking screw
- Inside cross points
- Three way measurement

Functions

- ON / OFF
- **Quick-Start**
- **Quick-Lock** (key lock)
- Set to zero at any point
- mm / inch switching
- PRESET-Function (setting a numerical value)
- Variable data output RS 232 + Digimatic + USB

Delivery

- Wooden case

Measuring range	Jaw length		Reading		Error limit	Order no.	List price EUR	
	mm	inch	mm	inch				mm
Without fine adjustment								
0 - 300	0 - 12	90	3.5	0.01	.0005	0.03	1351 522	532.00
0 - 500	0 - 20	125	5.0	0.01	.0005	0.03	1351 528	688.00
With fine adjustment								
0 - 300	0 - 12	90	3.5	0.01	.0005	0.03	1351 622	567.00
0 - 500	0 - 20	125	5.0	0.01	.0005	0.03	1351 628	752.00



1998720

1997501

1998501

Accessories

	Order no.	List price EUR
Battery, 3V-Lithium, CR 2032	0220 704	3.70
Data cable DATA VARIABLE to USB	1998 720	69.00
Data cable DATA VARIABLE to digimatic	1998 501	61.00
Data cable DATA VARIABLE to RS232	1997 501	48.00



1338 DIGI-MET® Workshop caliper PRISMA



1

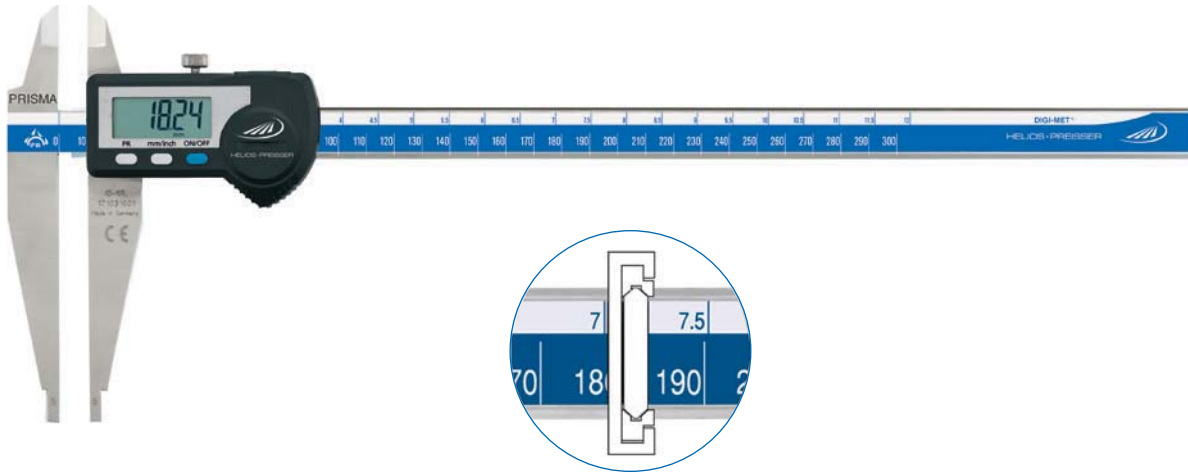

Model

- Double prisma guide with excellent sliding characteristics
- Stainless steel
- Accuracy in accordance to DIN 862
- LCD display 10 mm
- Locking screw
- Knife points
- Stepped jaws for inside measurement 10 mm

Functions

- ON / OFF
- **Quick-Start**
- **Quick-Lock** (key lock)
- Set to zero at any point
- mm / inch switching
- PRESET-Function (setting a numerical value)
- Variable data output RS 232 + Digimatic + USB

Delivery

- Wooden case

▣	Measuring range		Jaw length		Reading		Error limit	Order no.	List price
	mm	inch	mm	inch	mm	inch	mm		EUR
▪	0 - 300	0 - 12	90	3.5	0.01	.0005	0.03	1338 522	456.00



Accessories

	Order no.	List price
		EUR
Battery, 3V-Lithium, CR 2032	0220 704	3.70
Data cable DATA VARIABLE to RS232	1997 501	48.00
Data cable DATA VARIABLE to digimatic	1998 501	61.00
Data cable DATA VARIABLE to USB	1998 720	69.00



0228 DIGI-MET® Workshop calipers lightweight

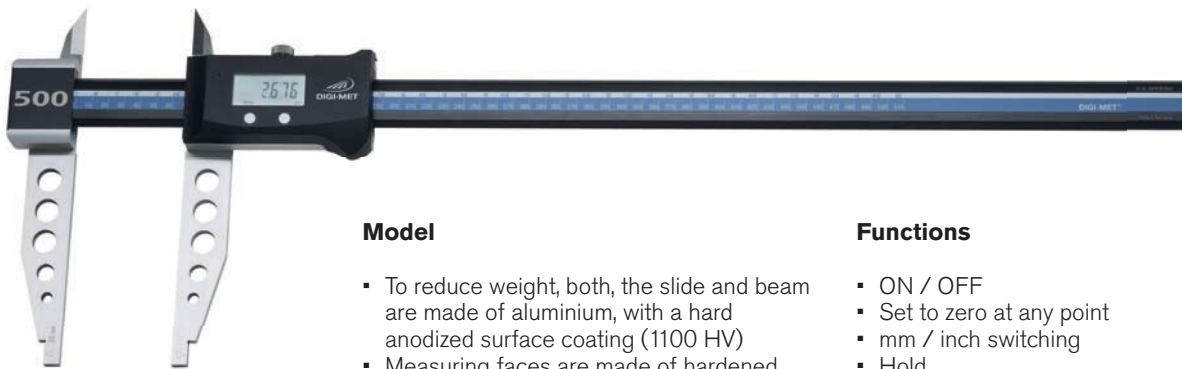

Model

- To reduce weight, both, the slide and beam are made of aluminium, with a hard anodized surface coating (1100 HV)
- Measuring faces are made of hardened stainless steel
- Factory standard
- Smoother, more even movement due to the double V-guide
- LCD display
- Locking screw
- Knife points

Functions

- ON / OFF
- Set to zero at any point
- mm / inch switching
- Hold
- PRESET-Function (setting a numerical value)

Delivery

- Wooden case

✕	📏	Measuring range		Jaw length		Reading		Error limit	Order no.	List price
		mm	inch	mm	inch	mm	inch	mm		EUR
		0 - 300	0 - 12	90	3.5	0.01	.0005	0.03	0228 701	473.00
		0 - 500	0 - 20	150	6.0	0.01	.0005	0.03	0228 702	658.00
		0 - 800	0 - 31	150	6.0	0.01	.0005	0.08	0228 703	925.00
		0 - 1000	0 - 39	150	6.0	0.01	.0005	0.08	0228 704	1091.00
	▪	0 - 1500	0 - 59	150	6.0	0.01	.0005	0.1	0228 724	2753.00
	▪	0 - 2000	0 - 79	150	6.0	0.01	.0005	0.12	0228 726	3273.00

Accessories

Battery, 3V-Lithium, CR 2032

Order no.

0220 704

List price

EUR
3.70

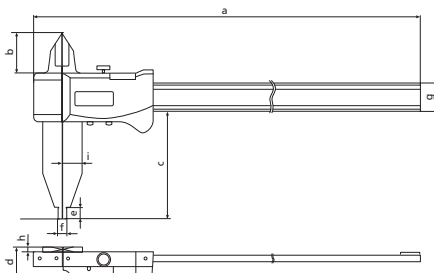

Measuring range	a	b	c	d	e	f	g	h	i
300	450	33	90	24.5	10	10	25.0	4.5	17.0
500	726	42	150	33.5	15	20	31.9	6.0	29.0
800	1026	42	150	33.5	15	20	31.9	6.0	29.0
1000	1226	42	150	33.5	15	20	31.9	6.0	29.0
1500	1726	42	200	33.5	15	20	31.9	6.0	29.0
2000	2226	42	200	33.5	15	20	31.9	6.0	29.0



HELIOS · PREISSER

1351 DIGI-MET® Caliper with cross points

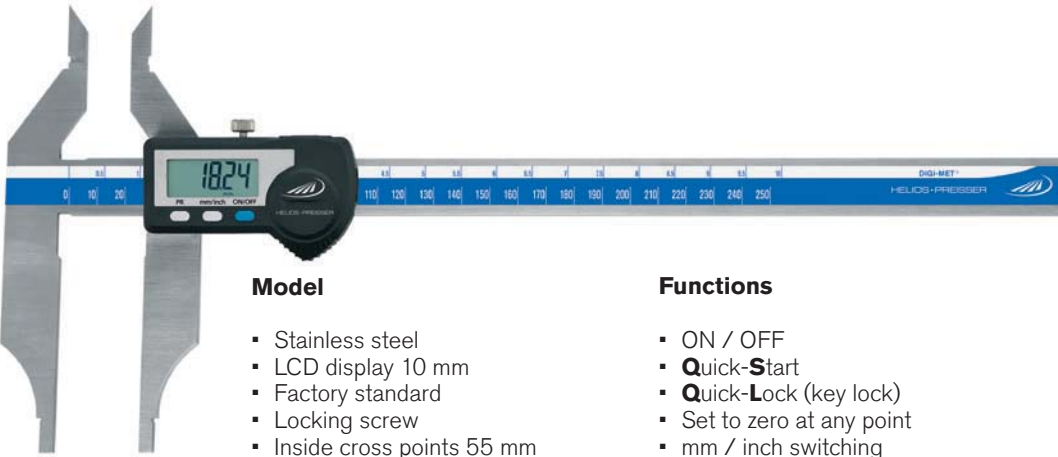

Model

- Stainless steel
- LCD display 10 mm
- Factory standard
- Locking screw
- Inside cross points 55 mm

Functions

- ON / OFF
- **Quick-Start**
- **Quick-Lock** (key lock)
- Set to zero at any point
- mm / inch switching
- PRESET-Function (setting a numerical value)
- Variable data output RS 232 + Digimatic + USB

Delivery

- Wooden case

Measuring range	Jaw length		Reading		Error limit	Order no.	List price	
	mm	inch	mm	inch				mm
0 - 250	0 - 10	80	3.2	0.01	.0005	0.03	1351 920	479.00



1354 DIGI-MET® Caliper with gripper points

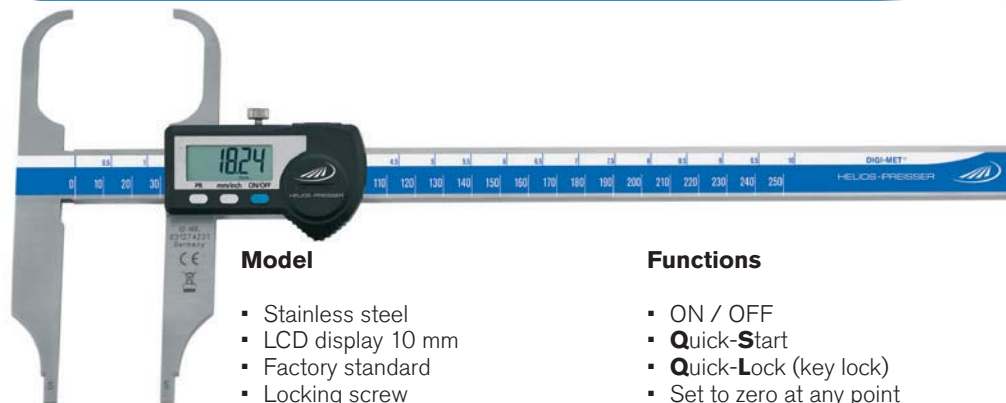

Model

- Stainless steel
- LCD display 10 mm
- Factory standard
- Locking screw
- Gripper points 55 mm

Functions

- ON / OFF
- **Quick-Start**
- **Quick-Lock** (key lock)
- Set to zero at any point
- mm / inch switching
- Hold
- PRESET-Function (setting a numerical value)

- Variable data output RS 232 + Digimatic + USB

Delivery

- Wooden case

Measuring range	Jaw length		Reading		Error limit	Order no.	List price	
	mm	inch	mm	inch				mm
0 - 250	0 - 10	75	3.0	0.01	.0005	0.03	1354 520	566.00



1998720 1997501 1998501

Accessories

	Order no.	List price
		EUR
Battery, 3V-Lithium, CR 2032	0220 704	3.70
Data cable DATA VARIABLE to RS232	1997 501	48.00
Data cable DATA VARIABLE to digimatic	1998 501	61.00
Data cable DATA VARIABLE to USB	1998 720	69.00



1348 DIGI-MET® Universal calipers

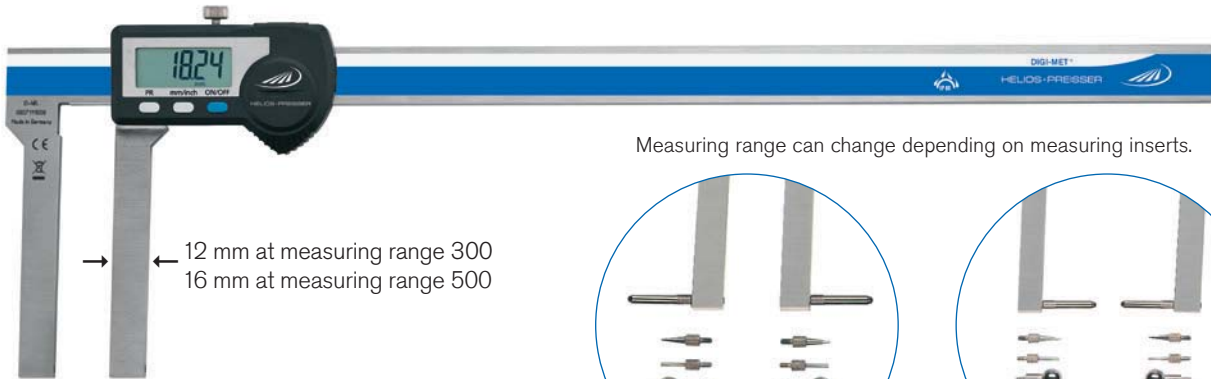

→ ← 12 mm at measuring range 300
16 mm at measuring range 500

Measuring range can change depending on measuring inserts.

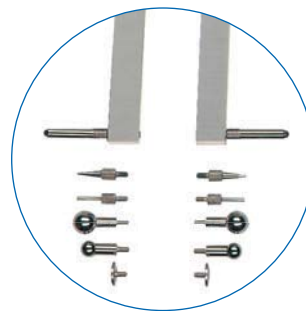

for internal measurements

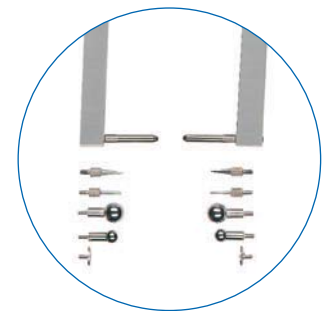

for external measurements

Model

- Stainless steel
- Factory standard
- LCD display 10 or 12.5 mm
- Locking screw
- For internal and external measurements
- Individually adaptable on problematic tasks through measuring inserts with thread M 2.5

Functions

- ON / OFF
- **Quick-Start**
- **Quick-Lock** (key lock)
- Set to zero at any point
- mm / inch switching
- PRESET-Function (setting a numerical value)
- Variable data output RS 232 + Digimatic + USB

Delivery

- Wooden box
- Without measuring inserts
(correct measuring inserts with thread M 2.5 see pages 137 - 140)

⊗	Measuring range		Jaw length		Reading		Error limit	Order no.	List price EUR
	mm	inch	mm	inch	mm	inch	mm		
	0 - 300	0 - 12	90	3.5	0.01	.0005	0.06	1348 722	583.00
	0 - 500	0 - 20	100	4.0	0.01	.0005	0.06	1348 728	747.00



1998720 1998501 1997501

Accessories

	Order no.	List price EUR
Battery, 3V-Lithium, CR 2032	0220 704	3.70
Data cable DATA VARIABLE to RS232	1997 501	48.00
Data cable DATA VARIABLE to digimatic	1998 501	61.00
Data cable DATA VARIABLE to USB	1998 720	69.00



0250 Contraction vernier calipers

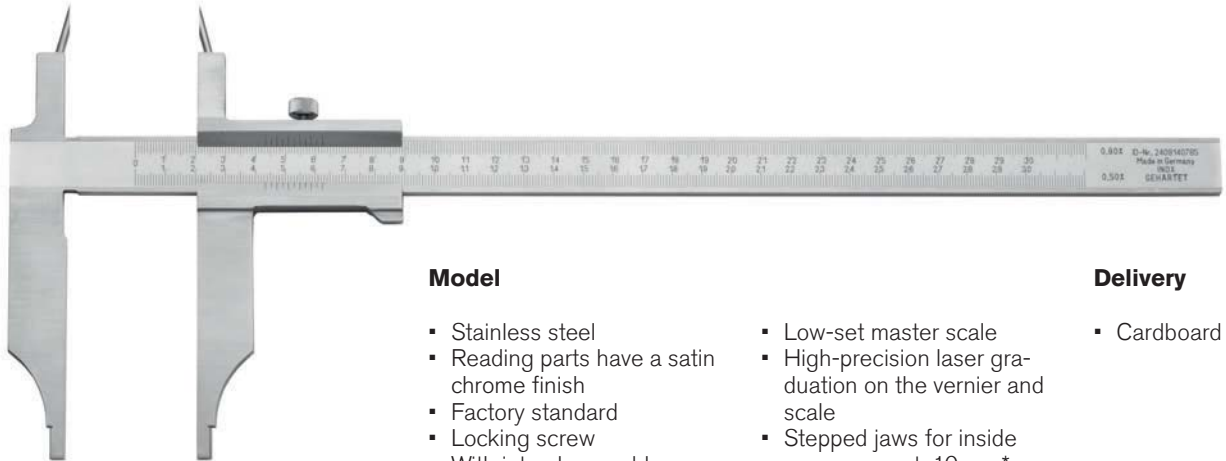

Model

- Stainless steel
- Reading parts have a satin chrome finish
- Factory standard
- Locking screw
- With interchangeable hardened scribing jaws
- Low-set master scale
- High-precision laser graduation on the vernier and scale
- Stepped jaws for inside measurement: 10 mm* and / or 20 mm

Delivery

- Cardboard box

Measuring range mm	Jaw length mm	Reading mm	Order no.	List price EUR
Direct reading for internal and external measurement				
0 - 300	90	0.05	0250 501*	245.00
0 - 500	150	0.05	0250 502	667.00
0 - 600	150	0.05	0250 503	791.00
0 - 800	150	0.05	0250 504	998.00
0 - 1000	150	0.05	0250 505	1213.00
Contraction scale divisions 1.0% - 1.5% - 2.0% - 1/1 mm				
0 - 300	90	0.1	0250 511*	264.00
0 - 500	150	0.1	0250 512	700.00
0 - 600	150	0.1	0250 513	832.00
0 - 800	150	0.1	0250 514	1070.00
0 - 1000	150	0.1	0250 515	1300.00
Contraction scale divisions 0.5% - 0.8% - 1.0% - 1/1 mm				
0 - 300	90	0.1	0250 521*	264.00
0 - 500	150	0.1	0250 522	700.00
0 - 600	150	0.1	0250 523	832.00
0 - 800	150	0.1	0250 524	1070.00
0 - 1000	150	0.1	0250 525	1300.00
Contraction scale divisions 1.0% - 1.25% - 1.5% - 1/1 mm				
0 - 300	90	0.1	0250 531*	264.00
0 - 500	150	0.1	0250 532	700.00
0 - 600	150	0.1	0250 533	832.00
0 - 800	150	0.1	0250 534	1070.00
0 - 1000	150	0.1	0250 535	1300.00
Contraction scale divisions 1.75% - 2.0% - 2.5% - 1/1 mm				
0 - 300	90	0.1	0250 541*	264.00
0 - 500	150	0.1	0250 542	700.00
0 - 600	150	0.1	0250 543	832.00
0 - 800	150	0.1	0250 544	1070.00
0 - 1000	150	0.1	0250 545	1300.00



0250 Contraction vernier calipers



» ¼	Measuring range mm	Jaw length mm	Reading mm	Order no.	List price EUR
Contraction scale divisions 1.0% - 1.25% - 2.0% - 1/1 mm					
	0 - 300	90	0.1	0250 551*	264.00
	0 - 500	150	0.1	0250 552	700.00
	0 - 600	150	0.1	0250 553	832.00
	0 - 800	150	0.1	0250 554	1070.00
	0 - 1000	150	0.1	0250 555	1300.00
Contraction scale divisions 0.3% - 0.4% - 0.6% - 1/1 mm					
	0 - 300	90	0.1	0250 561*	264.00
	0 - 500	150	0.1	0250 562	700.00
	0 - 600	150	0.1	0250 563	832.00
	0 - 800	150	0.1	0250 564	1070.00
	0 - 1000	150	0.1	0250 565	1300.00
Contraction scale divisions 1.0% - 1.25% - 1.5% - 2.0%					
	0 - 300	90	0.1	0250 571*	277.00
	0 - 500	150	0.1	0250 572	772.00
	0 - 600	150	0.1	0250 573	918.00
	0 - 800	150	0.1	0250 574	1155.00
	0 - 1000	150	0.1	0250 575	1403.00

0250 Interchangeable points (pair) for contraction vernier calipers



Model

- Ø 3.0 mm and Ø 4.0 mm

» ¼	Description	Order no.	List price EUR
	For measuring range 300 mm, steel, hardened	0250 101	5.70
	For measuring range 500 + 600 mm, steel, hardened	0250 102	11.40
	For measuring range 800 + 1000 mm, steel, hardened	0250 103	15.60
	For measuring range 300 mm, carbide	0250 201	57.00
	For measuring range 500 + 600 mm, carbide	0250 202	82.00



HELIOS · PREISSER

0262 Caliper for external locking grooves

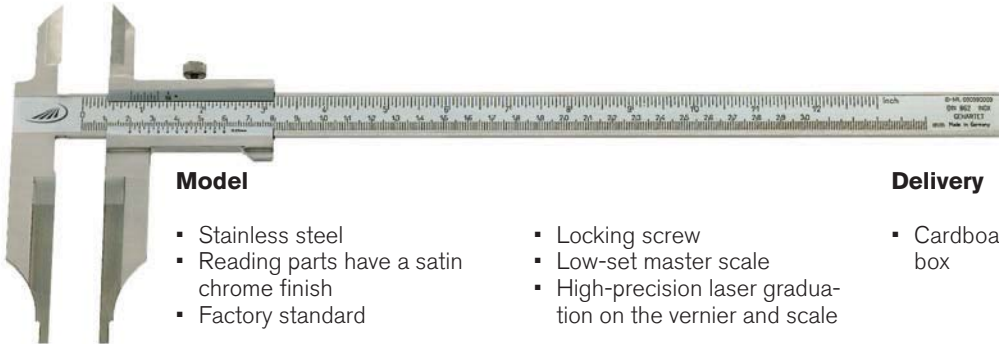

Model

- Stainless steel
- Reading parts have a satin chrome finish
- Factory standard
- Locking screw
- Low-set master scale
- High-precision laser graduation on the vernier and scale

Delivery

- Cardboard box

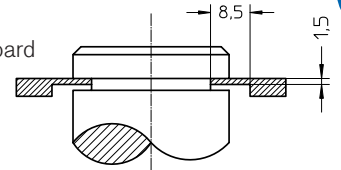

✕	Measuring range		Jaw length		Reading		Error limit	Order no.	List price
	mm	inch	mm	inch	mm	inch			
	0 - 300	0 - 12	90	3.5	0.05	1/128	0.03	0262 503	EUR 260.00

1353 DIGI-MET® Caliper for external locking grooves

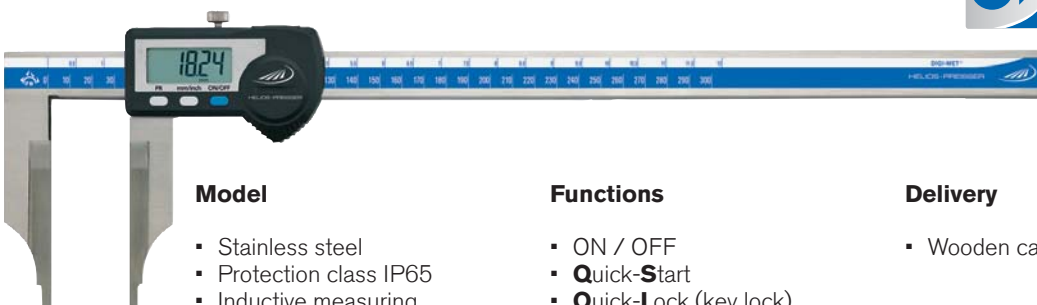

Model

- Stainless steel
- Protection class IP65
- Inductive measuring system
- LCD display 10 mm
- Locking screw
- Factory standard

Functions

- ON / OFF
- Quick-Start
- Quick-Lock (key lock)
- Set to zero at any point
- mm / inch switching
- PRESET-Function (setting a numerical value)
- Variable data output RS 232 + Digimatic + USB

Delivery

- Wooden case

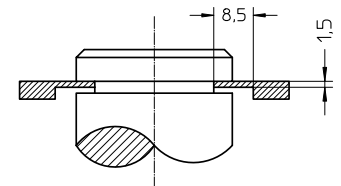

✕	Measuring range		Jaw length		Reading		Error limit	Order no.	List price
	mm	inch	mm	inch	mm	inch			
	0 - 300	0 - 12	90	3.5	0.01	.0005	0.03	1353 522	EUR 471.00



1998720 1997501 1998501

Accessories

	Order no.	List price
Battery, 3V-Lithium, CR 2032	0220 704	3.70
Data cable DATA VARIABLE to RS232	1997 501	48.00
Data cable DATA VARIABLE to digimatic	1998 501	61.00
Data cable DATA VARIABLE to USB	1998 720	69.00



0252 Brake drum vernier calipers



Model

- Stainless steel
- Vernier satin chrome finished
- Factory standard
- Locking screw
- Low-set master scale
- High-precision laser graduation on the vernier and scale

Delivery

- Cardboard box

✕	¼	Measuring range		Jaw length mm	Reading mm	Error limit mm	Order no.	List price EUR
		Internal mm	External mm					
		40 - 300	0 - 300	90	0.05	0.1	0252 201	137.00
		50 - 500	0 - 500	150	0.05	0.14	0252 202	264.00
		50 - 600	0 - 600	200	0.05	0.16	0252 203	289.00

0252 Replacement points (pair) for brake drum vernier caliper



✕	¼	Description	Order no.	List price EUR
		For measuring range 300 mm	0252 291	4.20
		For measuring range 500 + 600 mm	0252 293	5.20

0253 Brake disc inspection gauges

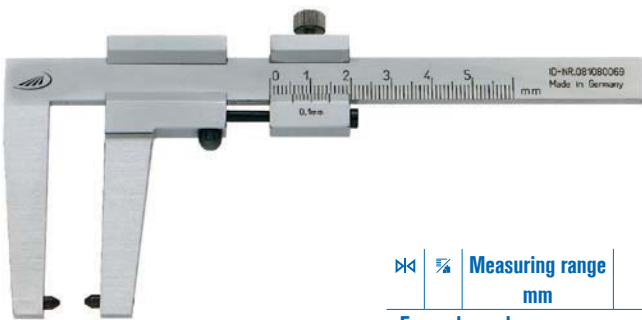

Model

- Special steel
- Reading parts have a satin chrome finish
- Factory standard
- Locking screw
- With trailing vernier
- High-precision laser graduation on the vernier and scale

Delivery

- Cardboard box

✕	¼	Measuring range mm	Jaw length mm	Reading mm	Error limit mm	Order no.	List price EUR
For motorcycles							
		0 - 50	30	0.1	0.1	0253 300	81.00
For cars							
		0 - 50	50	0.1	0.14	0253 301	81.00
For trucks							
		0 - 80	50	0.1	0.16	0253 302	103.00

0253 Replacement points (pair) for brake disc inspection gauge



✕	¼	Order no.	List price EUR
		0253 391	3.70



HELIOS · PREISSER

1352 DIGI-MET® Calipers for interval grooves



Model

- Stainless steel
- LCD display 7.5 mm
- Factory standard
- Locking screw

Functions

- ON / OFF
- **Quick-Start**
- **Quick-Lock** (key lock)
- Set to zero at any point
- mm / inch switching
- PRESET-Function (setting a numerical value)

- Variable data output RS 232 + Digimatic + USB

Delivery

- Wooden case

Measuring range	Jaw length		Reading		Error limit	Order no.	List price
	mm	mm	inch	mm			
10 - 160	25	1.0	0.01	.0005	0.06	1352 516	372.00
20 - 160	40	1.5	0.01	.0005	0.06	1352 517	419.00
26 - 200	60	2.3	0.01	.0005	0.06	1352 518	768.00
30 - 250	80	3.1	0.01	.0005	0.06	1352 520	864.00
35 - 300	100	3.9	0.01	.0005	0.06	1352 522	901.00

0258 Calipers for interval grooves



Model

- Stainless steel
- Reading parts have a satin chrome finish
- Factory standard

Delivery

- Cardboard box

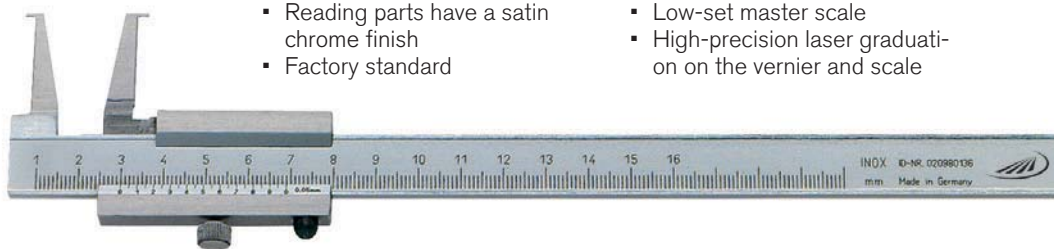

Measuring range	Jaw length		Reading	Error limit	Order no.	List price
	mm	mm				
10 - 160	25	1.0	0.05	0.1	0258 501	138.00
20 - 160	40	1.5	0.05	0.1	0258 502	184.00
26 - 200	60	2.3	0.05	0.1	0258 503	283.00
30 - 250	80	3.1	0.05	0.1	0258 504	320.00
35 - 300	100	3.9	0.05	0.1	0258 505	357.00

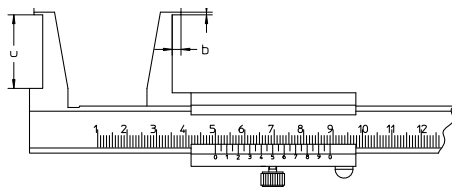

Measuring range	a	b
10 - 160	0.9	3.0
20 - 160	2.0	5.0
26 - 200	3.0	7.0
30 - 250	4.0	8.5
35 - 300	5.0	10.0



0260 Calipers for 3/5 point measurement

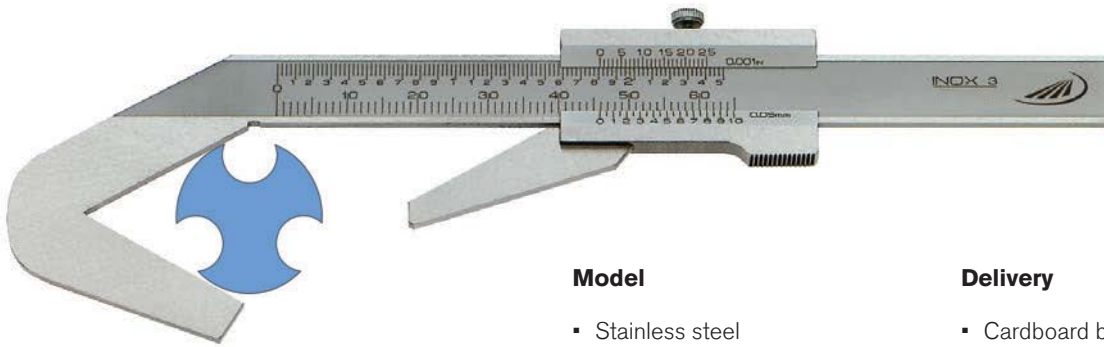

Model

- Stainless steel
- Reading parts have a satin chrome finish
- Locking screw
- Factory standard

Delivery

- Cardboard box

»	¼	Measuring range mm	Reading mm	inch	Error limit mm	Order no.	List price EUR
3 point measurement							
		4 - 40	0.05	1/128	0.05	0260 501	71.00
5 point measurement							
		2 - 40	0.05	1/128	0.05	0260 502	71.00

0268 Milling tool caliper



Model

- Stainless steel
- Vernier satin chrome finished
- Factory standard
- Setting of milling cutters, can be used as height gauge

Delivery

- Cardboard box

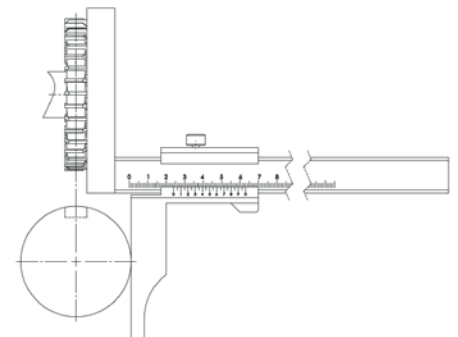

»	¼	Measuring range mm	Jaw length mm	Reading mm	Error limit mm	Order no.	List price EUR
		0 - 200	80	0.05	0.05	0268 518	175.00
		0 - 300	80	0.05	0.05	0268 522	187.00



0597 Chamfer gauge

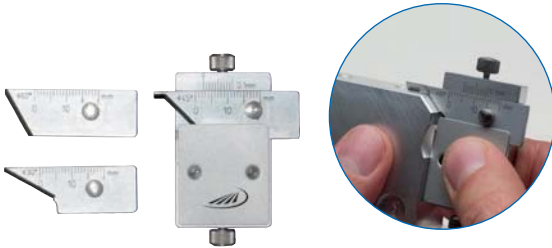

Model

- Stainless steel
- Reading 0.1 mm
- Reading parts are satin chrome finished
- For simultaneously testing of the chamfer angle and the dimensional accuracy
- Dimensions: 48 x 30 x 8.5 mm

Delivery

- 3 interchangeable blades: 30°, 45°, 60°

1

⏏	⚙	Measuring range mm	Reading mm	Order no.	List price EUR
		0 - 10	0.10	0597 301	168.00

0597 Radius gauge



Model

- To determine radius size workpieces
- Stainless steel
- Reading parts are satin chrome finished

Delivery

- Wooden case

⏏	⚙	Measuring range mm	Reading mm	Order no.	List price EUR
		0 - 10	0.10	0597 305	168.00



0268 Gear tooth calipers

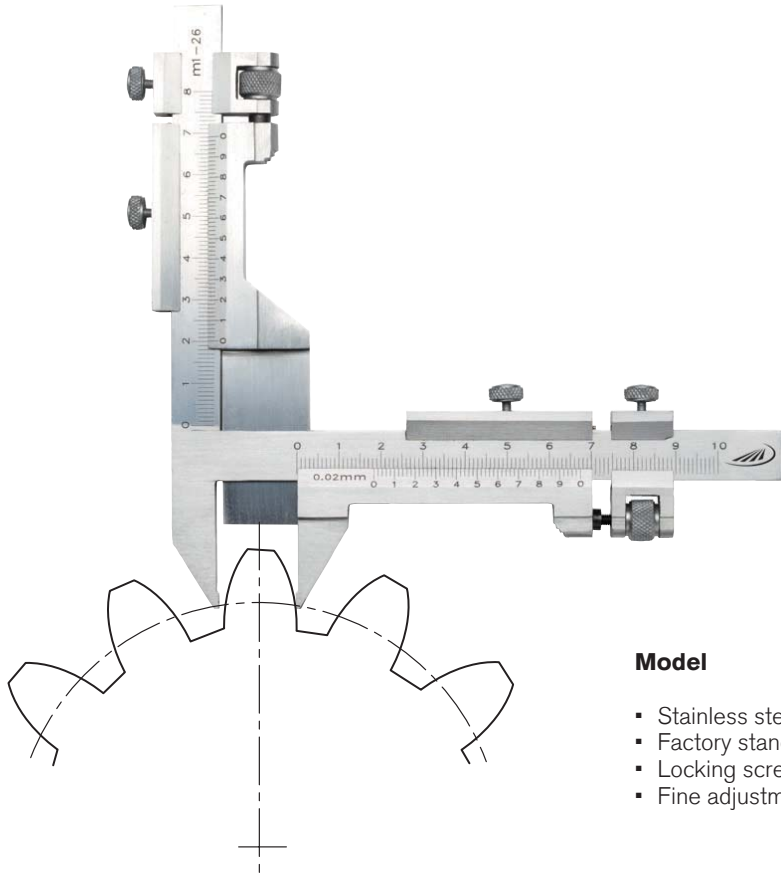

Model

- Stainless steel
- Factory standard
- Locking screw
- Fine adjustment

Delivery

- Wooden case

⌘	⚙	Measuring range mm	Reading mm	Error limit mm	Order no.	List price EUR
Hardened jaw tips						
		0 - 26	0.02	0.1	0268 201	296.00
Carbide tipped jaw tips						
		0 - 26	0.02	0.1	0268 211	361.00



0280 / 0281 Vernier depth gauges



1



0280 501



0281 501

Model

- Stainless steel
- Reading parts have a satin chrome finish
- DIN 862
- Low-set master scale
- Locking screw
- Measuring rod with interchangeable pin
- High-precision laser graduation on the vernier and scale

Delivery

- Cardboard box

»	¼	Measuring range		Base length	Reading	Error limit	Order no.	List price
		mm	inch	mm	mm	mm		EUR
Vernier satin chrome finished. measuring rod with interchangeable pin (factory standard)								
▪		0 - 80		50	0.05	0.05	0280 501	59.00
Vernier satin chrome finished. reversible measuring rod with interchangeable pin								
▪		0 - 150	0 - 6	100	0.05	0.05	0281 201	78.00
▪		0 - 200	0 - 8	100	0.05	0.05	0281 202	81.00
▪		0 - 250	0 - 10	130	0.05	0.05	0281 204	90.00
▪		0 - 300	0 - 12	150	0.05	0.05	0281 205	102.00
Vernier + scale satin chrome finished. reversible measuring rod with interchangeable pin								
▪		0 - 150	0 - 6	100	0.05	0.05	0281 501	85.00
▪		0 - 200	0 - 8	100	0.05	0.05	0281 502	88.00
▪		0 - 250	0 - 10	130	0.05	0.05	0281 504	101.00
▪		0 - 300	0 - 12	150	0.05	0.05	0281 505	110.00

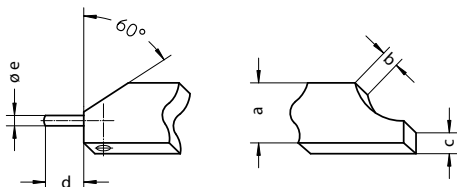

Measuring range	a	b	c	d	e
0 - 80	8.0	3.0	-	6.0	1.0
150 - 200	8.0	3.0	3.5	8.0	1.5
250 - 300	12.0	4.0	4.0	8.0	2.0



0282 Vernier depth gauges



DIN
862

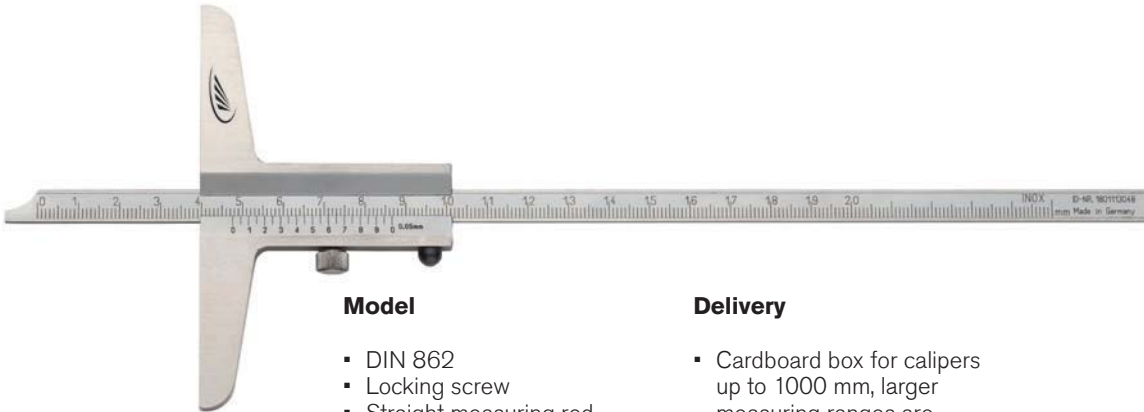

Model

- DIN 862
- Locking screw
- Straight measuring rod
- Low-set master scale
- High-precision laser graduation on the vernier and scale

Delivery

- Cardboard box for calipers up to 1000 mm, larger measuring ranges are individually packed

»	%	Measuring range		Base length mm	Reading mm	Error limit mm	Order no.	List price EUR
		mm	inch					
Stainless steel, vernier satin chrome finished								
▪		0 - 150	0 - 6	100	0.05	0.05	0282 201	69.00
▪		0 - 200	0 - 8	100	0.05	0.05	0282 202	71.00
▪		0 - 300	0 - 12	100	0.05	0.05	0282 203	82.00
▪		0 - 250	0 - 10	130	0.05	0.05	0282 204	79.00
▪		0 - 300	0 - 12	150	0.05	0.05	0282 205	86.00
▪		0 - 400	0 - 16	150	0.05	0.06	0282 206	97.00
▪		0 - 500	0 - 20	150	0.05	0.07	0282 207	133.00
▪		0 - 500	0 - 20	250	0.05	0.07	0282 208	205.00
▪		0 - 800	0 - 31	250	0.05	0.1	0282 209	338.00
▪		0 - 1000	0 - 39	250	0.05	0.12	0282 210	480.00
	▪	0 - 1500	0 - 59	300	0.05	0.18	0282 212	1172.00
	▪	0 - 2000	0 - 79	300	0.05	0.22	0282 213	1540.00
Stainless steel, vernier + scale satin chrome finished								
▪		0 - 150	0 - 6	100	0.05	0.05	0282 501	75.00
▪		0 - 200	0 - 8	100	0.05	0.05	0282 502	79.00
▪		0 - 300	0 - 12	100	0.05	0.05	0282 503	89.00
▪		0 - 250	0 - 10	130	0.05	0.05	0282 504	86.00
▪		0 - 300	0 - 12	150	0.05	0.05	0282 505	95.00
▪		0 - 500	0 - 20	150	0.05	0.07	0282 507	146.00
▪		0 - 500	0 - 20	250	0.05	0.07	0282 508	223.00
▪		0 - 800	0 - 31	250	0.05	0.1	0282 509	371.00
▪		0 - 1000	0 - 39	250	0.05	0.12	0282 510	526.00

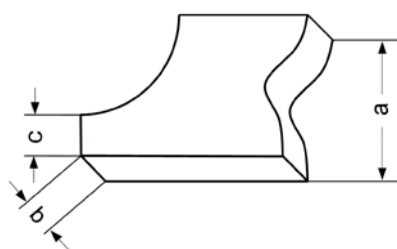

Measuring range mm	a	b	c
150 - 200	8.0	3.0	3.5
250 - 500	12.0	4.0	4.0
500 - 1000	20.0	5.0	10.0
1500	25.0	6.0	13.0
2000	30.0	7.0	13.0



0286 Vernier depth gauges



**DIN
862**

1



Reversible measuring rod

Model

- DIN 862
- Locking screw
- Reversible, L shaped measuring rod
- Scales on both sides
- Low-set master scale

Delivery

- High-precision laser graduation on the vernier and scale
- Cardboard box for calipers up to 1000 mm, larger measuring ranges are individually packed

»	%	Measuring range		Base length mm	Reading mm	Error limit mm	Order no.	List price EUR
		mm	inch					
Stainless steel, vernier satin chrome finished								
▪		0 - 150	0 - 6	100	0.05	0.05	0286 201	82.00
▪		0 - 200	0 - 8	100	0.05	0.05	0286 202	84.00
▪		0 - 250	0 - 10	130	0.05	0.05	0286 204	95.00
▪		0 - 300	0 - 12	150	0.05	0.05	0286 205	102.00
▪		0 - 400	0 - 16	150	0.05	0.06	0286 206	126.00
▪		0 - 500	0 - 20	150	0.05	0.07	0286 207	160.00
▪		0 - 500	0 - 20	250	0.05	0.07	0286 208	268.00
▪		0 - 800	0 - 31	250	0.05	0.1	0286 209	420.00
▪		0 - 1000	0 - 39	250	0.05	0.12	0286 210	583.00
	▪	0 - 1500	0 - 59	300	0.05	0.18	0286 212	1259.00
	▪	0 - 2000	0 - 79	300	0.05	0.22	0286 213	1623.00
Stainless steel, vernier + scale satin chrome finished								
▪		0 - 150	0 - 6	100	0.05	0.05	0286 501	89.00
▪		0 - 200	0 - 8	100	0.05	0.05	0286 502	90.00
▪		0 - 250	0 - 10	130	0.05	0.05	0286 504	104.00
▪		0 - 300	0 - 12	150	0.05	0.05	0286 505	110.00
▪		0 - 500	0 - 20	150	0.05	0.07	0286 507	177.00
▪		0 - 500	0 - 20	250	0.05	0.07	0286 508	372.00
▪		0 - 800	0 - 31	250	0.05	0.1	0286 509	502.00
▪		0 - 1000	0 - 39	250	0.05	0.12	0286 510	639.00

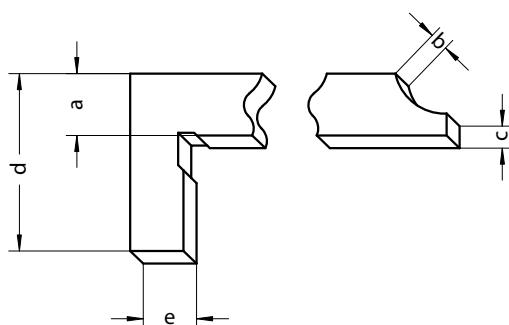

Measuring range mm	a	b	c	d	e
150 - 200	8.0	3.0	3.5	20.0	5.0
250 - 500	12.0	4.0	4.0	28	10
500 - 1000	20.0	5.0	10.0	70.0	19.0
1500	25.0	6.0	13.0	90.0	24.0
2000	30.0	7.0	13.0	90.0	29.0



0292 Offset vernier depth gauges

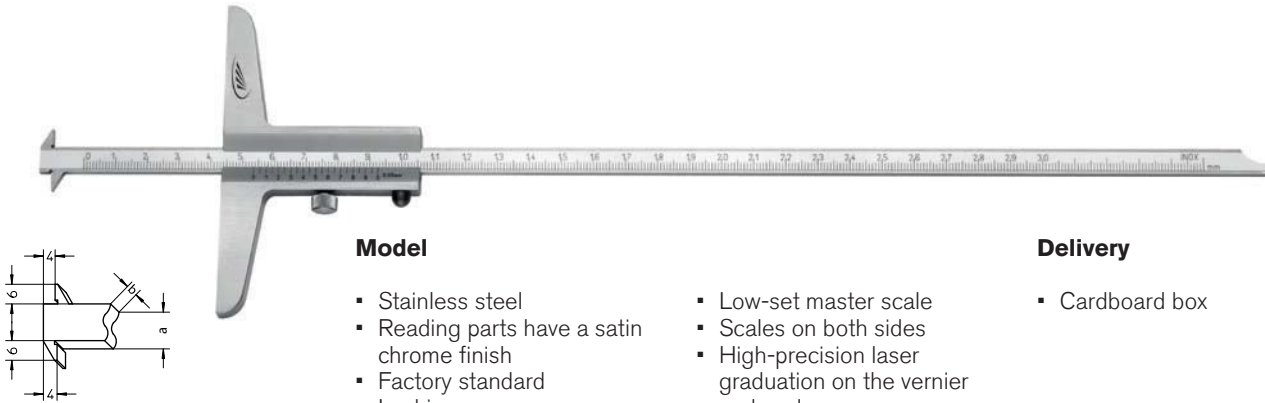

Model

- Stainless steel
- Reading parts have a satin chrome finish
- Factory standard
- Locking screw
- Reversible, offset meas. rod
- Low-set master scale
- Scales on both sides
- High-precision laser graduation on the vernier and scale

Delivery

- Cardboard box

✕	%	Measuring range		Base length mm	Reading mm	Error limit mm	Order no.	List price EUR
		mm	inch					
		0 - 200	0 - 8	100	0.05	0.05	0292 501	84.00
		0 - 300	0 - 12	100	0.05	0.05	0292 502	96.00

0294 Vernier depth gauges with sliding measuring base

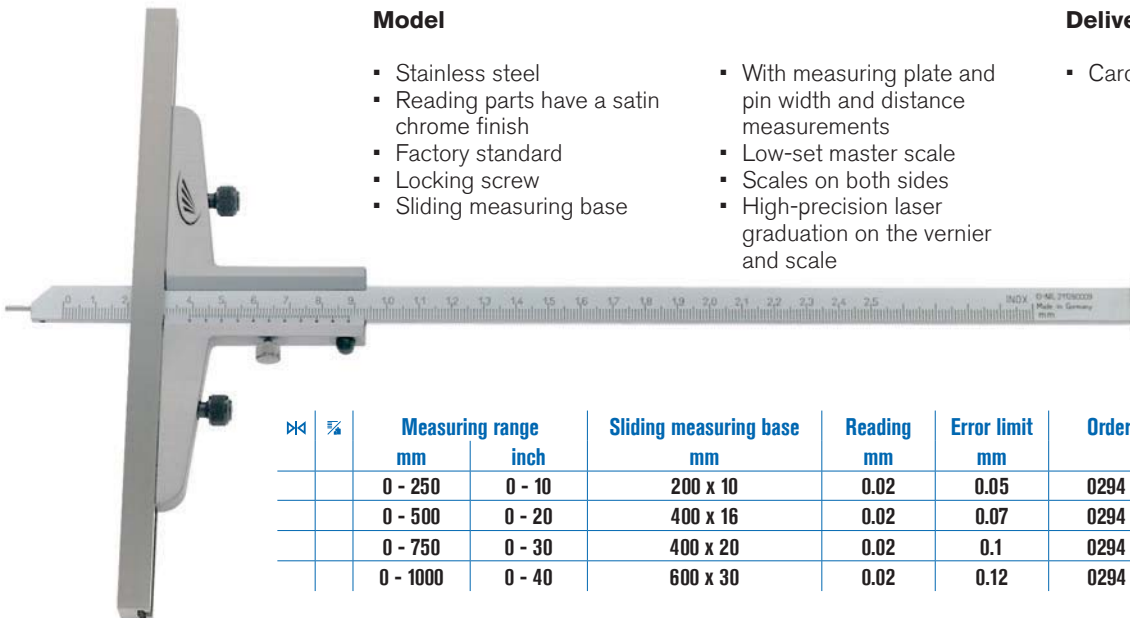

Model

- Stainless steel
- Reading parts have a satin chrome finish
- Factory standard
- Locking screw
- Sliding measuring base
- With measuring plate and pin width and distance measurements
- Low-set master scale
- Scales on both sides
- High-precision laser graduation on the vernier and scale

Delivery

- Cardboard box

✕	%	Measuring range		Sliding measuring base mm	Reading mm	Error limit mm	Order no.	List price EUR
		mm	inch					
		0 - 250	0 - 10	200 x 10	0.02	0.05	0294 504	451.00
		0 - 500	0 - 20	400 x 16	0.02	0.07	0294 505	720.00
		0 - 750	0 - 30	400 x 20	0.02	0.1	0294 506	1119.00
		0 - 1000	0 - 40	600 x 30	0.02	0.12	0294 507	1517.00

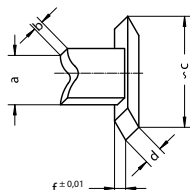
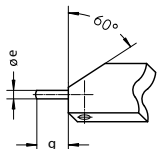

Measuring range mm	a	b	c	d	e	f	g
250 - 500	12.0	4.0	18.0	6.0	2.0	2.0	8.0
750 - 1000	20.0	5.0	30.0	8.0	3.0	3.0	8.0



1360 DIGI-MET® Depth gauges

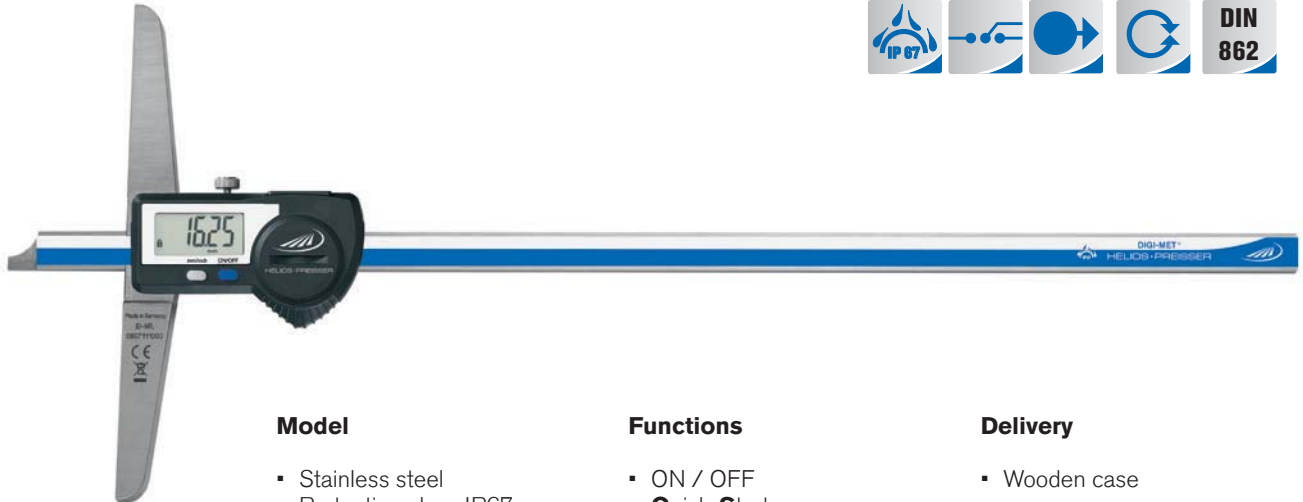

Model

- Stainless steel
- Protection class IP67
- LCD display 7.5 mm
- DIN 862
- Locking screw
- Straight measuring rod

Functions

- ON / OFF
- **Quick-Start**
- **Quick-Lock** (key lock)
- Set to zero at any point
- mm / inch switchin
- Variable data output RS 232 + Digimatic + USB

Delivery

- Wooden case

▶	Measuring range		Base length mm	Reading		Error limit mm	Order no.	List price EUR
	mm	inch		mm	inch			
▪	0 - 150	0 - 6	100	0.01	.0005	0.03	1360 716	316.00
▪	0 - 200	0 - 8	100	0.01	.0005	0.03	1360 718	358.00
▪	0 - 300	0 - 12	150	0.01	.0005	0.03	1360 722	402.00
▪	0 - 500	0 - 20	150	0.01	.0005	0.03	1360 728	462.00
▪	0 - 1000	0 - 39	250	0.01	.0005	0.04	1360 734	1315.00
▪	0 - 1500	0 - 59	250	0.01	.0005	0.05	1360 738	2006.00
▪	0 - 2000	0 - 80	250	0.01	.0005	0.06	1360 740	2381.00



Accessories

	Order no.	List price EUR
Battery, 3V-Lithium, CR 2032	0220 704	3.70
Data cable DATA VARIABLE to RS232	1997 501	48.00
Data cable DATA VARIABLE to digimatic	1998 501	61.00
Data cable DATA VARIABLE to USB	1998 720	69.00



1362 DIGI-MET® Depth gauges

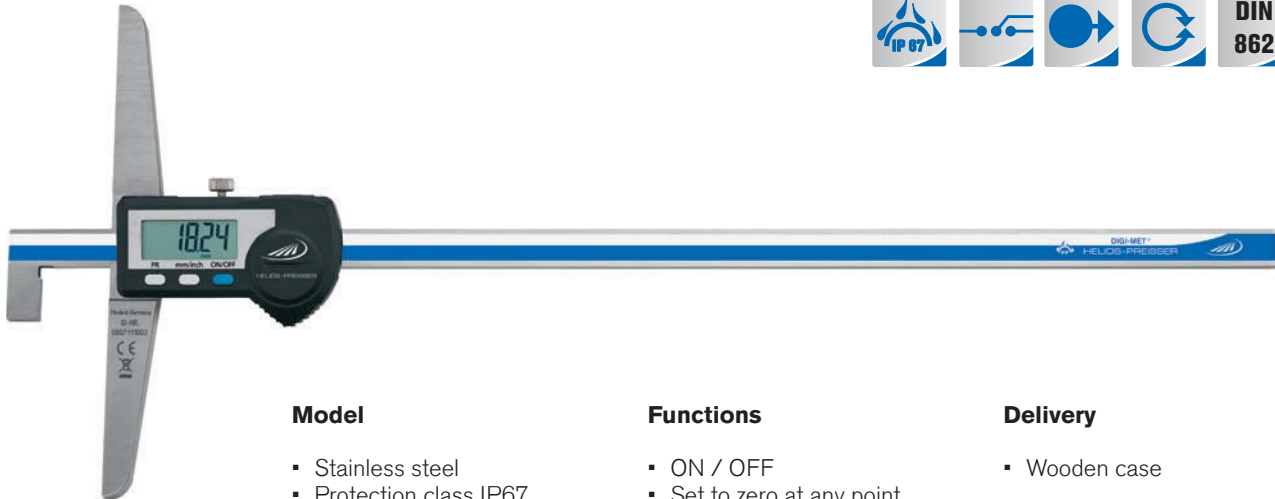

Model

- Stainless steel
- Protection class IP67
- LCD display 7,5 mm
- Locking screw
- L-shaped measuring rod
- Larger measuring ranges are available upon request
- Factory standard

Functions

- ON / OFF
- Set to zero at any point
- mm / inch switching
- **Quick-Start**
- **Quick-Lock** (key lock)
- PRESET-Function (setting a numerical value)
- Variable data output RS 232 + Digimatic + USB

Delivery

- Wooden case

Marked	Measuring range		Base length	Reading		Error limit	Order no.	List price
	mm	inch		mm	inch			
▪	0 - 300	0 - 12	150	0.01	.0005	0.03	1362 722	412.00
▪	0 - 500	0 - 20	150	0.01	.0005	0.03	1362 728	479.00



1998720

1997501

1998501

Accessories

	Order no.	List price
Battery, 3V-Lithium, CR 2032	0220 704	3.70
Data cable DATA VARIABLE to RS232	1997 501	48.00
Data cable DATA VARIABLE to digimatic	1998 501	61.00
Data cable DATA VARIABLE to USB	1998 720	69.00



1364 DIGI-MET® Depth gauges

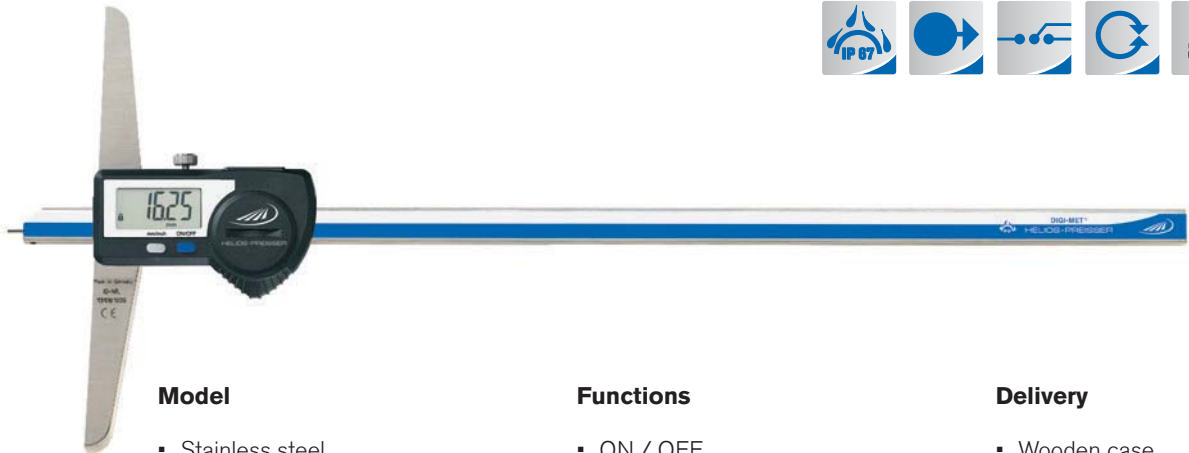

1

Model

- Stainless steel
- Protection class IP67
- LCD display 7.5 mm
- DIN 862
- Locking screw
- Replaceable pin
- Larger measuring ranges are available upon request

Functions

- ON / OFF
- **Quick-Start**
- **Quick-Lock** (key lock)
- Set to zero at any point
- mm / inch switching
- Variable data output RS 232 + Digimatic + USB

Delivery

- Wooden case

▣	Measuring range		Base length mm	Reading		Error limit mm	Order no.	List price EUR
	mm	inch		mm	inch			
▪	0 - 200	0 - 8	100	0.01	.0005	0.03	1364 722	390.00
▪	0 - 300	0 - 12	150	0.01	.0005	0.03	1364 728	434.00

Accessories



1998720

1997501

1998501

	Order no.	List price EUR
Battery, 3V-Lithium, CR 2032	0220 704	3.70
Data cable DATA VARIABLE to RS232	1997 501	48.00
Data cable DATA VARIABLE to digimatic	1998 501	61.00
Data cable DATA VARIABLE to USB	1998 720	69.00

0276 Replacement measuring pin



▣	▣	Diameter mm	Order no.	List price EUR
		2	0276 711	6.10



1366 DIGI-MET® Offset depth gauges

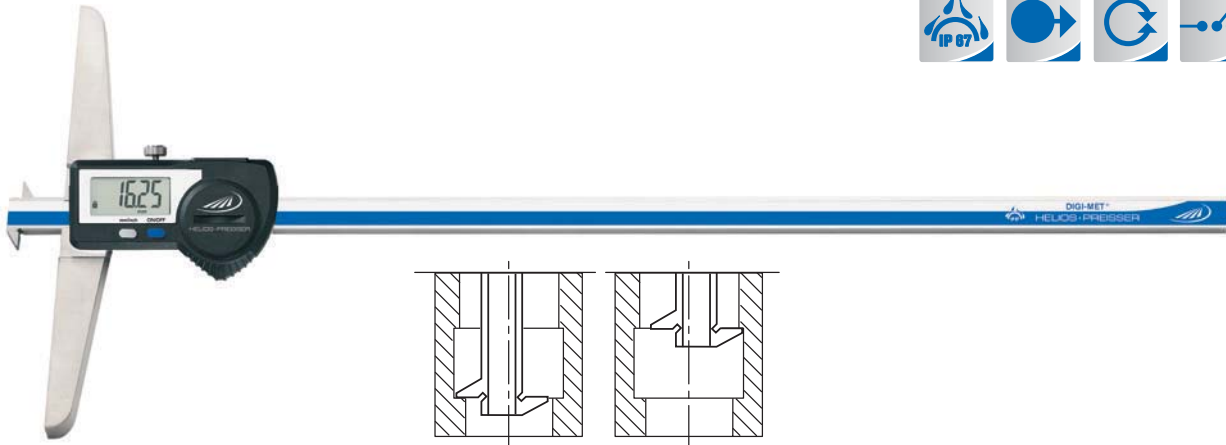

Model

- Stainless steel
- Inductive measuring system, protection class IP67
- LCD display 7,5 mm
- Factory standard
- Housing and operating keys have an excellent chemical resistance
- Locking screw

Functions

- ON / OFF
- **Quick-Start**
- **Quick-Lock** (key lock)
- Set to zero at any point
- mm / inch switching
- Variable data output RS 232 + Digimatic + USB

Delivery

- Wooden case

Marked *	Measuring range		Base length	Reading		Error limit	Order no.	List price
	mm	inch		mm	inch			
▪	0 - 200	0 - 8	100	0.01	.0005	0.03	1366 718	405.00
▪	0 - 300	0 - 12	150	0.01	.0005	0.03	1366 722	489.00
▪	0 - 500	0 - 20	150	0.01	.0005	0.03	1366 728	616.00



1998720

1997501

1998501

Accessories

Battery, 3V-Lithium, CR 2032

Data cable DATA VARIABLE to RS232

Data cable DATA VARIABLE to digimatic

Data cable DATA VARIABLE to USB

Order no.

0220 704

1997 501

1998 501

1998 720

List price

EUR

3.70

48.00

61.00

69.00



1368 DIGI-MET® Depth gauges

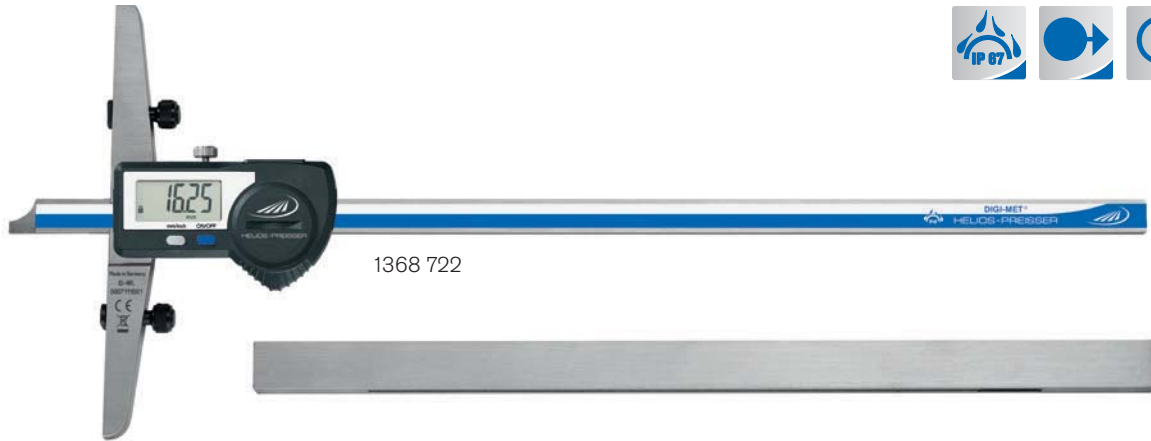

1

Model

- Stainless steel
- Inductive measuring system, protection class IP67
- LCD display 7.5 mm
- Locking screw

Functions

- ON / OFF
- **Quick-Start**
- **Quick-Lock** (key lock)
- Set to zero at any point
- mm / inch switching
- Variable data output RS 232 + Digimatic + USB

Delivery

- Wooden box
- **The sliding measuring base must be ordered separately**

⌂	Measuring range		Base length mm	Reading		Error limit mm	Order no.	List price EUR
	mm	inch		mm	inch			
	0 - 300	0 - 12	150	0.01	.0005	0.03	1368 722	412.00
	0 - 500	0 - 20	150	0.01	.0005	0.03	1368 728	469.00



1998720 1997501 1998501

Accessories

	Order no.	List price EUR
Battery, 3V-Lithium, CR 2032	0220 704	3.70
Data cable DATA VARIABLE to RS232	1997 501	48.00
Data cable DATA VARIABLE to digimatic	1998 501	61.00
Data cable DATA VARIABLE to USB	1998 720	69.00

0279 Sliding measuring base made of stainless steel



0279 722

⌂	Description	Order no.	List price EUR
	300 mm x 16 mm	0279 722	261.00
	400 mm x 16 mm	0279 723	273.00



1371i DIGI-MET® Depth gauges IP67 with integrated wireless



NOVELTY
Data transmission without cable
or radio module

**integrated
IW wireless**



137141 660

Model

- Stainless steel
- Inductive measuring system, protection class IP67
- DIN 862
- Locking screw
- LCD display 11 mm
- Measuring pin dia. 1.5 mm

Functions

- ON / OFF
- **Quick-Start**
- **Quick-Lock** (key lock)
- PRESET-Function (setting a numerical value)
- Set to zero at any point
- mm / inch switching
- Integrated Wireless

Delivery

- Plastic case

✕	🏠	Measuring range		Base length mm	Reading		Error limit mm	Order no.	List price EUR
		mm	inch		mm	inch			
▪		0 - 150	0 - 6	100	0.01	.0005	0.03	137141 660	432.00
▪		0 - 200	0 - 8	100	0.01	.0005	0.03	137141 860	459.00
▪		0 - 300	0 - 12	150	0.01	.0005	0.04	137142 260	516.00
▪		0 - 500	0 - 20	150	0.01	.0005	0.05	137142 860	585.00



1998780

Accessories

Battery, 3V-Lithium, CR 2032
i-Stick USB-receiver for Integrated Wireless

Order no.

0220 704
1998 780

List price EUR

3.70
97.00

Integrated Wireless is intended to be sold in the EU only



1371 DIGI-MET® Depth gauges IP67



1

Model

- Stainless steel
- Inductive measuring system, protection class IP67
- DIN 862
- Locking screw
- LCD display 11 mm
- Measuring pin dia. 1.5 mm

Functions

- ON / OFF
- **Quick-Start**
- **Quick-Lock** (key lock)
- PRESET-Function (setting a numerical value)
- Set to zero at any point
- mm / inch switching

Delivery

- Plastic case



Product video

Measuring range	Measuring range		Base length	Reading		Error limit	Order no.	List price
	mm	inch		mm	mm			
▪	0 - 150	0 - 6	100	0.01	.0005	0.03	1371 416	372.00
▪	0 - 200	0 - 8	100	0.01	.0005	0.03	1371 418	409.00
▪	0 - 300	0 - 12	150	0.01	.0005	0.04	1371 422	456.00
▪	0 - 500	0 - 20	150	0.01	.0005	0.05	1371 428	525.00

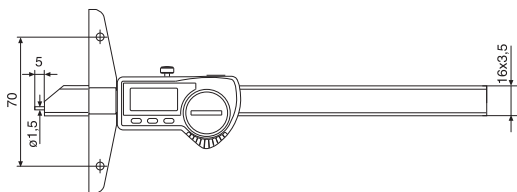

Accessories

Battery, 3V-Lithium, CR 2032

Order no.	List price
0220 704	EUR 3.70

1271 Extension depth attachment base



1271 451

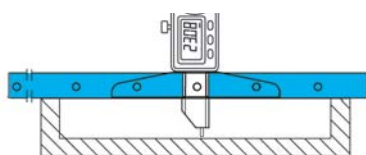

Depth attachment base length mm	Order no.	List price
200	1271 451	EUR 85.00
300	1271 452	EUR 99.00

1271 Measuring insert for distance measurements

Model

- to be attached to the measuring pin

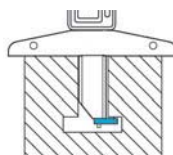

Order no.	List price
1271 455	EUR 57.00



1376 DIGI-MET® Depth gauge



Example of use

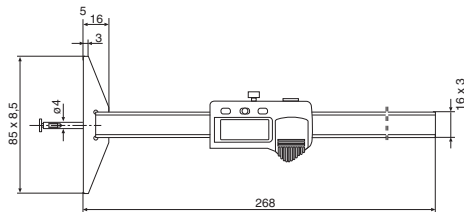
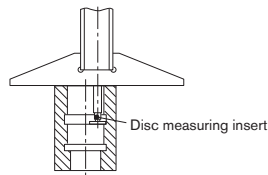
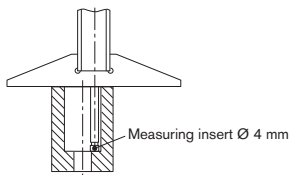

Model

- Stainless steel
- Protection class IP67
- LCD display 7.5 mm
- Locking screw
- Factory standard

Functions

- ON / OFF
- **Quick-Start**
- **Quick-Lock** (key lock)
- Set to zero at any point
- mm / inch switching
- Reversal of counting direction

Delivery

- Wooden case

Marked	Measuring range		Base length	Reading		Error limit	Order no.	List price
	mm	inch		mm	mm			
	0 - 100	0 - 4	85	0.01	.0005	0.02	1376 514	496.00



Accessories

	Order no.	List price
Battery, 3V-Lithium, CR 2032	0220 704	3.70
Disc type measuring insert	1276 591	18.00
Data cable DATA VARIABLE to RS232	1997 501	48.00
Data cable DATA VARIABLE to digimatic	1998 501	61.00
Data cable DATA VARIABLE to USB	1998 720	69.00



1379 DIGI-MET® Depth gauges with interchangeable inserts

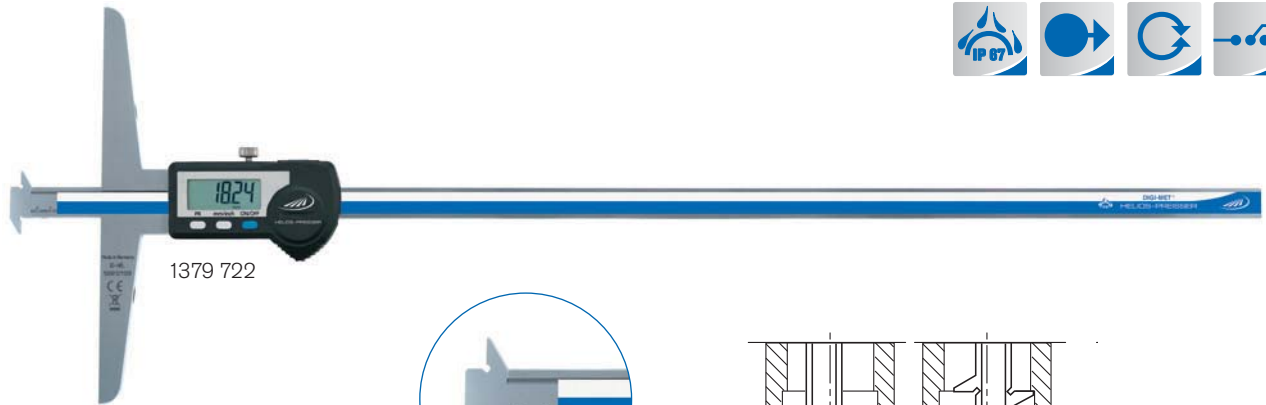

1379 722



1

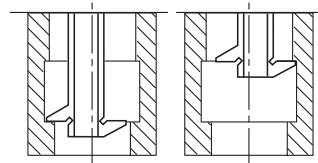
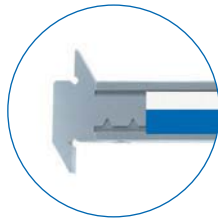

Model

- Interchangeable inserts for solving different measuring tasks
- Measuring base can be attached (optional, see accessories)
- Stainless steel
- Inductive measuring system, protection class IP67
- Factory standard

Functions

- ON / OFF
- **Quick-Start**
- **Quick-Lock** (key lock)
- PRESET-Function (setting a numerical value)
- Set to zero at any point
- mm / inch switching
- Variable data output RS 232 + Digimatic + USB

Delivery

- Wooden case
- With inserts for width and distance measurements, Order no. 1279 780
- [More inserts and measuring base optional](#)

▢	Measuring range		Base length mm	Reading		Error limit mm	Order no.	List price EUR
	mm	inch		mm	inch			
▪	0 - 300	0 - 12	150	0.01	.0005	0.03	1379 722	636.00
▪	0 - 500	0 - 20	150	0.01	.0005	0.03	1379 728	877.00



1998720 1997501 1998501

Accessories

	Order no.	List price EUR
Battery, 3V-Lithium, CR 2032	0220 704	3.70
Data cable DATA VARIABLE to RS232	1997 501	48.00
Data cable DATA VARIABLE to digimatic	1998 501	61.00
Data cable DATA VARIABLE to USB	1998 720	69.00





1279 Interchangeable inserts made of stainless steel, hardened

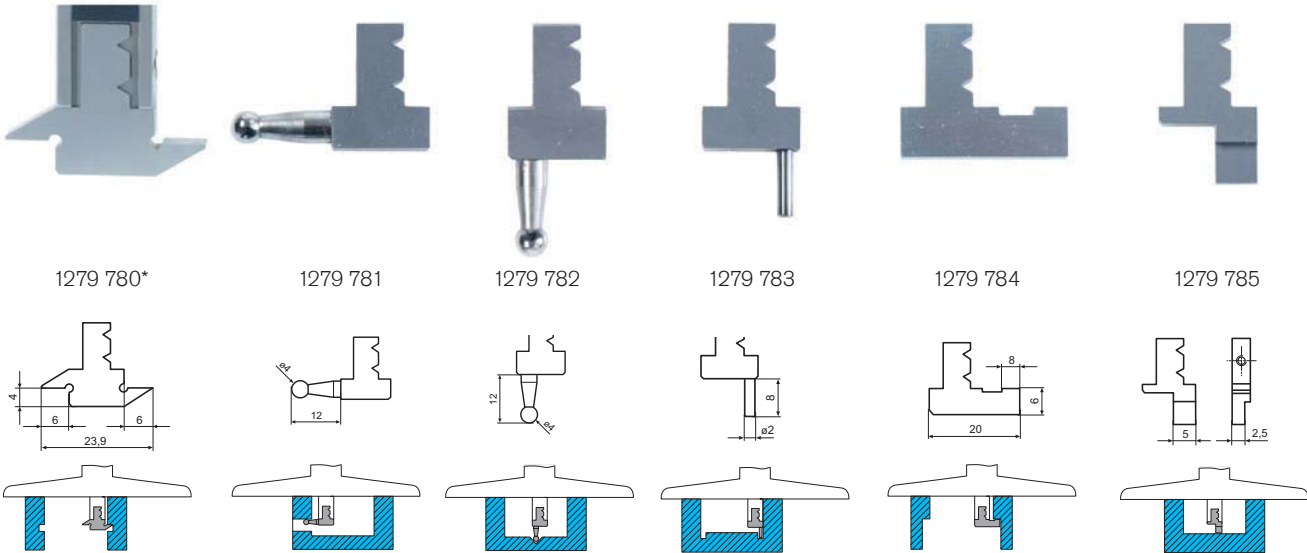

✕	¼	Description	Order no.	List price EUR
		Insert for width and distance measurements*	1279 780	109.00
		Insert with ball, angled	1279 781	109.00
		Insert with ball, straight	1279 782	109.00
		Insert with measuring pin	1279 783	109.00
		Insert with hook	1279 784	109.00
		Insert with straight measuring rod	1279 785	109.00

* Standard insert included in the delivery of the basic instrument

0279 Sliding measuring base made of stainless steel



✕	¼	Description	Order no.	List price EUR
		300 x 16 mm	0279 722	261.00
		400 x 16 mm	0279 723	273.00



1375 DIGI-MET® Small depth gauge



1

Model

- Stainless steel
- Protection class IP67
- LCD display 7.5 mm
- Factory standard
- Measuring pin

Functions

- ON / OFF
- **Quick-Start**
- **Quick-Lock** (key lock)
- Set to zero at any point
- PRESET-Function (setting a numerical value)
- mm / inch switching
- Variable data output RS 232 + Digimatic + USB

Delivery

- Wooden case

Icon	Measuring range		Base length	Reading		Error limit	Order no.	List price
	mm	inch	mm	mm	inch	mm		EUR
	0 - 25	0 - 1	48	0.01	.0005	0.02	1375 502	239.00



1998720 1997501 1998501

Accessories

	Order no.	List price
		EUR
Battery, 3V-Lithium, CR 2032	0220 704	3.70
Data cable DATA VARIABLE to RS232	1997 501	48.00
Data cable DATA VARIABLE to digimatic	1998 501	61.00
Data cable DATA VARIABLE to USB	1998 720	69.00



1378 DIGI-MET® Depth gauges for one-handed operation



Model

- Stainless steel
- Inductive measuring system, protection class IP67
- Locking screw
- Factory standard
- Constant measuring force through spring pressure
- Measuring pin with thread M 2.5 for exchangeable measuring inserts for core hole bores, also compatible with dial gauges inserts (see No. 0710) for depth measurement
- Measuring inserts for core hole bores (for additional costs) see table

Functions

- ON / OFF
- **Quick-Start**
- **Quick-Lock** (key lock)
- Set to zero at any point
- mm / inch switching
- PRESET-Function (setting a numerical value)
- Variable data output RS 232 + Digimatic + USB

Delivery

- Ball measuring insert for depth measurement

Marked *	Marked *	Measuring range		Reading		Error limit mm	Order no.	List price EUR
		mm	inch	mm	inch			
		0 - 60	0 - 2.4	0.01	.0005	0.02	1378 505	756.00
		0 - 100	0 - 4	0.01	.0005	0.02	1378 508	814.00



1278 Measuring inserts

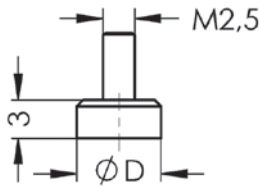

⊕	⊗	Thread size mm	Core diameter mm	Insert diameter mm	Order no.	List price EUR
		M 16 x 1.5	14.38	14.32	1278 923	27.00
		M 16 x 1	14.92	14.87	1278 924	27.00
		M 12 x 1.25	10.65	10.59	1278 936	27.00
		M 12 x 1	10.92	10.87	1278 938	27.00
		M 10 x 1	8.92	8.87	1278 940	27.00
		M 10 x 0.75	9.19	9.13	1278 942	27.00
		M 8 x 1	6.92	6.87	1278 944	27.00
		M 8 x 0.75	7.19	7.14	1278 946	27.00
		M 6 x 0.75	5.19	5.14	1278 948	27.00
		M 5 x 0.5	4.46	4.41	1278 950	27.00
		M 16	13.84	13.79	1278 952	27.00
		M 12	10.11	10.05	1278 954	27.00
		M 10	8.38	8.32	1278 956	27.00
		M 8	6.65	6.59	1278 958	27.00
		M 6	4.92	4.87	1278 960	27.00
		M 5	4.13	4.08	1278 962	27.00
		16 pieces - set			1278 930	396.00

1

1278 Reduction piece

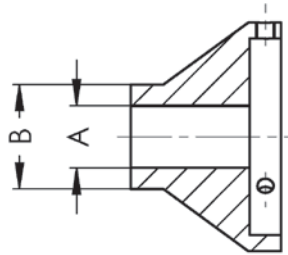

⊕	⊗	A mm	B mm	Order no.	List price EUR
		6	12.00	1278 912	109.00
		9.5	16.00	1278 916	109.00
		15	20.00	1278 920	109.00



0273 DIGI-MET® Mounting scales



0273 732

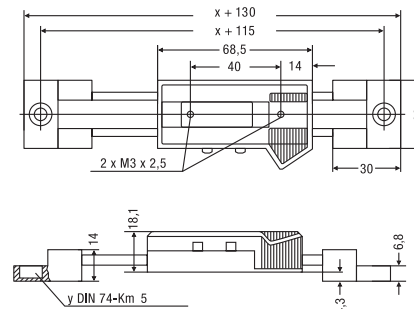
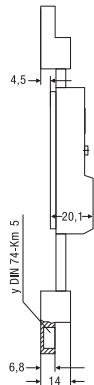
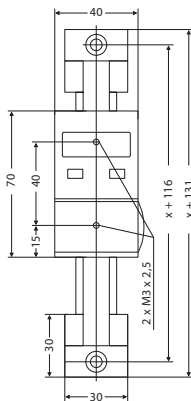

0273 752

Model

- Beam made of stainless steel
- Slide and fixture are made of anodized aluminium
- Larger measuring ranges are available upon request

Functions

- ON / OFF
- Set to zero at any point
- mm / inch switching
- Hold
- PRESET-Function (setting a numerical value)

Delivery

- Cardboard box

⊗	%	Measuring range		Reading		Error limit mm	Order no.	List price EUR
		mm	inch	mm	inch			
Horizontal								
		0 - 150	0 - 6	0.01	.0005	0.03	0273 731	197.00
		0 - 200	0 - 8	0.01	.0005	0.03	0273 732	203.00
		0 - 300	0 - 12	0.01	.0005	0.03	0273 735	220.00
		0 - 450	0 - 18	0.01	.0005	0.03	0273 738	233.00
		0 - 600	0 - 24	0.01	.0005	0.03	0273 741	283.00
		0 - 800	0 - 31	0.01	.0005	0.04	0273 745	495.00
		0 - 1000	0 - 39	0.01	.0005	0.04	0273 746	539.00
Vertical								
		0 - 150	0 - 6	0.01	.0005	0.03	0273 751	353.00
		0 - 200	0 - 8	0.01	.0005	0.03	0273 752	358.00
		0 - 300	0 - 12	0.01	.0005	0.03	0273 755	380.00
		0 - 450	0 - 18	0.01	.0005	0.03	0273 758	400.00
		0 - 600	0 - 24	0.01	.0005	0.03	0273 761	430.00
		0 - 800	0 - 31	0.01	.0005	0.04	0273 765	604.00
		0 - 1000	0 - 39	0.01	.0005	0.04	0273 766	649.00



Accessories

	Order no.	List price EUR
Battery, 3V-Lithium, CR 2032	0220 704	3.70
Data cable opto to RS232	0996 701	74.00
Data cable opto to USB	0996 705	141.00
USB-keyboard interface cable	0997 770	241.00



0003 Wooden case for calipers



1

☒	☒	Measuring range	Jaw length (knife points)	Jaw length (w.o. knife points)	Internal dimensions	Order no.	List price
		mm	mm	mm	L x W x H mm		EUR
		160	40	40	250 x 90 x 20	0003 219	7.40
		200	80	80	315 x 145 x 20	0003 220	8.80
		250	80	80	370 x 145 x 20	0003 221	11.10
		300	90	90	435 x 175 x 20	0003 222	15.40
		300		150	435 x 205 x 20	0003 223	17.20
		400		125	610 x 180 x 20	0003 224	25.90
		400	125	150	590 x 220 x 20	0003 225	33.70
		400	150	200	590 x 250 x 20	0003 226	40.20
		400	200		590 x 300 x 20	0003 227	36.80
		500		150	690 x 200 x 20	0003 228	44.80
		500	150	200	690 x 250 x 25	0003 229	46.00
		500	200	250	700 x 315 x 25	0003 230	47.20
		500	250		700 x 350 x 21	0003 231	48.20
		600		150	790 x 200 x 25	0003 232	48.20
		600	150	200	790 x 250 x 25	0003 233	58.00
		600	200		790 x 315 x 21	0003 234	64.00
		600		300	810 x 400 x 25	0003 235	70.00
		800		150	1000 x 220 x 25	0003 236	59.00
		800	150	200	1000 x 270 x 25	0003 237	63.00
		800	200		1000 x 320 x 21	0003 238	64.00
		800		300	1000 x 380 x 25	0003 239	72.00
		800	300		1000 x 420 x 21	0003 240	83.00
		800		400	1100 x 480 x 25	0003 241	83.00
		1000		150	1200 x 220 x 25	0003 242	79.00
		1000	150	200	1250 x 270 x 25	0003 243	84.00
		1000	200		1200 x 320 x 21	0003 244	95.00
		1000		300	1200 x 380 x 25	0003 245	105.00
		1000	300		1230 x 420 x 21	0003 246	113.00
		1000		500	1300 x 600 x 25	0003 247	130.00
	▪	1250		200	1520 x 310 x 25	0003 248	110.00
	▪	1250	200	300	1520 x 380 x 25	0003 249	110.00
	▪	1250	300		1520 x 440 x 25	0003 250	140.00
	▪	1500		200	1800 x 310 x 25	0003 251	146.00
	▪	1500	200	300	1800 x 380 x 25	0003 252	158.00
	▪	1500	300		1800 x 440 x 25	0003 253	188.00
	▪	2000		200	2300 x 310 x 25	0003 254	245.00
	▪	2000	200	300	2300 x 380 x 25	0003 255	289.00
	▪	2000	300		2300 x 460 x 25	0003 256	273.00
	▪	3000		200	3310 x 310 x 25	0003 257	294.00
	▪	3000	200	300	3310 x 400 x 25	0003 258	305.00
	▪	3000	300		3310 x 460 x 25	0003 259	353.00



SAMPLES MICROMETERS

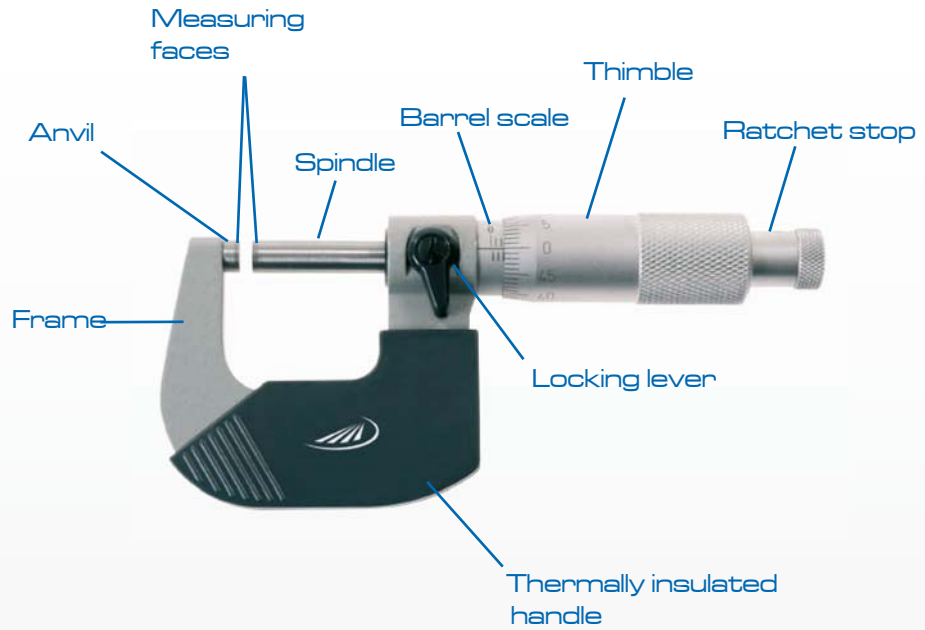

NEW



Micrometer highlights from our assortment



INTERNAL MICROMETERS



SPECIAL MICROMETERS



HOLDER & SETTING STANDARDS

2. CHAPTER MICROMETERS

86	External micrometers
93	Digital external micrometers
98	Precision dial micrometers
99	External micrometers with special measuring faces
101	Setting standards for micrometers
102	External micrometers for thread flank measurement
105	External micrometers for gear tooth measurements
106	Wire micrometer
107	Internal micrometers
111	Digital 2 point internal micrometers
114	Digital internal micrometers / with measuring pistol
118	Measuring heads and extensions
119	Depth micrometers



0800 External micrometers



DIN
863-1

Model

- DIN 863-1
- Reading: 0.01 mm
- Reading parts are satin chrome finished
- Locking lever
- Ratchet stop
- Carbide measuring faces
- Thermally insulated

Delivery

- Plastic case
- From measuring range 25 - 50 mm upwards includes a setting standard

0800 501

✂	⊘	Measuring range mm	Pitch mm	Spindle dia. mm	Thimble dia. mm	Error limit mm	Order no.	List price EUR
		0 - 25	0.5	6.5	17	0.004	0800 501	18.10
		25 - 50	0.5	6.5	17	0.004	0800 502	22.00
		50 - 75	0.5	6.5	17	0.005	0800 503	25.20
		75 - 100	0.5	6.5	17	0.005	0800 504	29.80

0800 Set of external micrometers



Delivery

- Includes 4 external micrometers
- Incl. setting gauges 25/50/75 mm
- Wooden case

DIN
863-1

✂	⊘	Measuring range mm	Pitch mm	Spindle dia. mm	Thimble dia. mm	Order no.	List price EUR
		0 - 100	0.5	6.5	17	0800 513	106.00

0807 Holder for external micrometers



Model

- With heavy cast iron base
- Vertically rotating and lockable

Delivery

- Cardboard box

✂	⊘	Measuring range mm	Order no.	List price EUR
		0 - 300	0807 101	54.00



0806 External micrometers with friction clutch



DIN
863-1



0806 501

Model

- DIN 863-1
- Reading: 0.01 mm
- Reading parts are satin chrome finished
- Locking lever
- With friction clutch (ratchet)
- Fixed quick drive
- Carbide measuring faces
- Thermally insulated

Delivery

- Plastic case
- From measuring range 25 - 50 mm upwards includes a setting gauge

⌘	⌘	Measuring range mm	Pitch mm	Spindle dia. mm	Thimble dia. mm	Error limit mm	Order no.	List price EUR
		0 - 25	0.5	6.5	18	0.004	0806 501	32.70
		25 - 50	0.5	6.5	18	0.004	0806 502	35.80
		50 - 75	0.5	6.5	18	0.005	0806 503	39.00
		75 - 100	0.5	6.5	18	0.005	0806 504	42.10

2

0806 Set of external micrometers with friction clutch



DIN
863-1



0806 513

Delivery

- Includes 4 external micrometers
- Incl. setting gauges 25/50/75 mm
- Wooden case

⌘	⌘	Measuring range mm	Pitch mm	Spindle dia. mm	Thimble dia. mm	Error limit mm	Order no.	List price EUR
		0 - 100	0.5	6.5	18	0.005	0806 513	154.00



0806 External micrometers



DIN
863-1



Model

- DIN 863-1
- Reading 0.01 mm
- Reading parts are satin chrome finished
- Locking lever
- Ratchet stop
- Carbide measuring faces
- Thermally insulated
- Coated steel frame

Delivery

- Plastic case
- From measuring range 25 - 50 mm upwards includes a setting standard

✕	¼	Measuring range mm	Pitch mm	Spindle dia. mm	Thimble dia. mm	Error limit mm	Order no.	List price EUR
		0 - 25	0.5	6.5	17.5	0.004	0806 521	44.80
		25 - 50	0.5	6.5	17.5	0.004	0806 522	71.00
		50 - 75	0.5	6.5	17.5	0.005	0806 523	87.00
		75 - 100	0.5	6.5	17.5	0.005	0806 524	101.00
		100 - 125	0.5	6.5	17.5	0.006	0806 525	137.00
		125 - 150	0.5	6.5	17.5	0.006	0806 526	154.00
		150 - 175	0.5	6.5	17.5	0.007	0806 527	171.00
		175 - 200	0.5	6.5	17.5	0.007	0806 528	188.00

0806 Set of external micrometers



DIN
863-1



Delivery

- Includes 4 external micrometers
- Incl. setting gauges 25 + 75 mm or 125 + 175 mm
- Wooden case

✕	¼	Measuring range mm	Pitch mm	Spindle dia. mm	Thimble dia. mm	Order no.	List price EUR
		0 - 100	0.5	6.5	17.5	0806 540	264.00
		100 - 200	0.5	6.5	17.5	0806 542	581.00



0810 External micrometers



DIN
863-1



0810 504

Model

- DIN 863-1
- Reading: 0.01 mm
- Reading parts are satin chrome finished
- Locking ring
- Spheroid ductile iron frame, lacquered
- Ratchet stop
- Carbide measuring faces
- Thermally insulated

Delivery

- Wooden case

2

⌘	⌘	Measuring range mm	Pitch mm	Spindle dia. mm	Thimble dia. mm	Error limit mm	Order no.	List price EUR
		0 - 25	1	8	30	0.004	0810 501	248.00
		25 - 50	1	8	30	0.004	0810 502	262.00
		50 - 75	1	8	30	0.005	0810 503	275.00
		75 - 100	1	8	30	0.005	0810 504	292.00

0815 External micrometers with deep frame



DIN
863-1



0815 530

Model

- DIN 863-1
- Reading: 0.01 mm
- Reading parts are satin chrome finished
- Steel bracket lacquered
- Ratchet stop
- Carbide measuring faces

Delivery

- Wooden case

⌘	⌘	Measuring range mm	Frame depth mm	Pitch mm	Spindle dia. mm	Thimble dia. mm	Error limit mm	Order no.	List price EUR
		0 - 25	100	1	8	24	0.004	0815 510	261.00
		0 - 25	150	1	6.5	24	0.004	0815 514	275.00
		0 - 25	250	1	6.5	24	0.004	0815 518	344.00
		0 - 50	50	1	8	24	0.004	0815 530	296.00
		0 - 50	100	1	8	24	0.004	0815 534	437.00
		50 - 100	100	1	8	24	0.005	0815 540	483.00



0816 External micrometers large spindle distance 50 mm



**DIN
863-1**



Model

- DIN 863-1
- Direct reading 0.01 mm, without addition because of thread pitch 1 mm
- Reading parts are satin chrome finished

Delivery

- Wooden case

- Locking ring
- Ratchet stop
- Carbide measuring faces
- Thermally insulated
- With 50 mm spindle movement and a wide measuring range
- Spheroid ductile iron frame. lacquered or coated light alloy frame

✂	⚙	Measuring range mm	Pitch mm	Spindle dia. mm	Thimble dia. mm	Error limit mm	Order no.	List price EUR
		0 - 50	1	8	24	0.004	0816 501	312.00
		50 - 100	1	8	24	0.005	0816 502	352.00
		100 - 150	1	8	24	0.006	0816 503	406.00
		150 - 200	1	8	24	0.007	0816 504	464.00
		200 - 250	1	8	24	0.008	0816 505	528.00
		250 - 300	1	8	24	0.009	0816 506	596.00
		300 - 350	1	10	24	0.01	0816 507	842.00
		350 - 400	1	10	24	0.011	0816 508	889.00
		400 - 450	1	10	24	0.012	0816 509	944.00
		450 - 500	1	10	24	0.013	0816 510	1013.00
		500 - 550	1	10	24	0.015	0816 511	1093.00
		550 - 600	1	10	24	0.017	0816 512	1170.00



0817 External micrometers with wide range of applications 100 mm



DIN
863-3



2

Model

- DIN 863-3
- Direct reading 0.01 mm, without addition because of thread pitch 1 mm
- Reading parts are satin chrome finished
- Spindle adjustment 50 mm
- Reversible anvil (screwed) for measuring range extension
- Locking ring
- Ratchet stop
- Carbide measuring faces
- Thermally insulated
- Robust coated light alloy frame

Delivery

- Wooden case

✕	¼	Measuring range mm	Pitch mm	Spindle dia. mm	Thimble dia. mm	Error limit mm	Order no.	List price EUR
		200 - 300	1	10	24	0.006	0817 512	1005.00
		300 - 400	1	10	24	0.007	0817 514	1045.00
		400 - 500	1	10	24	0.008	0817 516	1170.00
		500 - 600	1	10	24	0.009	0817 518	1327.00
		600 - 700	1	10	24	0.009	0817 520	1485.00
	▪	700 - 800	1	10	24	0.009	0817 522	1647.00
	▪	800 - 900	1	10	24	0.01	0817 524	1813.00
	▪	900 - 1000	1	10	24	0.01	0817 526	2006.00
	▪	1000 - 1100	1	10	24	0.011	0817 528	2209.00
	▪	1100 - 1200	1	10	24	0.011	0817 530	2417.00
	▪	1200 - 1300	1	10	24	0.012	0817 532	2645.00
	▪	1300 - 1400	1	10	24	0.012	0817 534	2931.00
	▪	1400 - 1500	1	10	24	0.013	0817 536	3128.00
	▪	1500 - 1600	1	10	24	0.018	0817 538	4898.00
	▪	1600 - 1700	1	10	24	0.019	0817 540	5198.00
	▪	1700 - 1800	1	10	24	0.02	0817 542	5593.00
	▪	1800 - 1900	1	10	24	0.021	0817 544	5925.00
	▪	1900 - 2000	1	10	24	0.022	0817 546	6295.00

0817 Replacement reversible anvil



Model

- Exchangeable for all measuring ranges

✕	¼	Length mm	Order no.	List price EUR
		50	0817 910	157.00



0819 External micrometers with interchangeable inserts

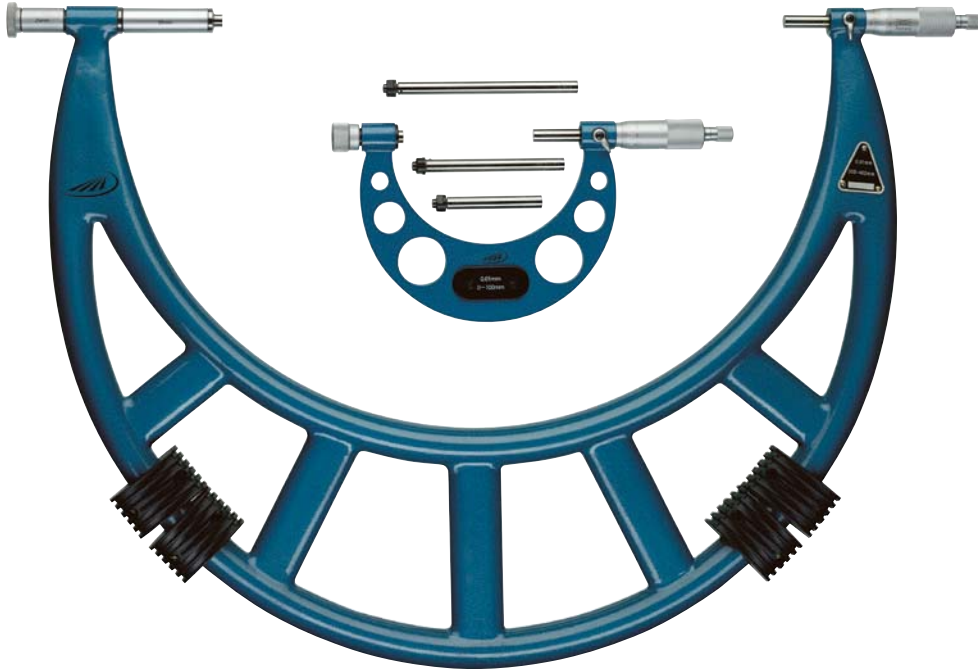

Model

- Reading: 0.01 mm
- Reading parts are satin chrome finished
- Locking lever
- Ratchet stop
- Carbide measuring faces
- Thermally insulated
- Coated malleable cast iron frame* or coated light alloy frame with interchangeable anvil

Delivery

- Wooden case
- Includes setting standards

✕	¼	Measuring range mm	Pitch mm	Spindle dia. mm	Thimble dia. mm	Order no.	List price EUR
		0 - 100	0.5	8	20	0819 501	177.00
		0 - 150	0.5	8	20	0819 502	197.00
		100 - 200	0.5	8	20	0819 503	218.00
		150 - 300	0.5	8	20	0819 505	249.00
		200 - 300	0.5	8	20	0819 510	239.00
		300 - 400	0.5	8	24	0819 511	301.00
		400 - 500	0.5	8	24	0819 512	343.00
		500 - 600	0.5	8	24	0819 513	395.00
		600 - 700	0.5	8	24	0819 514	488.00
	▪	700 - 800	0.5	8	24	0819 515	561.00
	▪	800 - 900	0.5	8	24	0819 516	644.00
	▪	900 - 1000	0.5	8	24	0819 517	727.00
	▪	1000 - 1200	1	8	30	0819 519	1351.00
	▪	1200 - 1400	1	8	30	0819 521	1455.00
	▪	1400 - 1600	1	8	30	0819 523	1714.00
	▪	1600 - 1800	1	8	30	0819 525	1969.00
	▪	1800 - 2000	1	8	30	0819 527	2265.00



0912 Digital micrometers



Model

- Protection class IP54
- Reading: 0.0001 mm / .00005 inch
- Locking lever
- Ratchet stop
- Carbide measuring faces
- Thermally insulated
- Factory standard

Functions

- ON / OFF
- mm / inch switching
- Set to zero at any point

Delivery

- Plastic case
- From measuring range 25 mm upwards includes a setting standard

Icon	Measuring range		Pitch	Spindle dia.	Error limit	Order no.	List price
	mm	inch					
	0 - 25	0 - 1	0.5	6.5	0.006	0912 501	78.00
	25 - 50	1 - 2	0.5	6.5	0.006	0912 502	88.00
	50 - 75	2 - 3	0.5	6.5	0.007	0912 503	101.00
	75 - 100	3 - 4	0.5	6.5	0.007	0912 504	115.00
	100 - 125	4 - 5	0.5	6.5	0.008	0912 505	127.00
	125 - 150	5 - 6	0.5	6.5	0.008	0912 506	139.00
	150 - 175	6 - 7	0.5	6.5	0.009	0912 507	150.00
	175 - 200	7 - 8	0.5	6.5	0.009	0912 508	161.00

Accessories	Order no.	List price
		EUR
Battery 1.5V, type 357	0220 204	3.20

0912 Set of digital micrometers



Delivery

- Includes 4 micrometers
- Incl. setting gauges 25/50/75 mm
- Wooden case

Icon	Measuring range	Pitch	Spindle dia.	Order no.	List price
	mm	mm	mm		EUR
	0 - 100	0.5	6.5	0912 521	417.00



1866 Digital micrometers IP65



NEW

Model

- Reading: 0.001 mm / .00005 inch
- Protection class IP65
- LCD display: 10 mm
- Rapid drive
- Carbide measuring faces
- Spindle stainless, hardened and smoothed
- Frame lacquered
- Thermally insulated
- Factory standard

Functions

- ON / OFF
- **Quick-Start**
- **Quick-Lock** (key lock)
- Set to zero at any point
- mm / inch switching
- ABS (display can be set to zero without losing the Preset value)
- Hold
- ORIGIN (Preset value)

Delivery

- Plastic case
- from measuring range 25 mm upwards includes a setting standard

✂	Measuring range		Pitch mm	Spindle dia. mm	Thimble dia. mm	Error limit mm	Order no.	List price EUR
	mm	inch						
	0 - 25	0 - 1	0.5	6.5	21	0.002	1866 410	199.00
	25 - 50	1 - 2	0.5	6.5	21	0.002	1866 413	259.00
	50 - 75	2 - 3	0.5	6.5	21	0.003	1866 417	329.00
	75 - 100	3 - 4	0.5	6.5	21	0.003	1866 420	375.00

Accessories

Battery, 3V-Lithium, CR 2032

Order no.

0220 704

List price

EUR

3.70



HELIOS • PREISSER

1866i Digital micrometers IP65 with integrated wireless



NOVELTY
Data transmission without cable
or radio module

**integrated
IW wireless**

2



186641 060

Model

- Reading: 0.001 mm / .00005 inch
- Protection class IP65
- LCD display: 10 mm
- Rapid drive
- Carbide measuring faces
- Spindle stainless, hardened and smoothed
- Frame lacquered
- Thermally insulated
- Factory standard

Functions

- ON / OFF
- **Quick-Start**
- **Quick-Lock** (key lock)
- Set to zero at any point
- mm / inch switching
- ABS (display can be set to zero without losing the Preset value)
- Hold
- ORIGIN (Preset value)
- TOL (tolerance value input)
- Integrated Wireless

Delivery

- Plastic case
- From measuring range 25 mm upwards includes a setting standard

Measuring range	Pitch		Spindle dia.	Thimble dia.	Error limit	Order no.	List price
	mm	inch					
0 - 25	0 - 1	0.5	6.5	21	0.002	186641 060	259.00
25 - 50	1 - 2	0.5	6.5	21	0.002	186641 360	319.00
50 - 75	2 - 3	0.5	6.5	21	0.003	186641 760	389.00
75 - 100	3 - 4	0.5	6.5	21	0.003	186642 060	435.00



1998780

Accessories

	Order no.	List price
		EUR
Battery, 3V-Lithium, CR 2032	0220 704	3.70
i-Stick USB-receiver for Integrated Wireless	1998 780	97.00

Integrated Wireless is intended to be sold in the EU only



NEW

1866i Set of digital micrometers with integrated wireless



Delivery

- Plastic case
- from measuring range 25 mm upwards includes a setting standard

Marked *	Measuring range		Pitch mm	Spindle dia. mm	Order no.	List price EUR
	mm	inch				
	0 - 100	0 - 4	0.5	6.5	186642 160	1390.00

1866 Digital micrometer BASIC



Model

- Reading: 0.001 mm / .00005 inch
- Protection class IP40
- LCD display: 10 mm
- Rapid drive
- Carbide measuring faces
- Spindle stainless, hardened and smoothed
- Frame lacquered
- Thermally insulated
- Factory standard

Functions

- ON / OFF
- **Quick-Start**
- **Quick-Lock** (key lock)
- Set to zero at any point
- mm / inch switching
- Hold

Delivery

- Plastic case

Marked *	Measuring range		Pitch mm	Spindle dia. mm	Thimble dia. mm	Error limit mm	Order no.	List price EUR
	mm	inch						
	0 - 25	0 - 1	0.5	6.5	21	0.002	1866 210	169.00

Accessories

Battery, 3V-Lithium, CR 2032

Order no.

0220 704

List price

EUR

3.70



0932 DIGI-MET® External micrometers



0932 701



0932 731

2

Model

- Factory standard
- Selectable resolution 0.01 mm / 0.001 mm; 0.0005 inch / 0.00005 inch
- LCD display 6 mm
- Positive counting direction
- Non-rotating spindle
- Linear measuring system
- Locking lever*
- Carbide measuring faces dia. 8 mm
- Thermally insulated
- Ratchet stop

Functions

- ON / OFF
- Set to zero at any point
- mm / inch switching
- MIN / MAX
- TOL (tolerance value input)
- Hold
- PRESET-Function (setting a numerical value)
- Data output Opto RS 232

Delivery

- Wooden case

»	%	Measuring range		Pitch mm	Spindle dia. mm	Order no.	List price EUR
		mm	inch				
		0 - 25	0 - 1	1	8	0932 701	473.00
		25 - 50	1 - 2	1	8	0932 702	551.00
		50 - 75	2 - 3	1	8	0932 703	623.00
		75 - 100	3 - 4	1	8	0932 704	675.00
		100 - 125	4 - 5	1	8	0932 705	727.00
		125 - 150	5 - 6	1	8	0932 706	779.00
		150 - 175	6 - 7	1	8	0932 707	831.00
		175 - 200	7 - 8	1	8	0932 708	935.00
With lifter - retraction stroke 1.5 mm (without locking lever*)							
		0 - 25	0 - 1	1	8	0932 731	603.00
		25 - 50	1 - 2	1	8	0932 732	623.00
		50 - 75	2 - 3	1	8	0932 733	675.00
		75 - 100	3 - 4	1	8	0932 734	727.00



0996701

Accessories

	Order no.	List price EUR
Battery, 3V-Lithium, CR 2032	0220 704	3.70
Data cable opto to RS232	0996 701	74.00
Data cable opto to USB	0996 705	141.00
USB-keyboard interface cable	0997 770	241.00



0849 Precision dial micrometers



DIN
863-3



0849 501

Model

- DIN 863-3
- Reading: 0.01 mm
- Reading on the dial: 1 μm
- Reading parts are satin chrome finished
- Retraction stroke 1.5 mm

- Spindle made of hardened stainless steel
- Constant measuring force
- Locking lever
- Carbide measuring faces
- Thermally insulated

Delivery

- Wooden case

✂	¼	Measuring range mm	Pitch mm	Spindle dia. mm	Thimble dia. mm	Order no.	List price EUR
		0 - 25	0.5	7.5	17.5	0849 501	707.00
		25 - 50	0.5	7.5	17.5	0849 502	841.00

0850 Precision dial micrometers



DIN
863-3



0850 511

Model

- DIN 863-3
- Reading: 0.01 mm
- Reading on the dial: 1 μm
- Reading parts are satin Chrome finished
- Retraction stroke 1.2 mm

- Locking lever
- Carbide measuring faces
- Constant measuring force
- Thermally insulated
- Spindle made of hardened Stainless steel

- Adjustable tolerance markers

Delivery

- Wooden case
- incl. dial comparator gauge

✂	¼	Measuring range mm	Pitch mm	Spindle dia. mm	Thimble dia. mm	Order no.	List price EUR
		0 - 25	0.5	7.5	17.5	0850 511	559.00
		25 - 50	0.5	7.5	17.5	0850 512	620.00
		50 - 100	0.5	7.5	17.5	0850 514	659.00
		100 - 150	0.5	7.5	17.5	0850 516	704.00
		150 - 200	0.5	7.5	17.5	0850 518	737.00



0822 Disc micrometers



Model

- Factory standard
- Reading: 0.01 mm
- Carbide measuring faces
- Ratchet stop
- Disc dia. 60 mm
- Malleable cast iron frame, lacquered

Delivery

- Wooden case

Measuring range mm	Pitch mm	Spindle dia. mm	Thimble dia. mm	Order no.	List price EUR
Frame depth 50 mm					
0 - 15	1	6.5	20	0822 301	91.00
0 - 25	1	6.5	20	0822 302	138.00
0 - 50	1	6.5	20	0822 303	254.00
Frame depth 100 mm					
0 - 50	1	6.5	20	0822 304	416.00

0824 Micrometers for tube wall measurement



DIN
863-3

Model

- DIN 863-3
- Reading: 0.01 mm
- Reading parts are satin chrome finished
- Ratchet stop
- Hardened measuring faces

- Malleable cast iron frame, lacquered

Delivery

- Cardboard box

Measuring range mm	Pitch mm	Spindle dia. mm	Thimble dia. mm	Error limit mm	Order no.	List price EUR
Ball dia. 2.5 mm						
0 - 15	0.5	6.5	20	0.001	0824 302	174.00
Ball dia. 6.5 mm						
0 - 25	0.5	6.5	20	0.001	0824 303	176.00



0854 Blade micrometers



DIN
863-3

Model

- DIN 863-3
- Reading: 0.01 mm
- Reading parts are satin chrome finished
- Ratchet stop
- Thermally insulated
- Hardened spindle and anvil
- Coated steel frame

Delivery

- Plastic case
- From measuring range 25 - 50 mm upwards includes a setting standard

✂	¼	Measuring range mm	Pitch mm	Spindle dia. mm	Thimble dia. mm	Error limit mm	Order no.	List price EUR
Measuring faces dia. 0.8 x 7 mm								
		0 - 25	0.5	8	17.5	0.004	0854 301	247.00
		25 - 50	0.5	8	17.5	0.004	0854 302	299.00
		50 - 75	0.5	8	17.5	0.005	0854 303	321.00
		75 - 100	0.5	8	17.5	0.005	0854 304	348.00

0855 Micrometers with reduced measuring faces



DIN
863-3

Model

- DIN 863-3
- Reading: 0.01 mm
- Reading parts are satin chrome finished
- Locking lever
- Ratchet stop
- Carbide measuring faces
- Thermally insulated
- Hardened spindle and anvil
- Coated steel frame

Delivery

- Plastic case
- From measuring range 25 - 50 mm upwards includes a setting standard

✂	¼	Measuring range mm	Pitch mm	Spindle dia. mm	Thimble dia. mm	Error limit mm	Order no.	List price EUR
Measuring faces dia. 3 mm, length 8.5 mm								
		0 - 25	0.5	6.5	17.5	0.004	0855 301	178.00
		25 - 50	0.5	6.5	17.5	0.004	0855 302	218.00
		50 - 75	0.5	6.5	17.5	0.005	0855 303	247.00
		75 - 100	0.5	6.5	17.5	0.005	0855 304	261.00



0898 Settings gauges for micrometers



0898 104

Model

- Rod
- Special steel, aged
- Hardened measuring faces
- Tolerance zone js2
- Thermally insulated
- Parallel lapped measuring faces

⊗	⊗	Measuring range mm	Measuring faces dia. mm	Order no.	List price EUR
		25	6.5	0898 101	10.90
		50	6.5	0898 102	18.30
		75	6.5	0898 103	21.70
		100	6.5	0898 104	24.80
		125	6.5	0898 105	28.70
		150	6.5	0898 106	40.60
		175	6.5	0898 107	45.40
		200	6.5	0898 108	50.00
		225	6.5	0898 109	55.00
		250	6.5	0898 110	60.00
		275	6.5	0898 111	64.00
		300	10	0898 112	80.00
		325	10	0898 113	86.00
		350	10	0898 114	92.00
		375	10	0898 115	98.00
		400	10	0898 116	105.00
		425	10	0898 117	111.00
		450	10	0898 118	117.00
		475	10	0898 119	123.00
		500	10	0898 120	130.00
		525	10	0898 121	136.00
		550	10	0898 122	143.00
		575	10	0898 123	150.00
		600	10	0898 124	157.00
		625	10	0898 125	164.00
		650	10	0898 126	170.00

⊗	⊗	Measuring range mm	Measuring faces dia. mm	Order no.	List price EUR
		675	10	0898 127	177.00
		700	10	0898 128	184.00
		725	10	0898 129	191.00
		750	10	0898 130	198.00
		775	10	0898 131	205.00
		800	10	0898 132	212.00
		825	10	0898 133	217.00
		850	10	0898 134	224.00
		875	10	0898 135	232.00
		900	10	0898 136	239.00
		925	10	0898 137	245.00
		950	10	0898 138	252.00
		975	10	0898 139	260.00
		1000	10	0898 140	266.00
	▪	1050	10	0898 142	278.00
	▪	1150	10	0898 146	305.00
	▪	1250	10	0898 150	335.00
	▪	1350	10	0898 154	361.00
	▪	1450	10	0898 158	389.00
	▪	1550	10	0898 162	623.00
	▪	1650	10	0898 166	654.00
	▪	1750	10	0898 170	684.00
	▪	1850	10	0898 174	714.00
	▪	1950	10	0898 178	743.00



0870 Precision micrometers for thread flank measurement



**DIN
863-3**



Model

- DIN 863-3
- Reading 0.01 mm
- Reading parts are satin chrome finished
- Locking ring
- Ratchet stop
- Thermally insulated
- Spheroid ductile iron frame, lacquered

Delivery

- Wooden case
- **Thread flank inserts and setting standards must be ordered separately**

✕	📏	Measuring range	Pitch	Thimble dia.	Error limit	Spindle adjustment	Required length of setting standard	Order no.	List price
		mm	mm	mm	mm	mm	mm		EUR
For inserts with shank dimensions. dia. 3.5 x 13.5 mm									
		0 - 25	0.5	20	0.004	25	-	0870 301	295.00
		25 - 50	0.5	20	0.004	25	25	0870 302	308.00
		50 - 75	0.5	20	0.005	25	50	0870 303	331.00
		75 - 100	0.5	20	0.005	25	75	0870 304	362.00
		100 - 125	0.5	20	0.006	25	100	0870 305	396.00
		125 - 150	0.5	20	0.006	25	125	0870 306	431.00
		150 - 200	0.5	20	0.007	50	175	0870 307	614.00
		200 - 250	0.5	20	0.008	50	225	0870 309	671.00
		250 - 300	0.5	20	0.009	50	275	0870 311	738.00



0870 Thread flank inserts for external measurement

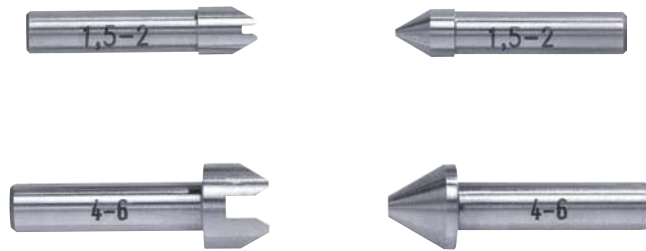

Model

- Made of hardened special steel and finely grinded
- Every insert is inscribed with the pitch details
- In a set (V-anvil + tapered anvil)
- Shank dimensions: 3.5 x 13.5 mm

Icon	Flank angle	Pitch mm	Applicable for UNC, UNF 60°	Thread pitch in TPI mm	Order no.	List price EUR
Metric ISO - threads						
	60°	0.35 - 0.5	72 - 48		0870 901	111.00
	60°	0.6 - 0.8	44 - 32		0870 903	96.00
	60°	0.9 - 1.25	28 - 18		0870 905	96.00
	60°	1.5 - 2	16 - 11		0870 907	96.00
	60°	2.5 - 3.5	10 - 7		0870 909	96.00
	60°	4 - 6	6 - 4		0870 911	111.00
Whitworth- threads						
	55°			60 - 48	0870 921	121.00
	55°			40 - 32	0870 923	105.00
	55°			28 - 22	0870 925	105.00
	55°			20 - 16	0870 927	105.00
	55°			14 - 11	0870 929	105.00
	55°			10 - 7	0870 931	105.00
	55°			6 - 4	0870 933	121.00
Metric ISO - Trapezoid threads (DIN 103)						
	30°	1.5			0870 941	285.00
	30°	2			0870 943	207.00
	30°	3			0870 945	182.00
	30°	4			0870 947	182.00
	30°	5-6			0870 949	182.00
	30°	7-8			0870 951	182.00
	30°	9-10			0870 953	207.00
	30°	12-14			0870 955	285.00





0870 Thread flank setting gauges for external measurement



Model

- Measuring faces made of hardened special steel
- One end is rounded, the lapped bore simplifies the fitting upon the conical insert
- Thermally insulated handle
- **Note: With trapezoid treads every pitch requires a separate setting standard**

		Length mm	Flank angle	Available for following pitches mm	Error limit µm	Order no.	List price EUR
Metric ISO - threads							
		25	60°		3	0870 801	70.00
		50	60°		3	0870 802	71.00
		75	60°		3	0870 803	72.00
		100	60°		4	0870 804	73.00
		125	60°		4	0870 805	74.00
		175	60°		4	0870 807	82.00
		225	60°		4	0870 809	92.00
		275	60°		4	0870 811	102.00
Whitworth- threads							
		25	55°		3	0870 821	70.00
		50	55°		3	0870 822	71.00
		75	55°		3	0870 823	72.00
		100	55°		4	0870 824	77.00
		125	55°		4	0870 825	78.00
		175	55°		4	0870 827	89.00
		225	55°		4	0870 829	103.00
		275	55°		4	0870 831	117.00
Metric ISO - Trapezoid threads (DIN 103)							
		25	30°	2 / 3 / 4 / 5 - 6 / 7 - 8 / 9 - 10	4	0870 841	153.00
		50	30°	2 / 3 / 4 / 5 - 6 / 7 - 8 / 9 - 10	4	0870 842	157.00
		75	30°	2 / 3 / 4 / 5 - 6 / 7 - 8 / 9 - 10	4	0870 843	161.00
		100	30°	3 / 4 / 5 - 6 / 7 - 8 / 9 - 10 / 12 - 14	5	0870 844	168.00
		125	30°	4 / 5 - 6 / 7 - 8 / 9 - 10 / 12 - 14	5	0870 845	182.00
		175	30°	4 / 5 - 6 / 7 - 8 / 9 - 10 / 12 - 14	5	0870 847	217.00
		225	30°	5 - 6 / 7 - 8 / 9 - 10 / 12 - 14	5	0870 849	265.00
		275	30°	5 - 6 / 7 - 8 / 9 - 10 / 12 - 14	5	0870 851	324.00

* When ordering the respective pitch must be specified



0864 Disc micrometers to measure gear tooth



DIN
863-3

Model

- DIN 863-3
- Reading: 0.01 mm
- Reading parts are satin chrome finished
- Modul 0.8 - 6
- Ratchet stop
- Hardened measuring faces
- Locking ring
- Friction coupling
- Thermally insulated

Delivery

- Wooden case

Measuring range mm	Disc dia. mm	Pitch mm	Thimble dia. mm	Error limit mm	Order no.	List price EUR
0 - 25	25	0.5	20	0.004	0864 321	317.00
25 - 50	25	0.5	20	0.004	0864 322	380.00
50 - 75	25	0.5	20	0.005	0864 323	412.00
75 - 100	25	0.5	20	0.005	0864 324	447.00
100 - 125	25	0.5	20	0.006	0864 325	483.00
125 - 150	25	0.5	20	0.006	0864 326	517.00
150 - 175	25	0.5	20	0.007	0864 327	556.00
175 - 200	25	0.5	20	0.007	0864 328	594.00

0933 DIGI-MET® Disc micrometers to measure gear tooth



OPTO

Model

- Factory standard
- Selectable resolution 0.01 mm / 0.001 mm; 0.0005 inch / 0.00005 inch
- Non-rotating spindle
- Linear measuring system
- Locking lever
- Thermally insulated
- Ratchet stop

Functions

- ON / OFF
- Set to zero at any point
- mm / inch switching
- MIN / MAX
- Hold
- PRESET-Function (setting a numerical value)
- TOL (tolerance value input)
- Data output Opto RS 232

Delivery

- Wooden case

Measuring range mm	inch	Disc dia. mm	Module	Pitch mm	Spindle dia. mm	Order no.	List price EUR
0 - 25	0 - 1	25	0.4	1	8	0933 701	779.00
25 - 50	1 - 2	25	0.4	1	8	0933 702	857.00
50 - 75	2 - 3	25	0.4	1	8	0933 703	909.00
75 - 100	3 - 4	25	0.4	1	8	0933 704	961.00
100 - 125	4 - 5	30	0.6	1	8	0933 705	1013.00
125 - 150	5 - 6	30	0.6	1	8	0933 706	1065.00
150 - 175	6 - 7	30	0.6	1	8	0933 707	1117.00
175 - 200	7 - 8	30	0.6	1	8	0933 708	1195.00



Accessories

Accessories	Order no.	List price EUR
Battery, 3V-Lithium, CR 2032	0220 704	3.70
Data cable opto to RS232	0996 701	74.00
Data cable opto to USB	0996 705	141.00
USB-keyboard interface cable	0997 770	241.00



0890 Wire thickness micrometer



Model

- Factory standard
- Reading: 0.01 mm
- Readings parts are satin chrome finished
- Ratchet stop
- Carbide measuring faces

Delivery

- Cardboard box

⌘	⌘	Measuring range mm	Pitch mm	Spindle dia. mm	Thimble dia. mm	Order no.	List price EUR
		0 - 10	0.5	6	18	0890 511	66.00



0884 Internal micrometer with measuring jaws

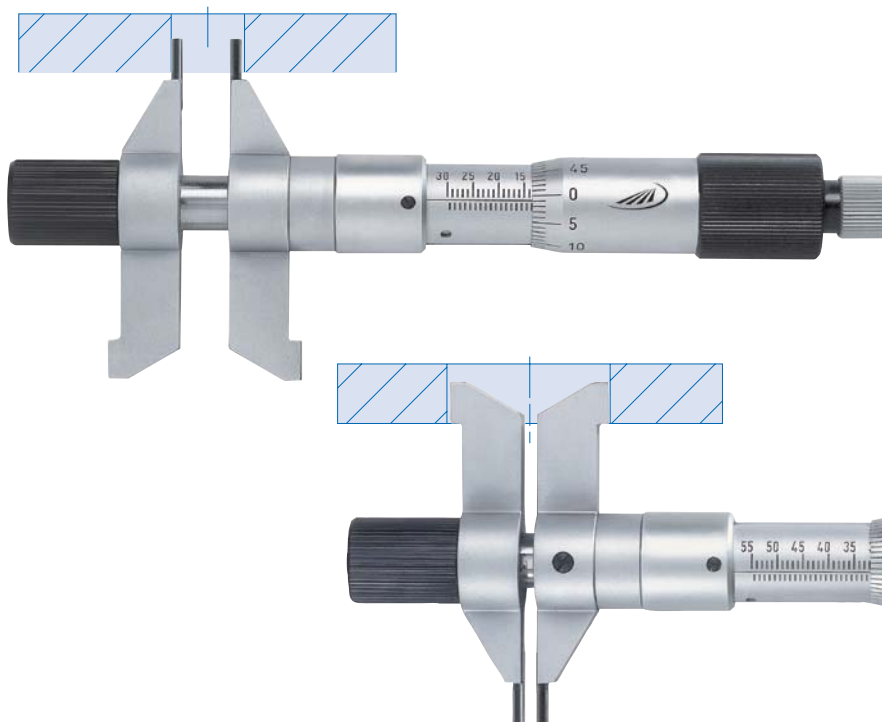

Model

**DIN
863-4**

- DIN 863-4
- Reading: 0.01 mm
- Reading parts are satin chrome finished
- Forward friction coupling
- Cylindrical carbide tipped measuring faces
- Measuring jaws on both sides (measuring ranges 5-30 mm, 30-55 mm)
- Divisions on both sides

Delivery

- Wooden case

⌘	⌘	Measuring range mm	Thimble dia. mm	Pitch mm	Error limit µm	Order no.	List price EUR
		5 - 55	20	0.5	2.5	0884 501	794.00

2

0885 Internal micrometers with measuring jaws



0885 502

Model

- Factory standard
- Reading: 0.01 mm
- Reading parts and body are satin chrome finished
- Ratchet stop
- Carbide measuring faces
- Cylindrical carbide tipped measuring faces

Delivery

- Plastic case

⌘	⌘	Measuring range mm	Thimble dia. mm	Pitch mm	Order no.	List price EUR
		5 - 30	17	0.5	0885 501	176.00
		25 - 50	17	0.5	0885 502	195.00
		50 - 75	17	0.5	0885 503	204.00
		75 - 100	17	0.5	0885 504	245.00
		100 - 125	17	0.5	0885 505	311.00
		125 - 150	17	0.5	0885 506	359.00
		150 - 175	17	0.5	0885 507	457.00
		175 - 200	17	0.5	0885 508	518.00



0888 Internal micrometers cylindrical version



**DIN
863-4**



Model

- DIN 863-4
- Reading: 0.01 mm
- Reading parts are satin chrome finished
- Carbide measuring faces dia. 6 mm, spherical lapped
- From measuring range 100 - 125 mm with thermal insulation

- From measuring range 100 - 125 mm with locking ring

Delivery

- Wooden case

✕	¼	Measuring range mm	Thimble dia. mm	Pitch mm	Error limit µm	Order no.	List price EUR
		25 - 30	15	0.5	4	0888 501	154.00
		30 - 35	15	0.5	4	0888 502	154.00
		35 - 50	15	0.5	4	0888 503	154.00
		50 - 75	16	0.5	5	0888 504	160.00
		75 - 100	17	0.5	5	0888 505	166.00
		100 - 125	20	0.5	6	0888 506	185.00
		125 - 150	20	0.5	6	0888 507	190.00
		150 - 175	20	0.5	7	0888 508	197.00
		175 - 200	20	0.5	7	0888 509	204.00
		200 - 225	20	0.5	8	0888 510	210.00
		225 - 250	20	0.5	8	0888 511	216.00
		250 - 275	20	0.5	9	0888 512	224.00
		275 - 300	20	0.5	9	0888 513	232.00
		300 - 325	20	0.5	10	0888 514	241.00
		325 - 350	20	0.5	10	0888 515	247.00
		350 - 375	20	0.5	11	0888 516	257.00
		375 - 400	20	0.5	11	0888 517	263.00
		400 - 425	20	0.5	12	0888 518	273.00
		425 - 450	20	0.5	12	0888 519	281.00
		450 - 475	20	0.5	13	0888 520	288.00
		475 - 500	20	0.5	13	0888 521	295.00

0888 Holder for internal micrometers



Model

- Ideal for all internal micrometers from series 0888 / 0892
- Length 200 mm

✕	¼	Order no.	List price EUR
		0888 101	49.00



0892 Internal micrometers with interchangeable extensions



DIN
863-4

0892 501

Model

- DIN 863-4
- Reading: 0.01 mm
- Reading parts are satin chrome finished

Delivery

- Threaded extension rods with thermally insulated handle
- Carbide measuring faces, spherical lapped
- Wooden case

☒	☒	Measuring range mm	Thimble dia. mm	Pitch mm	Extensions	Error limit µm	Order no.	List price EUR
		50 - 150	17	0.5	25 / 50	6	0892 501	376.00
		50 - 250	17	0.5	25 / 50 / 100	8	0892 502	461.00
		50 - 450	17	0.5	25 / 50 / 100 / 200	10	0892 503	568.00
		50 - 850	17	0.5	25 / 50 / 100 / 200 / 400	12	0892 504	716.00
		50 - 1450	17	0.5	25 / 50 / 100 / 200 / 400 / 600	15	0892 505	909.00

0892 Extensions for internal micrometers



0892 334

☒	☒	Length mm	Order no.	List price EUR
		25	0892 332	71.00
		50	0892 333	72.00
		100	0892 334	80.00
		200	0892 336	98.00
		400	0892 339	130.00
		600	0892 340	182.00



0894 Precision internal micrometers with extensions



**DIN
863-4**



Model

- DIN 863-4
- Measuring ends: dia. 7 mm x 6 mm long, carbide tipped spherical lapped
- Thread pitch 1 mm
- Internal spring mounted rods with thermal protective sleeves
- Extensions greater than 100 mm: external steel tube dia. 17 mm, with thermal insulation
- Extensions 500 and 1000 mm: strengthened specification - steel tube dia. 32 mm for larger measuring ranges

Delivery

- Wooden case

- Basic internal micrometer is adjustable: 50 mm. The spindle is tight, so that during measurement the thimble does not adjust itself.

✕	⊘	Measuring range mm	Length of extensions mm (tube dia. 17 mm)	Length of extensions (tube dia. 32 mm)	Error limit μm	Order no.	List price EUR
		100 - 150	only micrometer, excludes case	-	4	0894 504	224.00
		100 - 300	50 / 100	-	7	0894 510	595.00
		100 - 500	50 / 100 / 200	-	9	0894 514	802.00
		100 - 900	50 / 100 / 200 / 400	-	11	0894 518	1036.00
		100 - 1300	50 / 100 / 200 / 400 / 400	-	13	0894 522	1276.00
		100 - 1700	50 / 100 / 200 / 400 / 800	-	15	0894 526	1313.00
		100 - 2100	50 / 100 / 200 / 400 / 400 / 800	-	18	0894 530	1540.00
		100 - 2500	50 / 100 / 200 / 400 / 800 / 800	-	21	0894 534	1582.00
		100 - 2000	50 / 100 / 200 / 200	500 / 1 x 1000	18	0894 538	2761.00
		100 - 3000	50 / 100 / 200 / 200	500 / 2 x 1000	30	0894 542	3601.00
		100 - 4000	50 / 100 / 200 / 200	500 / 3 x 1000	40	0894 546	4470.00
	▪	100 - 5000	50 / 100 / 200 / 200	500 / 4 x 1000	50	0894 550	5311.00
	▪	100 - 6000	50 / 100 / 200 / 200	500 / 5 x 1000	60	0894 554	6152.00

With the larger measuring ranges we recommend that the ends of the precision internal micrometer to be placed and/or held on 2 points with an approximate distance of 22% of the measuring length, thus minimizing deflection. The error indicated in the table above refers to the maximum deflection of the appropriate set. When smaller dimensions are measured, the error is smaller and corresponds to the error value of the smaller sets.

0894 Individual extensions



✕	⊘	Length mm	Tube dia. mm	Order no.	List price EUR
		50	17	0894 804	160.00
		100	17	0894 806	182.00
		200	17	0894 810	197.00
		400	17	0894 820	217.00
		800	17	0894 834	247.00
		500	32	0894 854	811.00
		1000	32	0894 872	842.00



HELIOS · PREISSER

0940 DIGI-MET® 2 point internal micrometers with extensions



Model

- Non-rotating spindle
- LCD display 6 mm
- Carbide measuring faces Ø 8 mm
- Selectable resolution 0.01 mm / 0.001 mm ; 0.0005 inch / 0.00005 inch
- Ratchet stop
- For precise measuring of inner dimensions up to 5000 mm

Functions

- ON / OFF
- Set to zero at any point
- mm / inch switching
- Data output Opto RS 232
- MIN / MAX
- Hold
- TOL (tolerance value input)
- PRESET-Function (setting a numerical value)

Delivery

- Wooden case



NEW

0940 816



»	¼	Measuring range mm	Pitch mm	Extensions	Order no.	List price EUR
		150 - 175	1	Basic unit	0940 816	835.00
		150 - 350	1	25 / 50 / 100	0940 823	1195.00
		150 - 550	1	25 / 50 / 100 / 200	0940 829	1360.00
		150 - 950	1	25 / 50 / 100 / 200 / 400	0940 833	1530.00
		150 - 1550	1	25 / 50 / 100 / 200 / 200 / 400 / 400	0940 839	1750.00



0996705

0996701

0997770

Accessories

	Order no.	List price EUR
Battery, 3V-Lithium, CR 2032	0220 704	3.70
Data cable opto to RS232	0996 701	74.00
Data cable opto to USB	0996 705	141.00
USB-keyboard interface cable	0997 770	241.00

0940 Individual extension



M 12x1



»	¼	Length mm	Tube dia. mm	Order no.	List price EUR
		25	17	0940 891	129.00
		50	17	0940 892	145.00
		100	17	0940 893	179.00
		200	17	0940 894	219.00
		400	17	0940 895	295.00
		1000	32	0940 896	895.00



1921 3 point internal micrometers



**DIN
863-4**



1921 512



1921 534

Model

- DIN 863-4
- Reading: 0.001 mm*
- Reading: 0.005 mm
- Reading parts are satin chrome finished
- Pitch 0.5 mm
- Carbide tipped measuring pins from measuring range 12 mm

Delivery

- Plastic case
- Setting ring inclusive
- Calibration certificate for ring and device



Inclusive!

✂	📏	Measuring range mm	Measuring depth mm	Thimble dia. mm	Error limit µm	Order no.	List price EUR
▪		6 - 8	58	16	4	1921 510*	384.00
▪		8 - 10	58	16	4	1921 512*	384.00
▪		10 - 12	58	16	4	1921 514*	384.00
▪		12 - 16	64	16	4	1921 516*	384.00
▪		16 - 20	64	16	4	1921 518*	405.00
▪		20 - 25	68	25	4	1921 520	416.00
▪		25 - 30	68	25	4	1921 522	421.00
▪		30 - 40	76	25	4	1921 524	473.00
▪		40 - 50	76	25	4	1921 526	473.00
▪		50 - 60	79	25	5	1921 528	545.00
▪		60 - 70	79	25	5	1921 530	561.00
▪		70 - 85	97	25	5	1921 532	577.00
▪		85 - 100	97	25	5	1921 534	592.00
▪		100 - 125	132	25	6	1921 536	831.00
▪		125 - 150	132	25	6	1921 538	982.00
▪		150 - 175	132	25	7	1921 540	1034.00
▪		175 - 200	132	25	7	1921 542	1091.00



1920 Set of 3 point internal micrometers



**DIN
863-4**



Model

- DIN 863-4
- Reading: 0.001 mm*
- Reading: 0.005 mm
- Reading parts are satin chrome finished
- Pitch 0.5 mm
- Carbide tipped measuring pins from measuring range 12 mm
- Ratchet stop
- From measuring range 12 mm for through and blind holes

Delivery

- Plastic case
- Setting ring inclusive
- Calibration certificate for ring and device

2

⌘	⚙	Measuring range mm	Thimble dia. mm	Number of devices	Order no.	List price EUR
▪		6 - 12	16	3	1920 574	1081.00
▪		12 - 20	16	2	1920 576	758.00
▪		20 - 50	25	4	1920 578	1870.00
▪		50 - 100	25	4	1920 580	2234.00

1920 Measuring depth extensions for 3 point internal micrometers



Model

- Suitable for devices 1920, 1921, 1923 and 1924



⌘	⚙	Measuring range mm	Length mm	Order no.	List price EUR
		6 - 12	75	1920 910	88.00
		12 - 20	75	1920 914	94.00
		20 - 30	150	1920 920	99.00
		30 - 200	150	1920 924	119.00



1923 DIGI-MET® 3 point internal micrometers



NEW

Model

- DIN 863-4
- Reading: 0.001 mm / .00005 inch
- Protection class IP52
- LCD display 8.5 mm
- Ratchet stop
- For through holes
- From measuring range 12 mm for through and blind holes
- From measuring range 12 mm with carbide tipped measuring faces

Functions

- ON / OFF
- Set to zero at any point
- mm / inch switching
- ABS (display can be set to zero without losing the Preset value)
- **Quick-Lock** (key lock)
- PRESET-Function (setting a numerical value)
- Variable data output RS 232 + Digimatic + USB

Delivery

- Plastic case
- Incl. setting ring
- Certificate for setting ring and micrometer



Inclusive!

✕	☒	Measuring range mm	Measuring depth mm	Error limit µm	Order no.	List price EUR
▪		6 - 8	58	4	1923 510	1055.00
▪		8 - 10	58	4	1923 512	1055.00
▪		10 - 12	58	4	1923 514	1065.00
▪		12 - 16	64	4	1923 516	1065.00
▪		16 - 20	64	4	1923 518	1110.00
▪		20 - 25	68	4	1923 520	1130.00
▪		25 - 30	68	4	1923 522	1140.00
▪		30 - 40	76	4	1923 524	1190.00
▪		40 - 50	76	4	1923 526	1195.00
▪		50 - 60	79	5	1923 528	1285.00
▪		60 - 70	79	5	1923 530	1315.00
▪		70 - 85	97	5	1923 532	1345.00
▪		85 - 100	97	5	1923 534	1395.00
▪		100 - 125	132	6	1923 536	1695.00
▪		125 - 150	132	6	1923 538	1895.00
▪		150 - 175	132	7	1923 540	2040.00
▪		175 - 200	132	7	1923 542	2215.00



1998720

1998501

1997501

Accessories

	Order no.	List price EUR
Battery, 3V-Lithium, CR 2032	0220 704	3.70
Data cable DATA VARIABLE to RS232	1997 501	48.00
Data cable DATA VARIABLE to digimatic	1998 501	61.00
Data cable DATA VARIABLE to USB	1998 720	69.00



HELIOS · PREISSER

1923 DIGI-MET® Set of 3 point internal micrometers



Delivery

- Plastic case
- Incl. setting ring
- Certificate for setting ring and micrometer



Measuring range mm	Error limit µm	Number of devices	Order no.	List price EUR
6 - 12	4	3	1923 574	1700.00
12 - 20	4	2	1923 576	1500.00
20 - 50	4	4	1923 578	2200.00
50 - 100	5	4	1923 580	2700.00



1998720



1998501



1997501

Accessories

	Order no.	List price EUR
Battery, 3V-Lithium, CR 2032	0220 704	3.70
Data cable DATA VARIABLE to RS232	1997 501	48.00
Data cable DATA VARIABLE to digimatic	1998 501	61.00
Data cable DATA VARIABLE to USB	1998 720	69.00

1923 DIGI-MET® Basic unit for 3 point internal micrometers



Model

- Reading: 0.001 mm / .00005 inch
- Protection class IP52
- LCD display 8,5 mm
- Ratchet stop
- Mounting thread for changing of measuring heads

Functions

- ON / OFF
- Set to zero at any point
- mm / inch switching
- ABS (display can be set to zero without losing the Preset value)
- Quick-Lock (key lock)
- PRESET-Function (setting a numerical value)
- Variable data output RS 232 + Digimatic + USB

Measuring range mm	Order no.	List price EUR
6 - 20	1923 100	765.00
20 - 100	1923 200	765.00
100 - 200	1923 300	765.00



1924 DIGI-MET® 3 point internal measuring pistols



NEW

Model

- For through holes
- Mounting thread for changing of measuring heads
- From measuring range 12 mm for through and blind holes
- From measuring range 12 mm with carbide tipped measuring faces
- Digital indicator recommended as display device

Delivery

- Plastic case
- Incl. setting ring
- Without display device



Inclusive!

⌘	⚙	Measuring range mm	Measuring depth mm	Order no.	List price EUR
▪		6 - 8	58	1924 510	785.00
▪		8 - 10	58	1924 512	785.00
▪		10 - 12	58	1924 514	795.00
▪		12 - 16	64	1924 516	805.00
▪		16 - 20	64	1924 518	835.00
▪		20 - 25	68	1924 520	835.00
▪		25 - 30	68	1924 522	865.00
▪		30 - 40	76	1924 524	910.00
▪		40 - 50	76	1924 526	915.00
▪		50 - 60	79	1924 528	995.00
▪		60 - 70	79	1924 530	1035.00
▪		70 - 85	97	1924 532	1070.00
▪		85 - 100	97	1924 534	1120.00
▪		100 - 125	132	1924 536	1380.00
▪		125 - 150	132	1924 538	1590.00
▪		150 - 175	132	1924 540	1700.00
▪		175 - 200	132	1924 542	1900.00



1726506



172650660

Accessories

DIGI-MET® Indicators
DIGI-MET® Indicators with integrated wireless

Order no.

1726 506
172650 660

List price
EUR

365.00
425.00



1924 DIGI-MET® Set of 3 point internal measuring pistols



Model

- For through holes
- From measuring range 12 mm for through and blind holes
- From measuring range 12 mm with carbide tipped measuring faces
- Digital indicator recommended as display device

Delivery

- Plastic case
- Incl. setting ring
- Without display device

▶▶	📏	Measuring range mm	Number of devices	Order no.	List price EUR
▪		6 - 12	3	1924 574	1400.00
▪		12 - 20	2	1924 576	1200.00
▪		20 - 50	4	1924 578	2000.00
▪		50 - 100	4	1924 580	2600.00

2

1924 DIGI-MET® Basic unit for 3 point internal measuring pistols



Model

- Mounting thread for changing of measuring heads
- Support for indicators with shaft Ø 8 mm
- Measuring range 6-100 mm incl. adapter for 6-20 mm

Delivery

- Plastic case

▶▶	📏	Measuring range mm	Order no.	List price EUR
		6 - 100	1924 100	480.00
		20 - 100	1924 200	480.00
		100 - 200	1924 300	560.00



1922 Individual measuring heads for 1923 / 1924



1922 512



1922 534

Model

- From measuring range 12 mm with carbide tipped measuring faces
- From measuring range 12 mm for through and blind holes

▶	⚙	Measuring range mm	Order no.	List price EUR
		6 - 8	1922 510	290.00
		8 - 10	1922 512	290.00
		10 - 12	1922 514	295.00
		12 - 16	1922 516	295.00
		16 - 20	1922 518	305.00
		20 - 25	1922 520	315.00
		25 - 30	1922 522	325.00
		30 - 40	1922 524	365.00
		40 - 50	1922 526	365.00
		50 - 60	1922 528	435.00
		60 - 70	1922 530	445.00
		70 - 85	1922 532	460.00
		85 - 100	1922 534	475.00
		100 - 125	1922 536	695.00
		125 - 150	1922 538	845.00
		150 - 175	1922 540	915.00
		175 - 200	1922 542	945.00

1920 Measuring depth extensions for 3 point internal micrometers



Model

- Suitable for devices 1920, 1921, 1923 and 1924



▶	⚙	Measuring range mm	Length mm	Order no.	List price EUR
		6 - 12	75	1920 910	88.00
		12 - 20	75	1920 914	94.00
		20 - 30	150	1920 920	99.00
		30 - 200	150	1920 924	119.00



0882 Depth micrometers



DIN
863-2

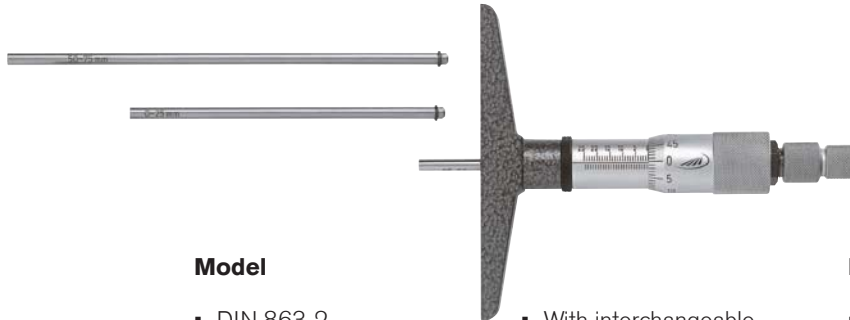

Model

- DIN 863-2
- Reading: 0.01 mm
- Reading parts are satin chrome finished
- Locking ring
- Friction coupling

Delivery

- Wooden case

- With interchangeable steel measuring inserts dia. 4 mm
- Hardened measuring faces

»	¼	Measuring range mm	Bridge length mm	Pitch mm	Thimble dia. mm	Error limit mm	Order no.	List price EUR
Measuring faces dia. 0.8. length 8.5 mm								
		0 - 50	50	0.5	20	0.004	0882 300	263.00
		0 - 75	50	0.5	20	0.005	0882 301	286.00
		0 - 100	100	0.5	20	0.005	0882 303	314.00
		0 - 150	100	0.5	20	0.006	0882 304	368.00
		0 - 300	100	0.5	20	0.009	0882 306	592.00

0886 Micrometer heads



DIN
863-2



Model

- DIN 863-2
- Reading: 0.01 mm
- Reading parts are satin chrome finished
- Carbide measuring faces

Delivery

- Plastic case

»	¼	Measuring range mm	Spindle dia. mm	Thimble dia. mm	Error limit mm	Description	Order no.	List price EUR
		0 - 6.5	3.5	9.5	0.003	without ratchet stop	0886 503	23.40
		0 - 13	6.5	13.5	0.003	without ratchet stop	0886 505	27.00
		0 - 25	6.5	18	0.003	with ratchet stop	0886 507	23.40
		0 - 25	8	18	0.003	with ratchet stop, non-rotating spindle	0886 513	41.60



SAMPLES INDICATORS

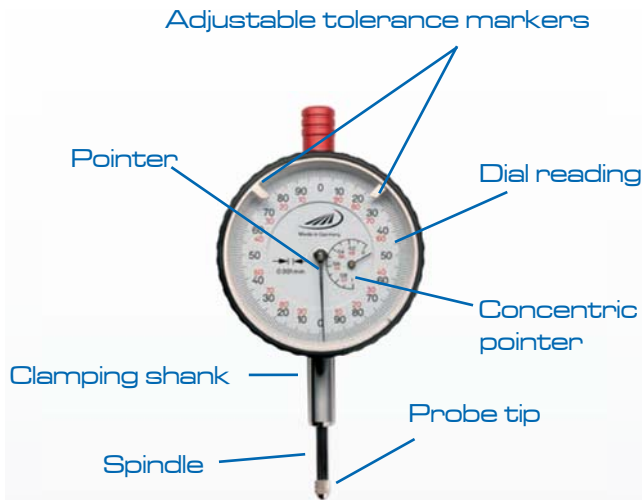

Specifications

- Housing made from metal or polyamide
- Replacement probe tips M 2,5
- Shockproof devices available
- Water and oil proof devices available

Electronic functions

QuickStart Electronic:
Moving the spindle starts your measurement



QuickLock Function:
Single keys can be locked individually



Data Variable:
Interface for USB, RS 232 & Digimatic



Integrated data transmission (Integrated Wireless)



Individual tolerance limit values

Data Variable Interface



Combined analogue / digital display

NEW

1734i
with integrated wireless

Matching accessories for our Indicators



MEASURING TABLES



MEASURING STANDS

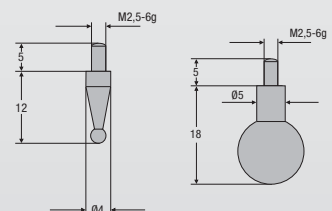

MEASURING INSERTS

3. CHAPTER INDICATORS

122	Indicators
129	Dial gauges
134	Precision indicators
135	Accessories for dial gauges and precision indicators
137	Measuring inserts for dial gauges
141	Dial test indicators
143	Depth gauges, depth measuring base
144	Dial thickness gauges
146	Internal and external caliper gauges
150	Internal bore gauges for blind holes
151	Analogue internal precision bore gauges
153	Crankshaft gauges / Length measuring instruments
154	Length measuring instruments for internal incisions
155	Universal comparator gauge
158	Comparator gauge UHRTAST
164	Magnetic measuring stands
168	Measuring tables
171	Bench centres
176	Shaft measuring instruments



1722 / 1723 / 1724 DIGI-MET® Indicators



1722 502



1723 502



1724 502

Model

- Housing Ø 60 mm
- Replacement probe tip M 2.5
- Protection class IP52
- Clamping shank Ø 8 mm
- LCD display with 12 mm high numerals
- Accuracy according to factory standard

Functions

- ON / OFF
- **Quick-Start**
- **Quick-Lock** (key lock)
- Set to zero at any point
- Reversal of counting direction
- mm / inch switching
- Individual key lock

Delivery

- Cardboard box

- PRESET-Function (setting a numerical value)
- Variable data output RS 232 + Digimatic + USB

Marked	%	Measuring span	Resolution mm		Error limit	Measuring force	Order no.	List price
		mm	mm	inch	mm	N		EUR
		12.5	0.01	.0005	0.02	0.5 - 1	1722 502	138.00
		12.5	0.005	.0001	0.015	0.5 - 1	1723 502	174.00
		12.5	0.001	.00005	0.005	0.5 - 1	1724 502	284.00



1998720



1997501



1998501



1739920

Accessories

	Order no.	List price
Battery, 3V-Lithium, CR 2032	0220 704	3.70
Data cable DATA VARIABLE to USB	1998 720	69.00
Data cable DATA VARIABLE to RS232	1997 501	48.00
Data cable DATA VARIABLE to digimatic	1998 501	61.00
Cable release	1739 920	14.30



1726 / 1728 DIGI-MET® Indicators



1726 502



1728 502

Model

- Aluminium housing
- Hardened stainless steel spindle
- Outer ring (Bezel) Ø 60 mm
- Replacement probe tip M 2.5
- Protection class IP42
- Clamping shank Ø 8 mm
- Display unit can be rotated through 280°
- LCD display with 11 mm high numerals
- Factory standard

Functions

- ON / OFF
- Quick-Start
- Quick-Lock (key lock)
- Set to zero at any point
- mm / inch switching
- ABS (display can be set to zero without losing the Preset value)
- TOL (tolerance value input)
- Reversal of counting direction
- Factor input
- Individual key lock
- PRESET-Function (setting a numerical value)
- Variable data output RS 232 + Digimatic + USB

Delivery

- Cardboard box

»	¼	Measuring span		Resolution		Error limit		Repeatability	Measuring force	Order no.	List price
		mm		mm	inch	total span mm	partial span**mm				
Reading 0.001 mm											
		12.5		0.001	.00005	0.004	0.002	0.001	0.65 - 0.9	1726 502	331.00
		25		0.001	.00005	0.004	0.002	0.001	0.65 - 1.15	1726 506	365.00
		50		0.001	.00005	0.007	0.002	0.001	1.25 - 2.7	1726 510	642.00
		100		0.001	.00005	0.008	0.002	0.001	1.6 - 3.5	1726 514	795.00
Reading 0.01 mm											
		12.5		0.01	.0005	0.02	-	0.01	0.65 - 0.9	1728 502	277.00
		25		0.01	.0005	0.02	-	0.01	0.65 - 1.15	1728 506	353.00
		50		0.01	.0005	0.02	-	0.01	1.25 - 2.7	1728 510	576.00
		100		0.01	.0005	0.02	-	0.01	1.6 - 3.5	1728 514	737.00

* Reading switchable: 0.0005 / 0.001 / 0.002 / 0.005 / 0.010 mm

** Partial span = 25 steps by step value 0.0005 mm



1998720

1998501

1997501

1739910

Accessories

	Order no.	List price
Battery, 3V-Lithium, CR 2450	1998 770	5.70
Data cable DATA VARIABLE to USB	1998 720	69.00
Data cable DATA VARIABLE to RS232	1997 501	48.00
Data cable DATA VARIABLE to digimatic	1998 501	61.00
Cable release	1739 910	38.40



1730 / 1732 DIGI-MET® Indicators



Model

- Aluminium housing
- Outer ring (Bezel) Ø 60 mm
- Replacement probe tip M 2.5
- Protection class IP54
- Clamping shank Ø 8 mm
- Display unit can be rotated through 280°
- LCD display with 11 mm high numerals
- Factory standard

Functions

- ON / OFF
- Quick-Start**
- Quick-Lock** (key lock)
- Set to zero at any point
- mm / inch switching
- ABS (display can be set to zero without losing the Preset value)
- TOL (tolerance value input)
- Reversal of counting direction

Delivery

- Cardboard box

✕	¼	Measuring span		Resolution		Error limit		Repeatability	Measuring force N	Order no.	List price EUR
		mm		mm	inch	total span mm	partial span**mm				
		12.5		0.001	.00005	0.004	0.002	0.001	0.65 - 0.9	1730 502	367.00
		25		0.001	.00005	0.004	0.002	0.001	0.65 - 1.15	1730 506	414.00
		12.5		0.01	.0005	0.02	-	0.01	0.65 - 1.4	1732 502	310.00
		25		0.01	.0005	0.02	-	0.01	1 - 2.25	1732 506	391.00

* Reading switchable: 0.0005 / 0.001 / 0.002 / 0.005 / 0.010 mm

** Partial span= 25 steps by step value 0.0005 mm



Accessories

	Order no.	List price EUR
Battery, 3V-Lithium, CR 2450	1998 770	5.70
Data cable DATA VARIABLE to USB	1998 720	69.00
Data cable DATA VARIABLE to RS232	1997 501	48.00
Data cable DATA VARIABLE to digimatic	1998 501	61.00
Cable release	1739 910	38.40



HELIOS · PREISSER

1734 DIGI-MET® indicators with combined analogue / digital display



1734 502



1734 506

Model

- Aluminium housing
- Hardened stainless steel spindle
- Outer ring (Bezel) Ø 60 mm
- Replacement probe tip M 2.5
- Protection class IP42
- Clamping shank Ø 8 mm
- Display unit can be rotated through 280°
- LCD display with 8.5 mm high numerals
- Factory standard

Functions

- ON / OFF
- **Quick-Start**
- **Quick-Lock** (key lock)
- Set to zero at any point
- mm / inch switching
- ABS (display can be set to zero without losing the Preset value)
- TOL (tolerance value input)
- MIN / MAX
- TIR (MIN-MAX differential)
- Reversal of counting direction
- Factor input
- Individual key lock
- Variable data output RS 232 + Digimatic + USB
- PRESET-Function (setting a numerical value)

Delivery

- Cardboard box

»	%	Measuring span		Resolution		Error limit		Repeatability	Measuring force	Order no.	List price
		mm		mm	inch	total span mm	partial span**mm				
		12.5		0.001	.00005	0.004	0.002	0.001	0.65 - 0.9	1734 502	381.00
		25		0.001	.00005	0.004	0.002	0.001	0.65 - 1.15	1734 506	437.00

* Reading switchable: 0.0005 / 0.001 / 0.002 / 0.005 / 0.010 mm

** Partial span= 25 steps by step value 0.0005 mm

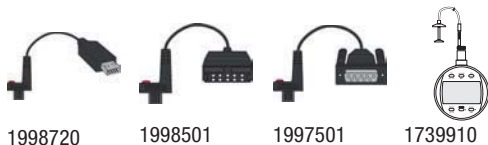

1998720

1998501

1997501

1739910

Accessories

	Order no.	List price
Battery, 3V-Lithium, CR 2450	1998 770	5.70
Data cable DATA VARIABLE to USB	1998 720	69.00
Data cable DATA VARIABLE to RS232	1997 501	48.00
Data cable DATA VARIABLE to digimatic	1998 501	61.00
Cable release	1739 910	38.40



1734 DIGI-MET® indicator with combined analogue / digital display

for comparator gauges



1734 522

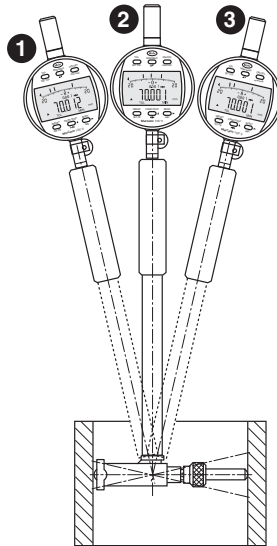

Application

The turning point can be determined automatically in measurements with a 2 point internal measuring device through commuting. The actual value is detected and stored by the MIN function and appears on the display

Model

- Aluminium housing
- Hardened stainless steel spindle
- Outer ring (Bezel) Ø 60 mm
- Replacement probe tip M 2.5
- Protection class IP42
- Clamping shank Ø 8 mm
- Display unit can be rotated through 280°
- LCD display with 8.5 mm high numerals
- Factory standard

Functions

- ON / OFF
- **Quick-Start**
- **Quick-Lock** (key lock)
- Set to zero at any point
- mm / inch switching
- ABS (display can be set to zero without losing the Preset value)
- TOL (tolerance value input)
- MIN / MAX
- Reversal of counting direction
- Factor input
- Individual key lock
- Variable data output RS 232 + Digimatic + USB
- PRESET-Function (setting a numerical value)

Delivery

- Cardboard box

Marked	Marked	Measuring span		Resolution		Error limit		Repeatability	Measuring force	Order no.	List price
		mm		mm	inch	total span mm	partial span**mm				
		12.5		0.001	.00005	0.004	0.002	0.001	0.65 - 0.9	1734 522	494.00

* Reading switchable: 0.0005 / 0.001 / 0.002 / 0.005 / 0.010 mm

** Partial span= 25 steps by step value 0.0005 mm



Accessories

	Order no.	List price
Battery, 3V-Lithium, CR 2450	1998 770	5.70
Data cable DATA VARIABLE to USB	1998 720	69.00
Data cable DATA VARIABLE to RS232	1997 501	48.00
Data cable DATA VARIABLE to digimatic	1998 501	61.00
Cable release	1739 910	38.40



1726i / 1734i DIGI-MET® Indicators with integrated wireless



172650 260



173450 260



integrated iw wireless

NOVELTY
Data transmission without cable or radio module

3

Model

- Aluminium housing
- Outer ring (Bezel) Ø 60 mm
- Replacement probe tip M2.5
- Protection class IP42
- Clamping shank Ø 8mm
- Display can be rotated through 280°
- LCD display with 11 mm high numerals
- Factory standard

Functions

- ON / OFF
- **Quick-Start**
- **Quick-Lock** (key lock)
- Set to zero at any point
- mm / inch switching
- ABS (display can be set to zero without losing the Preset value)
- TOL (tolerance value input)
- Reversal of counting direction

Delivery

- Cardboard box

»	¼	Measuring span	Resolution		Error limit		Repeatability	Measuring force	Order no.	List price EUR
		mm	mm	inch	total span mm	partial span**mm	mm	N		
		12.5	0.0005	.00002	0.004	0.002	0.001	0.65 - 0.9	172650 260	391.00
		25	0.0005	.00002	0.004	0.002	0.001	0.65 - 1.15	172650 660	425.00
With combined analogue / digital display and MIN / MAX / TIR Function										
		12.5	0.0005	.00002	0.004	0.002	0.001	0.65 - 0.85	173450 260	441.00
		25	0.0005	.00002	0.004	0.002	0.001	0.65 - 0.9	173450 660	497.00

* Reading switchable: 0.0005 / 0.001 / 0.002 / 0.005 / 0.010 mm
 ** Partial span= 25 steps by step value 0.0005 mm



1739910



1998780

Accessories

	Order no.	List price EUR
Battery, 3V-Lithium, CR 2450	1998 770	5.70
Cable release	1739 910	38.40
i-Stick USB-receiver for Integrated Wireless	1998 780	97.00

Integrated Wireless is intended to be sold in the EU only



0691 DIGI-MET® Indicators



Model

- Aluminium housing
- Outer ring (Bezel) Ø 60 mm
- Replacement probe tip M 2.5
- Protection class IP51
- Water and coolant resistant
- Clamping shank Ø 8 mm
- Display unit can be rotated through 270°
- LCD display with 11 mm high numerals
- Factory standard

Functions

- ON / OFF
- Set to zero at any point
- mm / inch switching
- PRESET-Function (setting a numerical value)
- Reversal of counting direction
- Data interface RS232 Proximity (cable no. 1998 760)

* Additional functions models 0691 751 + 0691 753

- TOL (tolerance value input)
- Factor input
- MIN / MAX
- TIR (MIN-MAX differential)

Delivery

- Cardboard box



0691 733



0691 735



0691 747



Marked	Marked	Measuring span		Resolution		Error limit	Order no.	List price
		mm	mm	mm	inch			
Reading 0.01 mm								
		12.5	0.01		.0005	0.01	0691 731	363.00
		25	0.01		.0005	0.01	0691 733	416.00
		50	0.01		.0005	0.02	0691 735	905.00
		100	0.01		.0005	0.02	0691 737	1020.00
Reading 0.001 mm								
		12.5	0.001		.00005	0.004	0691 741	448.00
		25	0.001		.00005	0.005	0691 743	491.00
		50	0.001		.00005	0.007	0691 745	1003.00
		100	0.001		.00005	0.008	0691 747	1158.00
Reading 0.001 mm. with additional functions*								
		12.5	0.001		.00005	0.003	0691 751	521.00
		25	0.001		.00005	0.004	0691 753	576.00



0701 Small dial gauges with lightweight plastic housing



Model

- Lightweight housing made of polyamide
- Measuring spindle is made of stainless steel
- Replacement probe tip M 2.5
- Clamping shank Ø 8 mm
- DIN 878

Delivery

- Fitted case

**DIN
878**

»	¼	Measuring span mm	Scale graduation value mm	Range per rev. mm	Outer ring (Bezel) Ø mm	Order no.	List price EUR
Small dial gauge							
		5	0.01	0.5	40	0701 101	40.00
Shockproof small dial gauge							
		5	0.01	0.5	40	0701 102	50.00

3

0708 Small dial gauges



0708 101



0708 102

Model

- Metal housing
- Measuring spindle is made of stainless steel
- Replacement probe tip M 2.5
- Clamping shank Ø 8 mm
- With a revolution counter
- DIN 878

Delivery

- Fitted case

**DIN
878**

»	¼	Measuring span mm	Scale graduation value mm	Range per rev. mm	Outer ring (Bezel) Ø mm	Order no.	List price EUR
		10	0.01	0.5	40	0708 101	86.00
		5	0.01	0.5	40	0708 102	55.00
		3	0.01	0.5	32	0708 103	66.00
		3	0.01	0.5	40	0708 104	45.00
Shockproof small dial gauge							
		3	0.01	0.5	40	0708 105	55.00
		5	0.01	0.5	40	0708 106	73.00



0701 Dial gauges



DIN
878



0701 106



0701 110

Model

- Measuring spindle is made of stainless steel
- Replacement probe tip M 2.5
- Clamping shank Ø 8 mm
- DIN 878
- 0701103 = Factory standard

Delivery

- Fitted case

⌘	¼	Measuring span mm	Scale graduation value mm	Range per rev. mm	Outer ring (Bezel) Ø mm	Order no.	List price EUR
		Dial gauge, plastic housing					
		10	0.01	1	58	0701 103	23.00
		Shockproof dial gauge, injection-moulded housing					
		10	0.01	1	56	0701 106	24.00
		Dial gauge, metal housing					
		10	0.01	1	58	0701 110	40.00
		Shockproof dial gauge, metal housing					
		10	0.01	1	58	0701 111	46.00

0703 Dial gauges with extended measuring range



0703 101

Model

- Metal housing
- Measuring spindle is made of stainless steel
- Replacement probe tip M 2.5
- Clamping shank Ø 8 mm
- With a concentric pointer
- Factory standard

Delivery

- Fitted case

⌘	¼	Measuring span mm	Scale graduation value mm	Range per rev. mm	Outer ring (Bezel) Ø mm	Order no.	List price EUR
		30	0.01	1	58	0703 101	99.00
		50	0.01	1	58	0703 104	137.00
		80	0.01	1	58	0703 107	275.00



0704 Shockproof dial gauges



0704 105



0704 109

Model

- Metal housing
- Measuring spindle is made of stainless steel
- Replacement probe tip M 2.5
- Clamping shank Ø 8 mm
- Shockproof

Delivery

- Fitted case

DIN 878

»	¼	Measuring span mm	Scale graduation value mm	Range per rev. mm	Outer ring (Bezel) Ø mm	Order no.	List price EUR
Revolution counter: DIN 878							
		10	0.01	1	58	0704 105	70.00
With fine adjustment of the pointer: DIN 878							
		10	0.01	1	58	0704 106	86.00
Concentric pointer: Factory standard							
		30	0.01	1	58	0704 109	113.00
		50	0.01	1	58	0704 110	146.00

3

0707 Water and oil proof dial gauges



0707 102

Model

- Metal housing, water and oil proof
- Protection class IP67
- Measuring spindle is made of stainless steel
- Replacement probe tip M 2.5
- Clamping shank Ø 8 mm
- Rubber belows
- Shockproof
- Outer ring (bezel) can be rotated through 360°
- DIN 878

Delivery

- Fitted case

DIN 878



»	¼	Measuring span mm	Scale graduation value mm	Range per rev. mm	Outer ring (Bezel) Ø mm	Order no.	List price EUR
		3	0.01	0.5	44.5	0707 101	124.00
		10	0.01	1	61.5	0707 102	106.00



0700 Dial gauges, graduation 0.1 mm



0700 102



0700 104

Model

- Metal housing
- Measuring spindle is made of stainless steel
- Replacement probe tip M 2.5
- Clamping shank Ø 8 mm
- Factory standard

Delivery

- Fitted case

⌘	¼	Measuring span	Scale graduation value	Range per rev.	Outer ring (Bezel)	Order no.	List price
		mm	mm	mm	Ø mm		EUR
		10	0.1	10	40	0700 100	60.00
		5	0.1	5	40	0700 101	60.00
		10	0.1	10	58	0700 102	46.00
Straight line revolution counter							
		30	0.1	10	58	0700 104	53.00

0702 Dial gauge with concentric mm display



0702 106

DIN
878

Model

- Metal housing
- Measuring spindle is made of stainless steel
- Replacement probe tip M 2.5
- Clamping shank Ø 8 mm
- With a concentric pointer
- DIN 878

Delivery

- Fitted case

⌘	¼	Measuring span	Scale graduation value	Range per rev.	Outer ring (Bezel)	Order no.	List price
		mm	mm	mm	Ø mm		EUR
		10	0.01	1	58	0702 106	61.00



0705 Precision dial gauges



0705 102

Model

- Metal housing
- Measuring spindle is made of stainless steel
- Replacement probe tip M 2.5
- Clamping shank Ø 8 mm
- With a revolution counter
- Factory standard

Delivery

- Fitted case

⌘	⌘	Measuring span mm	Scale graduation value mm	Range per rev. mm	Outer ring (Bezel) Ø mm	Order no.	List price EUR
		1	0.001	0.2	40	0705 102	108.00
		1	0.001	0.2	58	0705 104	108.00
		5	0.001	0.2	58	0705 105	113.00
Precision shockproof dial gauge							
		1	0.001	0.2	40	0705 107	115.00
		5	0.001	0.2	58	0705 109	140.00

3

0706 Error free, shockproof dial gauge



0706 102

Model

- Metal housing
- Measuring spindle is made of stainless steel
- Replacement probe tip M 2.5
- Clamping shank Ø 8 mm
- DIN 878

Delivery

- Fitted case

DIN
878

⌘	⌘	Measuring span mm	Scale graduation value mm	Dial reading	Overtravel mm	Outer ring (Bezel) Ø mm	Order no.	List price EUR
		0.8	0.01	40-0-40	1	58	0706 102	70.00



0709 Dial gauges with reverse action plunger



Model

- Metal housing
- Measuring spindle is made of stainless steel
- Replacement probe tip M 2.5
- Clamping shank \varnothing 8 mm
- Factory standard

Delivery

- Fitted case

✂	¼	Measuring span mm	Scale graduation value mm	Range per rev. mm	Outer ring (Bezel) \varnothing mm	Order no.	List price EUR
		3	0.01	0.5	40	0709 101	104.00
		5	0.01	1	58	0709 108	124.00

0712 Dial comparator gauge MICROTAST



0712 121



0712 124

Model

- Measuring spindle is made of hardened stainless steel
- Longer measuring spindle
- Replacement probe tip M 2.5
- Clamping shank \varnothing 8 mm
- Tolerance markers
- Shockproof
- Fine adjustment
- DIN 879

Delivery

- Fitted case

DIN
879

✂	¼	Measuring span mm	Scale graduation value mm	Dial reading	Overtravel mm	Order no.	List price EUR
		0.5	0.01	25-0-25	2.5	0712 121	149.00
		0.1	0.001	50-0-50	3	0712 124	182.00



0710 Magnetic back



Model

- For dial gauges with outer ring (Bezel) Ø 58 mm
- Allows dial gauges to be used without a holder or a stand
- Magnetic force 220 N
- Cannot be used in conjunction with dial gauges 0701 103 and 0701 106 or any digital gauges

»»	¼	Order no.	List price EUR
		0710 101	51.00

0710 Lug back

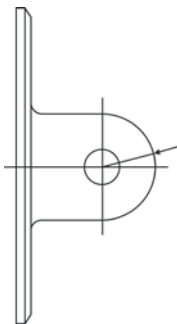

Model

- Ø 5 mm
- For retrofitting
- Cannot be used in conjunction with dial gauges 0701 103 and 0701 106 or any digital gauges

»»	¼	Diameter	Order no.	List price EUR
For dial gauges with an outer ring (Bezel) dia. 40 mm				
		5 mm	0710 102	6.30
For dial gauges with an outer ring (Bezel) dia. 58 mm				
		5 mm	0710 103	6.50

0710 Spindle lifting lever

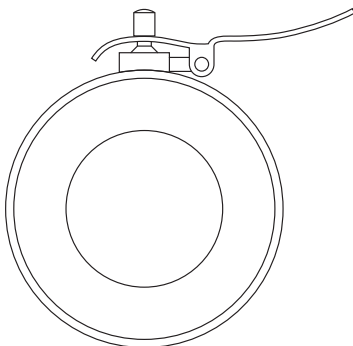

Model

- For dial gauges with a measuring range max. 10 mm
- Cannot be used in conjunction with dial gauges 0701 103 and 0701 106 or any digital gauges

»»	¼	Order no.	List price EUR
For dial gauges with an outer ring (Bezel) dia. 40 mm			
		0710 104	10.10
For dial gauges with an outer ring (Bezel) dia. 58 mm			
		0710 105	10.10



0724 Angle lever attachment



Model

- Clamping shank \varnothing 8 mm
- Smallest measurable hole: 6 mm

Delivery

- Excludes dial gauge

⌘	¼	Measuring depth mm	Order no.	List price EUR
		60	0724 101	46.00

0710 Extensions for dial gauges



Model

- Special steel
- Thread M 2,5

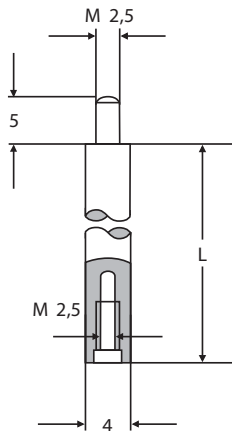

⌘	¼	Length mm	Order no.	List price EUR
		10	0710 111	4.30
		15	0710 112	4.30
		20	0710 113	4.30
		25	0710 114	4.30
		30	0710 115	4.30
		35	0710 116	4.30
		40	0710 117	4.30
		45	0710 118	4.30
		50	0710 119	4.30
		55	0710 120	4.30
		60	0710 121	4.30
		65	0710 122	4.30
		70	0710 123	4.30
		75	0710 124	4.30
		80	0710 125	4.30
		85	0710 126	4.30
		90	0710 127	4.30
		95	0710 128	4.30
		100	0710 129	4.30



0710 Measuring inserts M 2.5

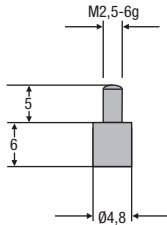

Material	Length mm	Order no.	List price EUR
Special steel	6	0710 161	3.50
Carbide	6	0710 261	23.80

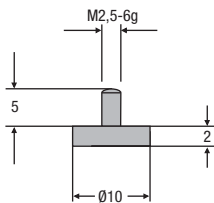

Material	Length mm	Order no.	List price EUR
Special steel	2	0710 162	4.50
Carbide	2	0710 262	38.40

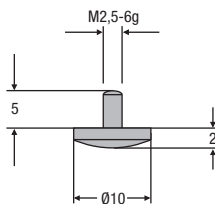

Material	Length mm	Order no.	List price EUR
Special steel	2	0710 163	5.20
Carbide	2	0710 263	46.30

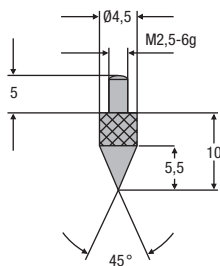

Material	Length mm	Order no.	List price EUR
Special steel	10	0710 164	5.20
Carbide	10	0710 264	44.80

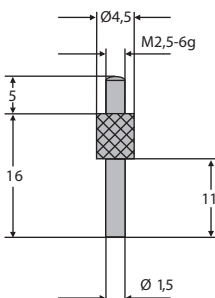

Material	Length mm	Diameter mm	Order no.	List price EUR
Special steel	16	1.5	0710 165	6.50
Carbide	16	1.5	0710 265	20.60



0710 Measuring inserts M 2.5

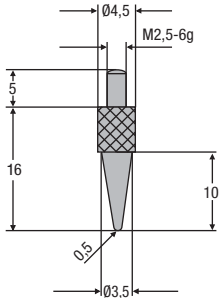

☒	☒	Material	Length mm	Order no.	List price EUR
		Special steel	16	0710 166	4.70

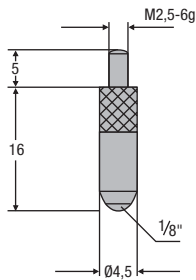

☒	☒	Material	Length mm	Order no.	List price EUR
		Special steel	16	0710 167	3.30
		Carbide	16	0710 267	10.90
		Ruby	16	0710 367	8.50
		Sapphire	16	0710 467	8.50

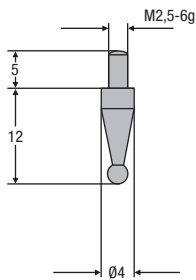

☒	☒	Material	Length mm	Ball diameter mm	Order no.	List price EUR
Tolerance of the ball diameter +/- 1 µm						
		Special steel	12	1	0710 169	6.50
		Special steel	12	1.5	0710 170	6.50
		Special steel	12	2	0710 171	6.50
		Special steel	12	2.5	0710 172	6.50
		Special steel	12	3	0710 173	6.50
		Special steel	12	3.5	0710 174	6.50
		Special steel	12	4	0710 175	6.50
		Special steel	12	4.5	0710 176	6.50
		Special steel	12	5	0710 177	6.50
		Special steel	12	5.5	0710 178	6.50
		Special steel	12	6	0710 179	6.50
		Special steel	12	6.5	0710 180	6.50

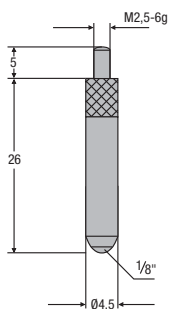

☒	☒	Material	Length mm	Order no.	List price EUR
		Special steel	26	0710 168	3.30
		Carbide	26	0710 268	10.90
		Ruby	26	0710 368	8.50
		Sapphire	26	0710 468	8.50



0710 Measuring inserts M 2.5

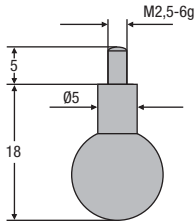

Material	Length mm	Ball diameter mm	Order no.	List price EUR
Special steel	18	7	0710 181	6.50
Special steel	18	7.5	0710 182	6.50
Special steel	18	8	0710 183	6.50
Special steel	18	8.5	0710 184	6.50
Special steel	18	9	0710 185	6.50
Special steel	18	9.5	0710 186	6.50
Special steel	18	10	0710 187	6.50
Special steel	18	10.5	0710 188	6.50
Special steel	18	11	0710 189	6.50

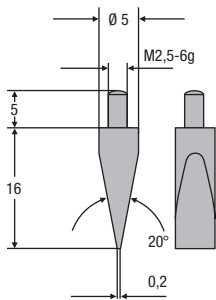

Material	Length mm	Order no.	List price EUR
with locknut			
Special steel	16	0710 192	6.90
Carbide	16	0710 292	48.70

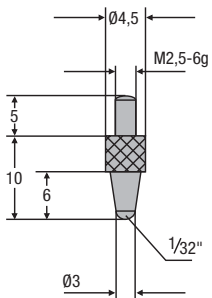

Material	Length mm	Order no.	List price EUR
Special steel	10	0710 193	3.50

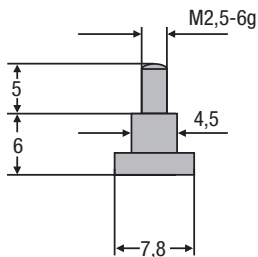

Material	Length mm	Order no.	List price EUR
Special steel	6	0710 194	4.70



0710 Measuring inserts M 2.5

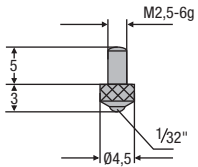

Material	Length mm	Order no.	List price EUR
Special steel	3	0710 195	1.10

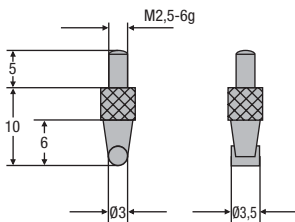

Material	Length mm	Diameter mm	Order no.	List price EUR
with locknut				
Special steel	10	3 x 3.5	0710 196	7.60

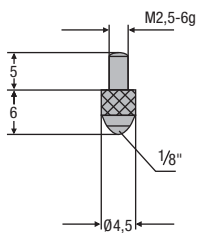

Material	Length mm	Order no.	List price EUR
Special steel	6	0710 197	1.10
Carbide	6	0710 297	4.50
Ruby	6	0710 397	6.10
Sapphire	6	0710 497	6.10



0715 Dial test indicators



0715 101



0715 201

Model

- Carbide tipped measuring inserts, Ø 2.0 mm
- Form A in accordance to DIN 2270
- Revolving dial
- 3-piece swallow tail guide
- Automatic reversal of the counting direction
- Measuring force 0.15 N

Delivery

- Fitted case

DIN
2270

⊗	☒	Measuring range mm	Scale graduation value mm	Range per rev. mm	Stylus length mm	Dial reading	Outer ring (Bezel) Ø mm	Order no.	List price EUR
		± 0.4	0.01	0.8	14.5	0-40-0	30	0715 101	77.00
		± 0.4	0.01	0.8	14.5	0-40-0	40.5	0715 103	86.00
		± 0.25	0.01	0.5	41.2	0-25-0	30	0715 201	121.00
		± 0.1	0.002	0.2	14.5	0-100-0	40.5	0715 303	108.00
		± 0.1	0.002	0.2	14.5	0-100-0	30	0715 305	103.00
		± 0.5	0.01	0.5	32.3	0-50-0	40.5	0715 307	154.00

0715 Clamping shanks for dial test indicators

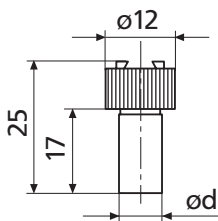

Model

- With swallow tail mounting for dial test indicators and clamping nut

⊗	☒	Diameter	Order no.	List price EUR
		4h6	0715 903	11.60
		8h6	0715 907	11.60

0715 Measuring inserts with carbide ball

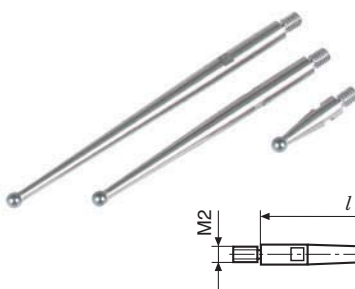

⊗	☒	Length mm	Ball diameter mm	Order no.	List price EUR
		14.5	1	0715 915	16.20
		14.5	2	0715 917	12.80
		14.5	3	0715 919	12.80
		32.3	1	0715 921	17.90
		32.3	2	0715 922	13.50
		32.3	3	0715 923	13.40
		41.2	1	0715 925	16.40
		41.2	2	0715 926	12.80
		41.2	3	0715 929	12.80



0715 Key for measuring inserts



⌘	⚙	Order no.	List price EUR
		0715 940	2.40

0715 Universal clamp

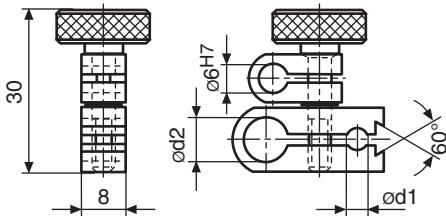

⌘	⚙	Diameter mm	Order no.	List price EUR
		8	0715 950	24.30

0715 Holder

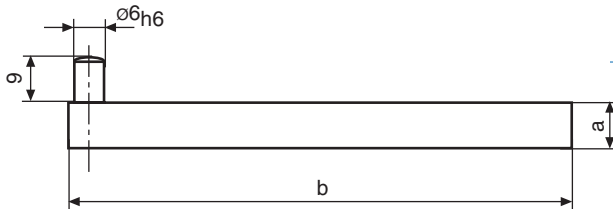

⌘	⚙	Length mm	Cross-section mm	Order no.	List price EUR
		100	9 x 9	0715 955	15.40



0716 Dial depth gauges with a measuring base



0716 101



0716 111

Model

- Measuring base is made of stainless steel, hardened
- Replacement probe tip M 2.5
- Revolving dial
- Factory standard

Delivery

- Cardboard box

⌘	⊘	Measuring range mm	Reading mm	Contact surface mm	Range per rev. mm	Scale dia. mm	Order no.	List price EUR
		0 - 10	0.01	100 x 15	1	58	0716 101	134.00
Concentric pointer								
		0 - 30	0.01	150 x 15	1	58	0716 102	196.00
		0 - 30	0.01	100 x 15	1	58	0716 105	176.00
Prismatic base								
		0 - 30	0.01	10 x 100	1	58	0716 111	259.00

3

0716 Depth measuring base for indicators



0716 192

Model

- Special steel, chrome plated
- Mounting for indicator Ø 8 mm

Delivery

- Cardboard box

⌘	⊘	Contact surface mm x mm	Order no.	List price EUR
		80 x 15	0716 192	57.00
		100 x 15	0716 194	70.00
		150 x 15	0716 196	90.00



0718 Dial thickness gauges



0718 101



0718 112



Model

- Frame is made of aluminium alloy
- Factory standard
- When ordering please specify the gauge form

Delivery

- Cardboard box

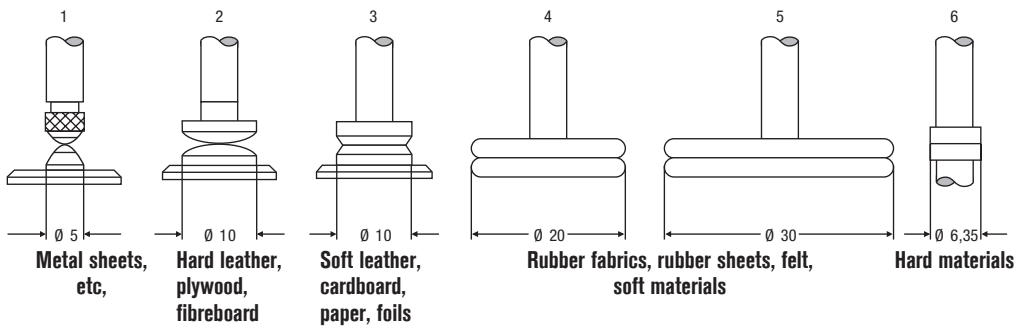

⊗	⊗	Measuring range mm	Reading mm	Frame depth mm	Probe type	Order no.	List price EUR
		0 - 10	0.1	15	1 / 2 / 3 / 6	0718 101	48.90
		0 - 20	0.1	50	1 - 5	0718 104	102.00
		0 - 30	0.1	50	1 - 5	0718 105	115.00
		0 - 50	0.1	50	1 - 5	0718 106	175.00
With a lifting device and stand. range per revolution 10 mm							
		0 - 30	0.1	200	1 - 5	0718 108	150.00
		0 - 30	0.1	300	1 - 5	0718 109	172.00
		0 - 30	0.1	400	1 - 5	0718 110	192.00
With a lifting wheel and concentric pointers. range per revolution 1 mm							
		0 - 10	0.01	18	1 / 2 / 3 / 6	0718 112	97.00
		0 - 10	0.01	45	1 / 2 / 3 / 6	0718 113	111.00
With a lifting device. range per revolution 1 mm							
		0 - 10	0.01	50	1 - 5	0718 115	115.00



0720 Dial thickness gauges



0720 102



0720 103

3

Model

- With a lifting device
- Factory standard
- Frame is made of alluminium alloy
- Revolution counter

- **Order No. 0720 102**
Tube wall thickness dial gauge with 2 exchangeable probes
- with bund radius = 10 mm, dia, 8 mm
- cylindrical dia. 6 mm
- **Order No. 0720 103**
Foil thickness measuring gauge, measuring insert dia. 6.35 mm. flat. thermally insulated

Delivery

- Cardboard box

»	¼	Measuring range mm	Reading mm	Range per rev. mm	Frame depth mm	Order no.	List price EUR
Foil thickness dial gauge							
		0 - 1	0.001	0.2	30	0720 103	218.00
Tube wall thickness dial gauge							
		0 - 10	0.01	1	50	0720 102	153.00



0721 Internal caliper gauges



0721 120

Model

- Protection class IP65

Delivery

- Cardboard box

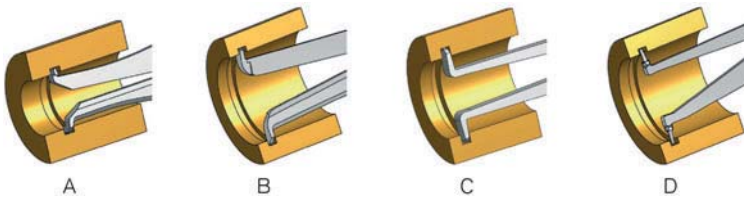

✕	¼	Measuring range mm	Measuring depth mm	Reading mm	Error limit mm	For grooves		Order no.	List price EUR
						max. depth	min. width		
Contact point type „A“, cutting (chisel) radius 0.1 mm									
		2.5 - 12.5	12	0.005	0.015	0.7	0.6	0721 100	491.00
Contact point type „B“, carbide ball Ø 0.6 mm									
		5 - 15	35	0.005	0.015	2.2	0.8	0721 101	491.00
Contact point type „B“, carbide ball Ø 1.0 mm									
		10 - 30	85	0.01	0.03	5.2	1.2	0721 120	509.00
Contact point type „C“, carbide ball Ø 1.0 mm									
		20 - 40	85	0.01	0.03	7	1.2	0721 121	509.00
		30 - 50	85	0.01	0.03	7	1.2	0721 122	509.00
Contact point type „D“, carbide ball Ø 1.0 mm									
		40 - 60	85	0.01	0.03	8.3	1.2	0721 123	509.00
		50 - 70	85	0.01	0.03	8.3	1.2	0721 124	526.00
		60 - 80	85	0.01	0.03	8.3	1.2	0721 125	526.00
		70 - 90	85	0.01	0.03	8.3	1.2	0721 126	526.00
		80 - 100	85	0.01	0.03	8.3	1.2	0721 127	526.00



0721 External caliper gauges



0721 144

Model

- Protection class IP65

Delivery

- Cardboard box

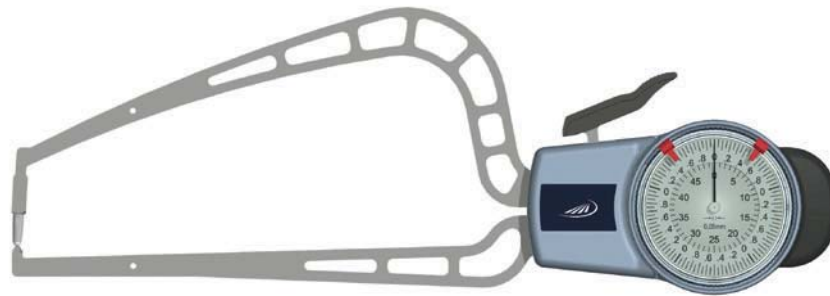

0721 149

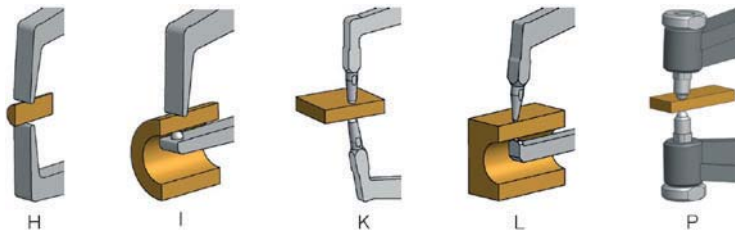

»	¼	Measuring range mm	Measuring depth mm	Reading mm	Error limit mm	Contact point length		Order no.	List price EUR
						moving mm	fixed mm		
Contact point type „P“, carbide ball Ø 5.0 mm									
		0 - 10	36	0.1	0.1	5	5	0721 140	139.00
Contact point type „H“, cutting chisel radius 0.4 mm									
		0 - 10	35	0.005	0.015	18.8	18.8	0721 141	491.00
Contact point type „I“, fixed arm, carbide ball Ø 1.5 mm, moving arm, cutting (chisel) radius R = 0.4 mm									
		0 - 10	35	0.005	0.015	18.8	0.9	0721 142	491.00
Contact point type „K“, carbide ball Ø 1.5 mm									
		0 - 10	35	0.005	0.015	19.1	18.6	0721 143	491.00
		0 - 20	85	0.01	0.03	24.6	24.6	0721 144	491.00
Contact point „L“ carbide ball Ø 1.5 mm, 1 straight probe arm									
		0 - 20	80	0.01	0.03	24.7	2.5	0721 145	491.00
Contact point type „K“, carbide ball Ø 3.0 mm									
		0 - 50	167	0.05	0.05	30	30	0721 148	748.00
Contact point „L“ carbide ball Ø 3.0 mm, 1 straight probe arm									
		0 - 50	169	0.05	0.05	30	4.6	0721 149	748.00

3



0721 Digital internal caliper gauges



0721 732



0721 738

Model

- Protection class IP67

Functions

- ON / OFF
- Set to zero at any point
- mm / inch switching
- PRESET-Function (setting a numerical value)
- TOL (tolerance value input)
- Data output

Delivery

- Cardboard box

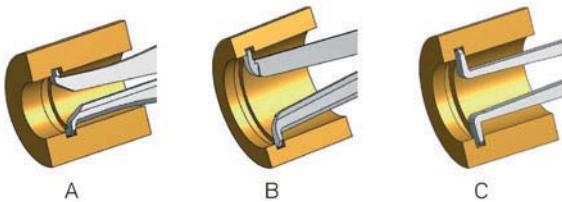

A

B

C

✕	%	Measuring range	Measuring depth	Reading	Error limit	For grooves		Order no.	List price
		mm	mm			max. depth mm	min. width mm		
Contact point type „B“, carbide ball Ø 0.6 mm									
		5 - 15	35	0.005	0.015	2.3	0.8	0721 731	526.00
Contact point type „C“, carbide ball Ø 1.0 mm									
		10 - 30	85	0.01	0.03	5.2	1.2	0721 732	526.00
		20 - 40	85	0.01	0.03	7	1.2	0721 733	526.00
		30 - 50	85	0.01	0.03	7	1.2	0721 734	526.00
Contact point type „C“, carbide ball Ø 1.3 mm									
		13 - 43	127	0.02	0.04	5.7	1.6	0721 738	670.00
Contact point type „D“, carbide ball Ø 2.0 mm									
		50 - 80	132	0.02	0.04	8.3	2.4	0721 739	670.00
Contact point type „C“, carbide ball Ø 1.5 mm									
		15 - 65	188	0.02	0.06	5.5	1.9	0721 740	925.00



0721 Digital external caliper gauges



0721 745

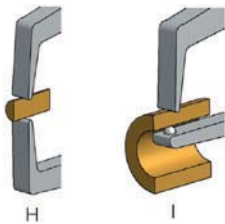

Functions

- ON / OFF
- Set to zero at any point
- mm / inch switching
- PRESET-Function (setting a numerical value)

- ABS (display can be set to zero without losing the Preset value)
- TOL (tolerance value input)
- Data output

Delivery

- Cardboard box

»	¼	Measuring range mm	Measuring depth mm	Reading mm	Error limit mm	Contact point length moving	Contact point length fixed	Order no.	List price EUR
Contact point type „K“, carbide ball Ø 1.5 mm									
		0 - 20	85	0.01	0.03	24.6	24.6	0721 741	526.00
Contact point type „K“, carbide ball Ø 3.0 mm									
		0 - 30	116	0.02	0.04	30	30	0721 745	670.00
		0 - 50	167	0.02	0.05	30	30	0721 747	925.00
Contact point „L“ carbide ball Ø 3.0 mm, straight lower probe arm									
		0 - 30	116	0.02	0.04	30	4	0721 746	670.00

0721 Accessories for caliper gauges



0721 785

»	¼	Description	Order no.	List price EUR
		Data interface (adapter and cable) for Digimatic	0721 785	140.00
		Data interface (adapter and cable) for USB	0721 786	140.00

When placing an order, please specify the order no. and the type of the caliper gauge.



0724 Internal bore gauges for blind holes



Model

- 2 point comparator measuring instrument for measuring at the bottom of the bore
- Holder, measuring slides and contact pin carbide tipped
- Mounting hole \varnothing 8 mm
- Ideal in conjunction with dial gauges or dial comparator gauges

Delivery

- Wooden case
- Excludes dial gauge

NEW

✕	⚙	Measuring range mm	Front distance mm	Order no.	List price EUR
		20 - 50	1.5	0724 504	895.00
		50 - 110	1.5	0724 508	870.00
		110 - 300	2	0724 522	1215.00
		300 - 600	2	0724 530	2675.00

0724 Holder for internal bore gauges 0724



✕	⚙	For measuring range mm	Order no.	List price EUR
		20 - 50	0724 904	750.00
		50 - 110	0724 908	775.00
		110 - 300	0724 922	895.00
		300 - 600	0724 930	1180.00



0726 Internal precision bore gauges, set for smaller bores



0726 310

Model

- 2 point comparator measuring instrument with split probe + measuring pin
- Excludes a dial gauge
- Without setting ring
- Mounting hole Ø 8 mm
- Ideal in conjunction with dial gauges or dial comparator gauges

Delivery

- Wooden case
- Excludes dial gauge

»	¼	Effective measuring range mm	Nominal meas. range mm	Measuring depth mm	Number of measuring probes pcs	Order no.	List price EUR
Hardened chrome finished probe							
		4.15 - 7.8	4.5 - 7.5	41	7	0726 310	665.00
		7.7 - 12.5	8.0 - 12.0	45	6	0726 311	681.00
		4.15 - 12.5	4.5 - 12.0	41	13	0726 312	1081.00
		12.2 - 20.6	13.0 - 20.0	45	8	0726 313	779.00
Carbide tipped probe							
		0.95 - 1.55	1.0 - 1.4	13	5	0726 500	670.00
		1.5 - 4.2	1.75 - 4.0	17	10	0726 501	956.00
		0.95 - 4.2	1.0 - 4.0	13	15	0726 502	1486.00
		4.15 - 7.8	4.5 - 7.5	41	7	0726 510	1018.00
		7.7 - 12.5	8.0 - 12.0	45	6	0726 511	971.00
		4.15 - 12.5	4.5 - 12.0	41	13	0726 512	1818.00
		12.2 - 20.6	13.0 - 20.0	45	8	0726 513	1122.00

0726 Accessories for 0726

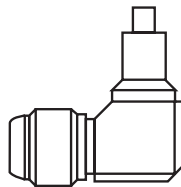
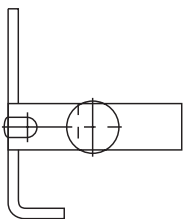

»	¼	For measuring range mm	Order no.	List price EUR
Clamp with depth stop				
		1 - 4	0726 122	143.00
		4.5 - 9	0726 123	131.00
		10 - 20	0726 124	124.00
Angle probe 90°				
		1 - 20	0726 130	227.00

0726 Set of setting rings

»	¼	For measuring range mm	Number of devices pcs	Order no.	List price EUR
		1 - 1.4	5	0726 300	292.00
		8 - 12	6	0726 301	293.00
		1 - 4	15	0726 302	930.00
		4.5 - 12	13	0726 303	660.00
		13 - 20	8	0726 304	410.00
		1.75 - 4	10	0726 305	504.00
		4.5 - 7.5	7	0726 306	327.00



0728 Internal precision bore gauges for large and deep bores



Model

- 2 point comparator measuring instrument with split probe + measuring pin
- Centering plate
- Mounting hole Ø 8 mm
- Ideal in conjunction with dial gauges or dial comparator gauges

Delivery

- Wooden case
- Excludes dial gauge



✕	¼	Measuring range mm	Repeatability µm	Measuring depth mm	Measuring pins pcs	Measuring discs pcs	Order no.	List price EUR
Fixed measuring pins, hardened special steel, interchangeable contact pins carbide tipped								
		18 - 35	0.5	110	9	2	0728 105	379.00
		35 - 60	0.5	138	7	2	0728 106	369.00
		50 - 100	0.5	177	11	3	0728 107	421.00
		100 - 160	0.5	234	7	4	0728 108	587.00
		160 - 290	0.5	234	7	4	0728 109	847.00
		280 - 510	1.5	400	7	4	0728 110	2000.00
Fixed measuring pins and interchangeable contact pins, both pins are carbide tipped								
		4.5 - 6	0.5	80	9	-	0728 201	966.00
		6 - 8	0.5	100	7	-	0728 202	691.00
		8 - 12	0.5	100	9	-	0728 203	644.00
		12 - 20	0.5	110	9	1	0728 204	447.00
		18 - 35	0.5	110	9	2	0728 205	452.00
		35 - 60	0.5	138	7	2	0728 206	431.00
		50 - 100	0.5	177	11	3	0728 207	504.00
		100 - 160	0.5	234	7	4	0728 208	655.00
		160 - 290	0.5	234	7	4	0728 209	868.00
		280 - 510	1.5	400	7	4	0728 210	2047.00

0728 Setting device for internal precision bore gauges



Model

- Setting device for accurate adjustment of internal precision bore gauges to the required nominal dimension, with gauge blocks
- The setting jaws are made of carbide and are lapped to gauge block quality
- Setting device can be used in both, the vertical and horizontal measuring axis

Delivery

- Wooden case
- Incl. stand (excludes gauge blocks)

✕	¼	For measuring range mm	Error limit µm	Order no.	List price EUR
		4.5 - 160	2	0728 910	1195.00
		18 - 290	2	0728 915	1184.00
		160 - 510	2	0728 920	1714.00



0735 Crankshaft gauges

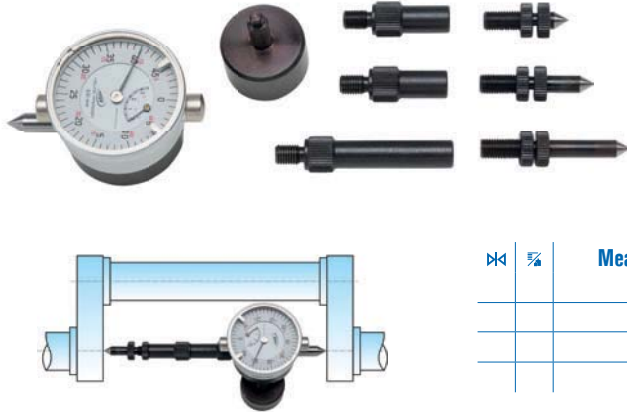

Model

- With dial gauge
- To be positioned between 2 crank arms
- Centre punch is not required
- Horizontal position of the dial gauge is assured with a plumb bob

Delivery

- Wooden case

»	¼	Measuring range mm	Reading mm	Order no.	List price EUR
		45 - 150	0.01	0735 101	392.00
		60 - 300	0.01	0735 102	353.00
		60 - 500	0.01	0735 103	410.00

0735 Replacement gauge for 0735

Model

- For order no. 0735 102 and 0735 103

»	¼	Order no.	List price EUR
		0735 902	179.00

0736 Length measuring instruments for external incisions

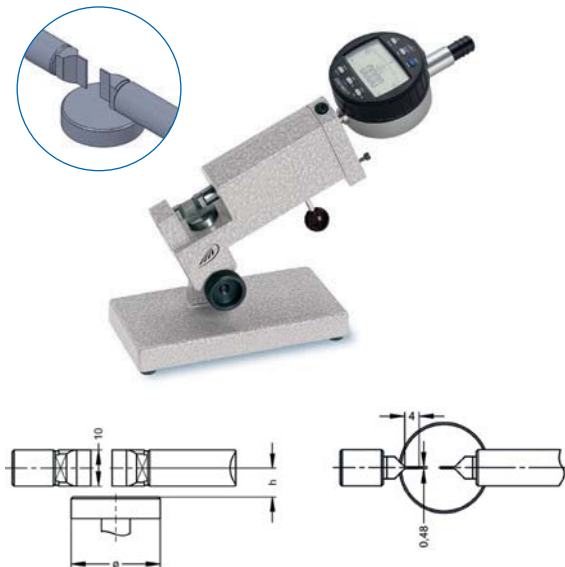

Model

- Ideal for serial measurements of incision diameters on turned parts
- Narrow measuring faces
- High precision ball guide of the transmission bolt
- Round support table, height adjustable, clamped for setting the exact measuring position
- Heavy stand
- Base unit in the angular grid 0° / 30° / 60° / 90°
- Titled and clamped
- Support for indicators with shaft Ø 8 mm
- Display devices: analogue and digital indicators

- Versions with other measuring inserts are available upon request

Delivery

- Cardboard box
- Without digital indicator (optional)

»	¼	Measuring range mm	Size of table dia. mm	Dimensions h mm	Order no.	List price EUR
		0 - 10	25 mm	8	0736 101	904.00
		0 - 25	38 mm	13	0736 102	975.00
		25 - 50	50 mm	35	0736 103	1044.00



0737 Length measuring instrument for internal incisions

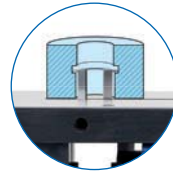

Model

- Ideal for serial measurements of internal incision diameters
- High precision probe guidance with a constant measuring force
- Adjust the height with a gauge block
- Set the diameter with a setting ring
- Measuring table plate size 110 x 73 mm
- Mounting hole \varnothing 8 mm
- Ideal for analogue and digital dial gauges as well as electronic probes
- Optional angled probes made of hardened steel

Delivery

- Cardboard box
- Without indicator (optional)
- Without pair of measuring probes (optional)

		Measuring range internal mm	Order no.	List price EUR
		4 - 56	0737 101	880.00

0737 Measuring probes (pair) made of hardened steel for 0737

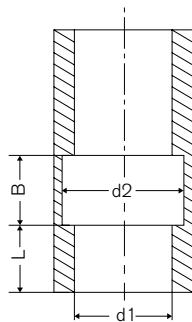

	For bore dia. „d1“ mm	Adjustable meas. height „L“ mm	Min. groove width „B“ mm	Max. incision dia. „d2“ mm	Order no.	List price EUR
	4 - 28	0 - 8	0.74	d1 + 2	0737 121	87.00
	6.5 - 30	0 - 10	1.00	d1 + 4	0737 122	87.00
	13 - 38	0 - 18	1.20	d1 + 2	0737 123	87.00
	20.5 - 51	0 - 25	1.20	d1 + 4	0737 124	87.00



0739 Universal comparator gauge

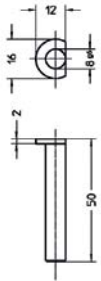

0739 124

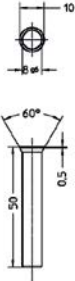

0739 126

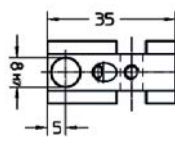

0739 164

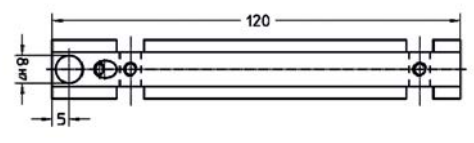

0739 165

Model

- To determine internal and external diameters of recesses, grooves and undercuts in comparison measurement
- Measurement procedure: The part to be measured is determined at the point of reversal between a fixed and moveable measuring insert
- Select either an analogue or digital indicator to show your measuring results
- Sturdy construction
- Simple to set up and easy to operate
- Large range of application
- Ideal for serial measurements
- Optional: Special supporting table is interchangeable

- Repeatability: 2 µm
- Mounting hole for a dial gauge: Ø 8 mm

Delivery

- Without digital indicator (optional)
- Incl. Pair of measuring inserts 0739 126 and 0739 124
- Incl. holder for measuring inserts 0739 164 and 0739 165
- In a practical aluminium case

Measuring range	Base dimensions	Order no.	List price	
				external mm
0 - 180	21 - 200	150 x 150 x 68	0739 102	1708.00



0739 Measuring probes



0739 124

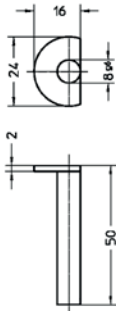

0739 125

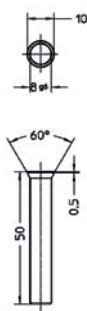

0739 126

⌘	¼	Description	Order no.	List price EUR
		Probe pair	0739 124	103.00
		Probe pair	0739 125	107.00
		Probe pair	0739 126	61.00
		Pair of probe holders	0739 127*	98.00
		Pair of probe holders	0739 128*	61.00
		Pair of probe holders	0739 129*	118.00
		Probe pair	0739 130	99.00
		Small probe pair	0739 131**	107.00
		Holder pair for 0739131	0739 132	142.00

* For further information regarding probes Ref. No. 0739 127 to 0739 129 see Ref. No. 0710 starting on page 137

** Required holder No. 0739 132

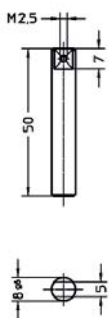

0739 127

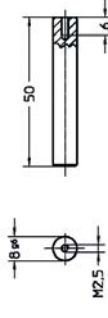

0739 128

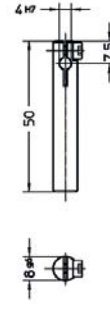

0739 129

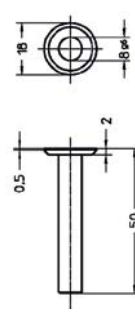

0739 130

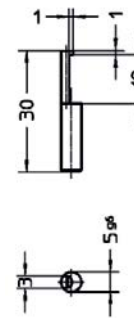

0739 131



0739 132

Application examples:

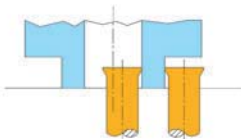

0739 126

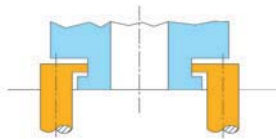

0739 124

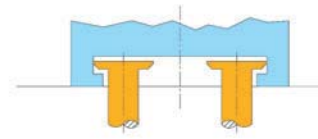

0739 130

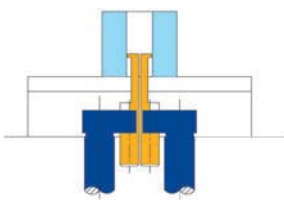

0739 131

0739 132

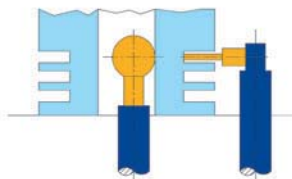

0739 127*

0739 128*

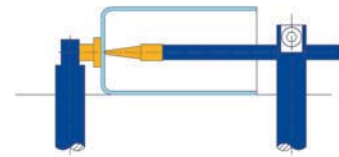

0739 129*

0739 129*



0739 Holder for measuring inserts short / long

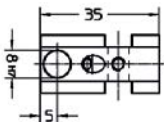

0739 164

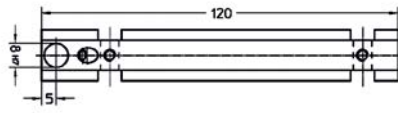

0739 165

Description	Length mm	Order no.	List price EUR
Holder, short	35	0739 164	37.00
Holder, long	120	0739 165	45.70

0739 Large supporting table

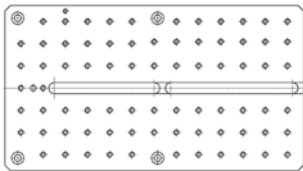

Model

- Made of special steel with wear resistant surface coating
- Equipped with thread bore M5 in grid to attach stop elements
- Internal measurement: 21 - 220 mm
- External measurement: 0 - 300 mm

Delivery

- With leg support to screw

Size of table mm	Order no.	List price EUR
269 x 149	0739 170	183.00

0739 Stop pieces

Description	Length mm	Width mm	Diameter mm	Dimensions h mm	Order no.	List price EUR
Stop cuboid	60	16		16	0739 121	87.00
Stop disc			24	16	0739 122	99.00
Stop stepped cuboid	60	25		16	0739 123	90.00

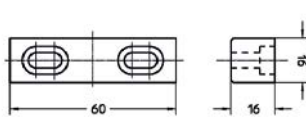

0739 121

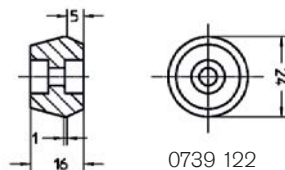

0739 122

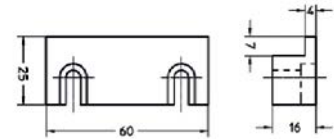

0739 123

Application examples:

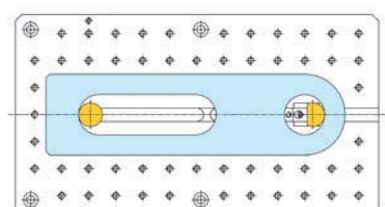
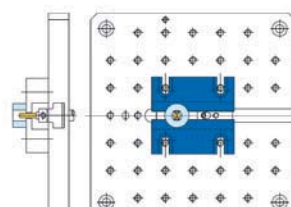
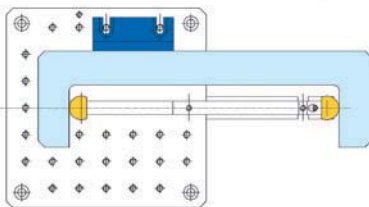
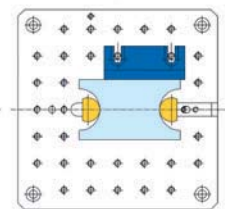
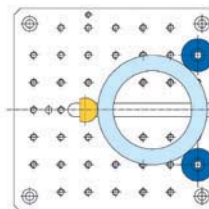
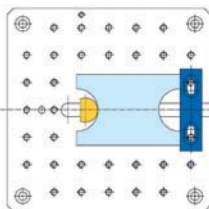
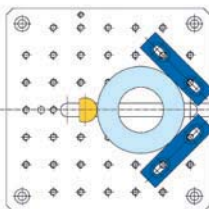



0741 Universal comparator gauge UHRTAST





0741 Comparator gauge UHRTAST



Model

- Comparator gauge for **external and internal measurements** for checking workpieces and setting of machines
- Versatile in use due to wide range of probes and inserts
- Measuring range up to 2000 mm by using optional extensions
- Without indicator
- The direction of the measuring force can be switched, the gauge can be used for external and internal measurements
- The adjustment can be conducted with a setting gauge, a combination of gauge blocks, setting ring or a micrometer
- The measuring range of the moveable measuring arm is 18 mm

Delivery

- Wooden case
- Basic instrument without digital indicator, measuring arms and measuring probes (optional)



Product video

	Measuring range		Measuring force	Order no.	List price
	external mm	internal mm	N		EUR
	5 - 220	15 - 230	10	0741 101	1787.00

0741 Pair of probe mounting block

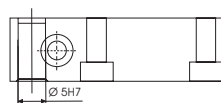

	Order no.	List price
		EUR
	0741 170	164.00

0741 Extensions



Model

- Combinable with the basic instrument and further extensions by sticking together the pipe construction



0741 112



0741 114

	Length mm	Order no.	List price
			EUR
	100	0741 112	249.00
	200	0741 114	264.00
	500	0741 116	403.00



0741 Measuring inserts



0741 178

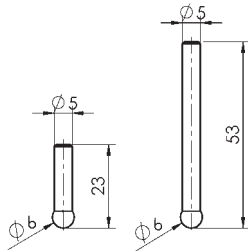

✕	¼	Length mm	Diameter mm	Order no.	List price EUR
		23	6	0741 178	110.00
		53	6	0741 179	110.00

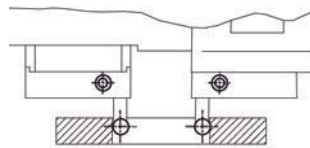

0741 Measuring inserts

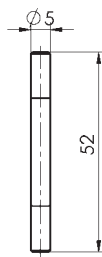

✕	¼	Length mm	Diameter mm	Order no.	List price EUR
		52	5	0741 180	110.00

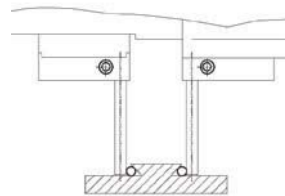

0741 Pair of offset measuring inserts

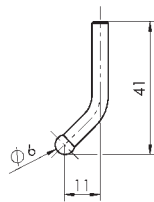

✕	¼	Length mm	Diameter mm	Order no.	List price EUR
		41	6	0741 182	183.00

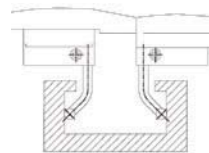

0741 Pair of measuring inserts with discs



✕	¼	Length mm	Width mm	Diameter mm	Dimensions h mm	Order no.	List price EUR
		42	10.5	12	2	0741 176	110.00

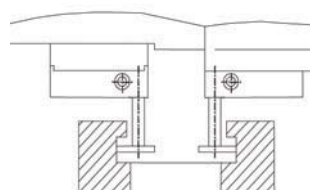
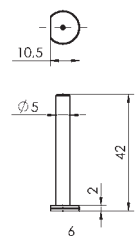



0741 Measuring inserts

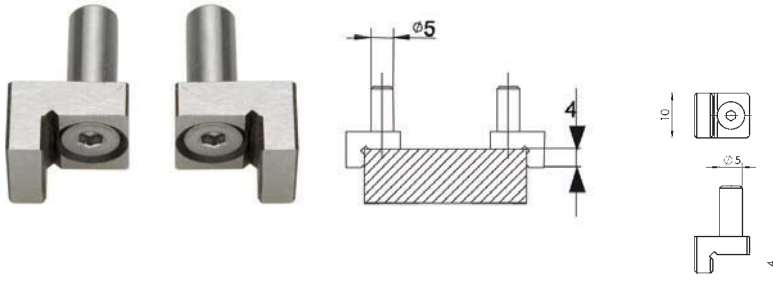

Model

- For measuring external central points

Order no.	List price EUR
0741 172	196.00

0741 Pair of shoulder measuring inserts

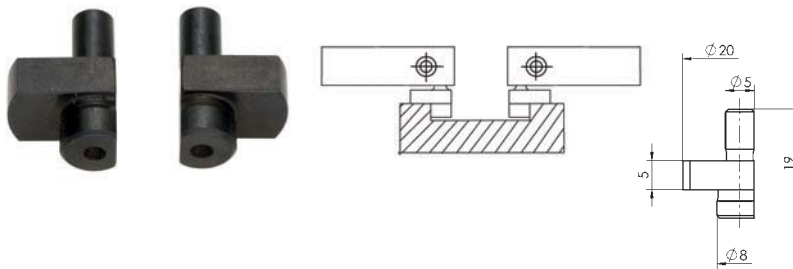

Model

- For measuring internal central points

Order no.	List price EUR
0741 174	160.00

0741 Pairs of thread measuring inserts for metric external thread

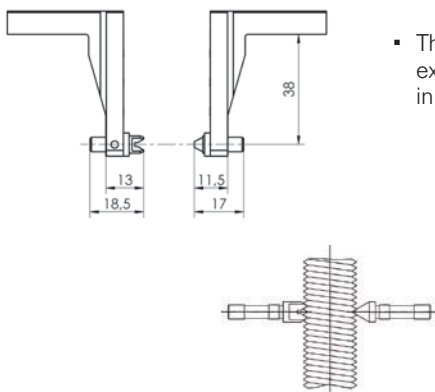

Model

- Thread measuring inserts for external thread, metric pitch in pairs

Thread pitch mm	Order no.	List price EUR
0.35	0741 140	184.00
0.4 - 0.45	0741 141	104.00
0.5 - 0.6	0741 142	104.00
0.7 - 0.8	0741 143	104.00
1.0 - 1.25	0741 144	104.00
1.5 - 1.75	0741 145	104.00
2.0 - 2.5	0741 146	104.00
3.0 - 3.5	0741 147	104.00
4.0 - 5.0	0741 148	104.00
5.5 - 6.0	0741 149	104.00

0741 Pairs of thread measuring inserts for metric internal thread

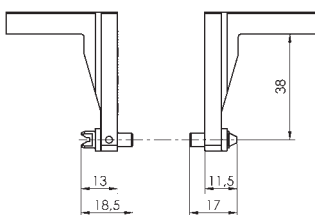

Model

- Thread measuring inserts for internal thread, metric pitch in pairs

Thread pitch mm	Order no.	List price EUR
1.0 - 1.25	0741 163	210.00
1.5 - 1.75	0741 164	210.00
2.0 - 2.5	0741 165	210.00
3.0 - 3.5	0741 166	210.00
4.0 - 5.0	0741 167	210.00
5.5 - 6.0	0741 168	210.00



0741 Pairs of measuring arms

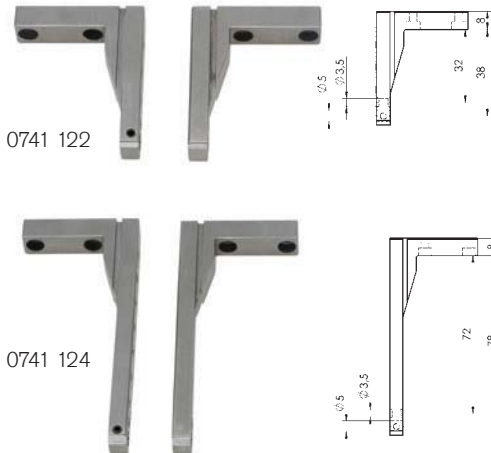

Model

- For mounting of adapter pieces and inserts with shaft- \varnothing 5 mm and \varnothing 3.5
- With lasered help rule (mm-divide) as position help for the depth stop pieces

Marked	Length mm	Order no.	List price EUR
	40	0741 122	259.00
	80	0741 124	311.00

0741 Pair of depth stop attachment for measuring arms



Model

- To slide on measuring arms
- Can be clamped with grub screw

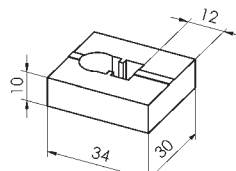

Marked	Length mm	Width mm	Height mm	Order no.	List price EUR
	34	30	10	0741 136	241.00

0741 Pair of adapters 5 mm for measuring inserts M2.5



Model

- All measuring inserts for dial gauges with M2.5 can be used (measuring inserts please refer to pages 137-140)

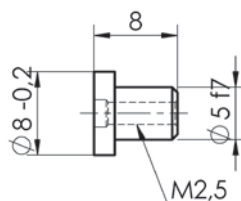

Marked	Order no.	List price EUR
	0741 132	84.00



0741 Pair of adapters for thread measuring inserts (pair)

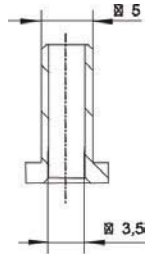

Model

- Adapter for thread measuring inserts with a long shank (length 13.5 mm)

⌘	⌘	Order no.	List price EUR
		0741 134	146.00

0741 Measuring table



Model

- Practical accessories to rebuild the UHRTAST to a fixed measuring device

Delivery

- Cardboard box

⌘	⌘	Size of table mm	Order no.	List price EUR
		Ø 180	0741 184	623.00



0753 Universal indicator stands with magnetic base



0753 110



0753 120

Model

- Chrome finished columns
- Base with V-groove
- Magnet with ON/OFF switch
- Mounting clamp: Ø 8 mm for indicators
- Integrated fine adjustment

Delivery

- Cardboard box

✕	¼	Projection mm	Column height mm	Column dia. mm	Arm dia. mm	Base dimensions mm	Magnetic force N	Order no.	List price EUR
		140	230	16	12	60 x 50 x 55	500	0753 110	23.90
		180	285	16	16	70 x 46 x 65	600	0753 120	59.00



0750 Universal indicator stands with magnetic base and combi clamp



0750 101

Model

- Chrome plated columns
- Base with V-groove
- Magnet with ON/OFF switch
- Combi clamp: Ø 8 mm for dial gauges, swallow tail clamp for dial test indicators
- Intergrated fine adjustment

Delivery

- Cardboard box

Accessories

wooden case for magnet - measuring support

Order no.

0750 601

List price EUR

24.10

»	¼	Projection mm	Column height mm	Column dia. mm	Arm dia. mm	Base dimensions	Magnetic force N	Order no.	List price EUR
Crosshead clamp									
		180	285	16	16	70 x 46 x 65	600	0750 101	134.00
		180	500	20	16	75 x 60 x 102	800	0750 102	179.00

0750 Pillar with transverse arm and fine adjustment



Model

- Chrome plated column and transverse bar
- Mounting for indicator:
 - shank mounting Ø 8 mm for dial gauges
 - swallow tail clamp for dial test indicators
- Integrated fine adjustment

»	¼	Thread	Projection mm	Column height mm	Column dia. mm	Arm dia. mm	Description	Order no.	List price EUR
		M10	180	285	16	16	for 0750 101	0750 121	82.00
		M12	180	500	20	16	for 0750 102	0750 122	92.00

0750 Magnetic base



0750 111

Model

- Magnetic base with V-groove
- Cling to flat and cylindric parts
- Magnetic force can be switched On / Off by rotary switch can

»	¼	Thread	Base dimensions	Magnetic force N	Order no.	List price EUR
		M10	70 x 46 x 65	600	0750 111	57.00
		M12	75 x 60 x 80	800	0750 112	105.00



0751 Magnetic indicator stands with flexible arm



0751 103



0751 104

Model

▪ 0751 103:

- with flexible arm
- holding force by rope tension on hinge segments
- switch magnetic base

▪ 0751 104:

- fixed column
- with fine adjustment
- flexible transverse arm
- switch magnetic base

Delivery

- Cardboard box

⌘	¼	Column height mm	Column dia. mm	Base dimensions mm	Magnetic force N	Order no.	List price EUR
Heavy duty stand							
		350	-	70 x 45 x 65	600	0751 103	113.00
Clamping via the star knob screw							
		350	16	70 x 45 x 65	600	0751 104	132.00

0754 Universal magnetic holder



Model

- Magnetic base with V-groove
- With mounting hole Ø 8 mm
- Three-sided magnet

Delivery

- Cardboard box

⌘	¼	Column height mm	Base dimensions mm	Magnetic force N	Order no.	List price EUR
		57	70 x 35	260	0754 101	95.00



0752 Magnetic indicator stands with central lock



0752 101



0752 103

3

Model

- Column / Arm:
 - 0752 101 steel, chrome finished
 - 0752 103 aluminium, anodized
- Switch magnetic base with V-groove
- Central magnetic clamping system

- **Combi clamp:** Ø 8 mm for dial gauges, swallow tail clamp for dial test indicators
- Intergrated fine adjustment

Delivery

- Cardboard box

☒	☒	Projection mm	Column height mm	Column dia. mm	Base dimensions mm	Magnetic force N	Order no.	List price EUR
		260	310	10	70 x 46 x 65	600	0752 101	138.00
		320	370	18	70 x 46 x 65	600	0752 103	177.00

0756 Universal magnetic holder



Model

- Cast iron base with two magnets on the bottom of the holder
- With mounting hole Ø 8 mm

Delivery

- Cardboard box

☒	☒	Column height mm	Base dimensions mm	Magnetic force N	Order no.	List price EUR
		45	72 x 37	180	0756 101	57.00



0770 Compact measuring stands



0770 102



0770 103



0770 201

Model

- Cast base
- Chrome finished columns
- Hardened steel table
- With dust grooves (Order No. 0770 102 non-stop plane)
- With mounting hole for dial gauges \varnothing 8 mm

Delivery

- Cardboard box

✂	📏	Measuring height mm	Projection mm	Size of table mm	Column dia. mm	Arm dia. mm	Order no.	List price EUR
With fixed arm								
		100	49	\varnothing 50	22	-	0770 102	169.00
		100	49	60 x 68	22	-	0770 103	214.00
With adjustable transverse arm								
		100	100	60 x 68	22	18	0770 201	216.00
		150	135	98 x 115	28	20	0770 205	335.00



0772 Measuring stand



Model

- Cast base
- Hardened steel table
- With dust grooves
- With a threaded column and an adjustable transverse arm
- With mounting hole for dial gauges Ø 8 mm

Delivery

- Cardboard box

☒	☒	Measuring height	Projection	Size of table	Column dia.	Arm dia.	Order no.	List price
		mm	mm	mm	mm	mm		EUR
		160	200	170 x 215	35	22	0772 024	728.00

0785 Precision measuring stands



Model

- Base made of hard stone
- Base plate accuracy according to DIN 876-00
- With a threaded column
- With adjustable transverse arm
- With mounting hole for dial gauges Ø 8 mm
- Vertical adjustment by threaded spindle with setting ring

Delivery

- Cardboard box

☒	☒	Measuring height	Projection	Size of table	Column dia.	Arm dia.	Order no.	List price
		mm	mm	mm	mm	mm		EUR
		200	200	150 x 260	35	22	0785 108	613.00
	▪	220	220	300 x 350	35	22	0785 109	1502.00
		Anti-twist (secured against rotation) transverse arm						
	▪	220	220	300 x 350	35	22	0785 110	1727.00



0763 Universal measuring support



Model

- Column and transverse arm chrome plated
- Column is moving and can be clamped in the T-groove
- Heavy base plate with prismatic base and T-groove
- Mounting for display devices:
 - support for indicators with shaft $\varnothing 8$ mm, swallow tail clamp for dial test indicators
- Integrated fine adjustment

Delivery

- Cardboard box

✕	¼	Projection mm	Column height mm	Column dia. mm	Arm dia. mm	Base dimensions mm	Order no.	List price EUR
		180	300	16	16	250 x 60 x 35	0763 100	268.00



0780 Bench centres

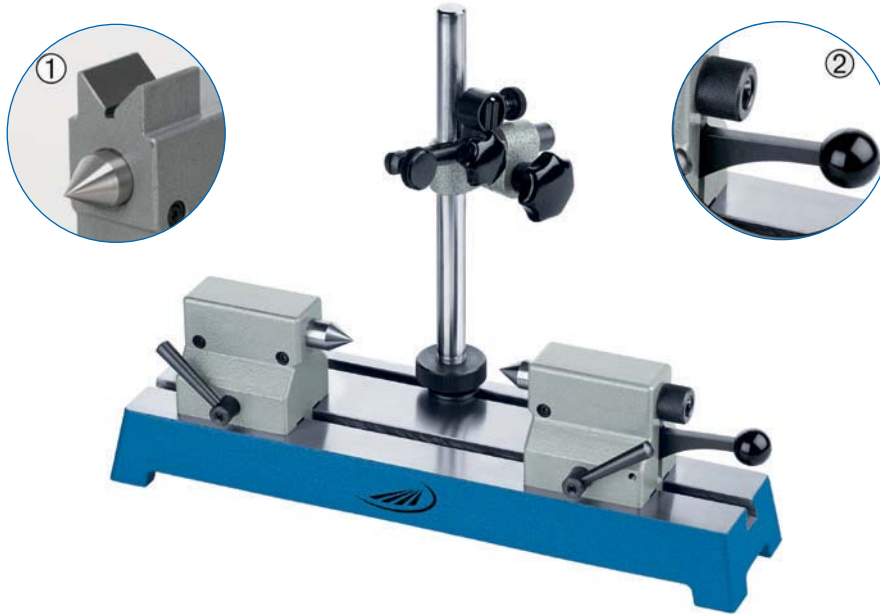

3

Model

- Finely ground surface, flatness tolerance according to DIN 876-2
- With two adjustable tailstocks
- Left tailstock with fixed centre
- Right tailstock with retractable spring mounted centre, free lift appr. 10 mm

Delivery

- Tailstocks can be clamped via an eccentric clamp
- Tailstock height 75 mm with integrated V-groove support
- Quick-clamping device by clamping lever
- With T-groove and support column
- With mounting hole for dial gauges \varnothing 8 mm

»	▣	Height of centers	Workpiece load	Distance between centres	Centre dia.	T-groove width	Base	Order no.	List price
		mm	p. tailstock max. kg	mm	mm	mm	mm		EUR
		50	5	200	16	10	350 x 110	0780 101	581.00
		50	5	350	16	10	500 x 110	0780 102	737.00
		75	5	200	16	10	350 x 110	0780 104*	664.00
		75	5	350	16	10	500 x 110	0780 105*	756.00
	▪	100	20	450	22	12	700 x 180	0780 107	1904.00
	▪	150	20	450	22	12	700 x 180	0780 108	2123.00

* With integrated V-groove support on the tailstocks



0780 Bench centres for heavy workpieces



Model

- Finely ground surface, flatness tolerance according to DIN 876-2
- With two adjustable tailstocks
- Left tailstock with fixed centre
- Right heavy tailstock with moveable, spring mounted centre. free lift appr, 10 mm
- Tighten by hand crank
- Tailstock can be clamped via an eccentric clamp
- Base made of cast iron with T-groove
- Measuring stand with mounting hole for dial gauges Ø 8 mm

Delivery

- Cardboard box

✕	☞	Height of centres	Workpiece load p.	Distance	Centering tip dia.	T-groove width	Base	Order no.	List price
		mm	tailstock max. kg	between centres mm	mm	mm	mm		EUR
	▪	100	40	450	22	12	700 x 180	0780 141	2031.00
	▪	150	40	450	22	12	700 x 180	0780 142	2298.00

0780 Pair of v-support inserts



Model

- V-support inserts to place in and for testing of shafts without centerbores
- V-support inserts are exchanged for the pointed alignment centre of the tailstocks



✕	☞	For height of centres	Contact surface	Order no.	List price
		mm	mm		EUR
		50/75	3 - 15	0780 021	84.00
		100	8 - 45	0780 023	128.00

0780 Replacement support column



Model

- Column is moving and can be clamped in the T-groove
- Mounting for indicator:
 - Shaft mounting Ø 8 mm for dial test indicators
- Integrated fine adjustment



✕	☞	For height of centres	Projection	T-groove width	Column height	Column dia.	Arm dia.	Order no.	List price
		mm	mm	mm	mm	mm	mm		EUR
		50/75	105	10	200	18	14	0780 072	101.00
		100	105	12	240	18	14	0780 073	177.00
		150	105	12	440	18	14	0780 074	203.00



0780 Left tailstocks with a rotating collet chuck



Model

- The left tailstock can be changed because of this specification with a collect chuck
- The collect chuck is rotatable for runout testing
- T grooves bearing
- Eccentric clamp

Height of centers mm	T-groove width mm	Order no.	List price EUR
For collet chucks type F10 (Ø 1 - 7 mm)			
50	10	0780 001	361.00
75	10	0780 002	400.00
For collet chucks type F14 (Ø 1 - 10 mm)			
100	12	0780 003	623.00

- Collet chucks F10 from 1-7 mm are available upon request
- Collet chucks F14 from 1-10 mm are available upon request

Pair of replacement tailstocks for 0780

Model

- 2 tailstocks made of cast iron, with T grooves bearing, with eccentric clamp
- Left tailstock with fixed centre
- Right tailstock with retractable spring mounted centre and clamping lever (quick-clamping device)

Height of centers mm	Workpiece load p. tailstock max. kg	T-groove width mm	Order no.	List price EUR
50	5	10	0780 091	365.00
75	5	10	0780 092	410.00
100	20	12	0780 093	844.00
150	20	12	0780 094	872.00

Pair of V-groove supports for 0780



Model

- For workpieces without centering
- Functional test through applying on e.g. plain lateral surface
- Recognition of form errors
- For exchange of centre supports
- Prismatic contact surface 90°
- V-groove surfaces made of hardened steel (replaceable)
- T grooves bearing
- Eccentric clamp

Height of centers mm	T-groove width	Contact surface mm	Order no.	List price EUR
65	10	5 - 25	0780 032	155.00
100	12	5 - 50	0780 033	222.00

* based on the center of an axis of a shaft Ø 10 mm

Pair of roller supports for 0780



Model

- For exchange of centresupports
- Ball bearing rollers for easy turning of the workpieces

Height of roller supports mm	T-groove width	Contact surface mm	Order no.	List price EUR
65	10	3 - 30	0780 042	185.00
100	12	4 - 60	0780 043	250.00

* based on the center of an axis of a shaft Ø 10 mm



0783 Bench centre



DIN
876-1



Model

- Dark granite work bench
- Flatness tolerance in accordance to DIN 876-1
- Right tailstock with retractable spring mounted centre (quick adjustment lever)
- Left tailstock with fixed centre
- Tailstocks can be adjusted via an eccentric clamp

Delivery

- Wooden handling case
- Included:
 - Work bench
 - Support post
 - 1 pair of tailstocks with pointed alignment centre 60° MK 2

☒	☒	Height of centers mm	Workpiece load p. tailstock max. kg	Distance between centres mm	T-groove width mm	Base mm	Order no.	List price EUR
▪		200	24	650	14	1100 x 180	0783 012	3402.00

Accessories	Order no.	List price EUR
Pair of pointed alignment centres	0782 181	216.00
Tailstock	0782 191	1125.00
Measuring support	0783 070	284.00

0782 Pair of roller supports



Model

- For exchange of centre supports
- Ball bearing rollers for easy turning of the workpieces
- T-grooves bearing
- Eccentric clamp

☒	☒	Height of roller supports mm	T-groove width mm	Contact surface mm	Order no.	List price EUR
		200	14	25 - 100	0782 160	678.00



0784 Concentricity measuring gauge with disc supports

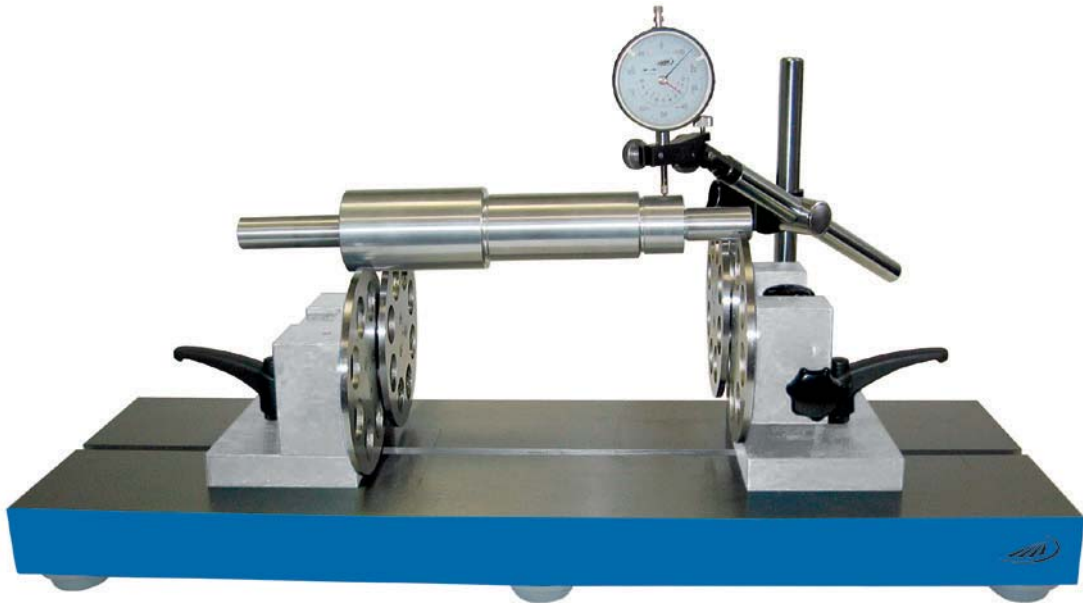

3

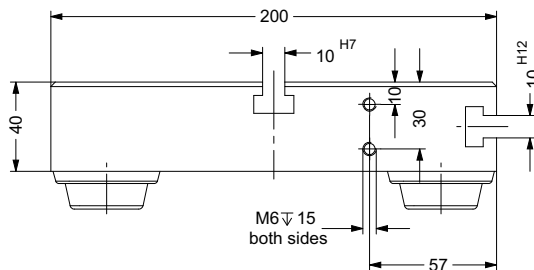

Model

- Centerless concentricity measuring instrument
- High accuracy discs are being mounted on bearings; free of play
- Discs can be slid to either side on the base

Delivery

- One sliding disc can be adjusted up to 30 mm for diametral compensation
- Concentricity accuracy < 5 μm
- wooden case
- includes the support post, excludes a dial gauge

Workpiece load p. tailstock max. kg	Distance between the end mm	Disc diameter mm	Max. workpiece dia. mm	Order no.	List price EUR
25	400	120	250	0784 108	2976.00



0788 Shaft measuring instrument



Model

- For rapid measurement of diameters, distances, shoulders, taper, roundness, etc.
- For vertical and horizontal alignment
- Vertical base with 3 hardened adjustment support surfaces
- Measuring beam is made of hardened steel
- Load capacity horizontal max. 20 kg

Delivery

- Cardboard box
- Without measuring support, guideway, dial gauge (optional accessories)



application as a bench centre

⊗	⊗	Height of centres mm	Distance between centres mm	T-groove width mm	Base mm	Order no.	List price EUR
▪		75	550	10 H7	200 x 120	0788 104	1085.00

Accessories	Order no.	List price EUR
Support arm with guideways	0788 180	220.00



0788 180



0788 Shaft measuring instrument lightweight



Model

- For rapid measurement of distances, shoulders, taper, roundness, etc.
- Vertical and horizontal alignment
- Vertical base with 3 hardened adjustment support surfaces
- Measuring beam is made of hard anodized aluminium profile
- Aluminium tailstocks
- Load capacity horizontal max. 15 kg

Delivery

- Cardboard box
- Without measuring support, guideway, dial gauge (optional accessories)



application as a bench centre

3

✕	¼	Height of centers mm	Distance between the end mm	T-groove width mm	Base mm	Order no.	List price EUR
		75	550	10.1 +0.1	200 x 150	0788 904	864.00

Accessories

	Order no.	List price EUR
Support arm with holder	0788 980	70.00
Support arm with guideways	0788 990	313.00



0788 980



0788 990



SAMPLES MARKING GAUGES

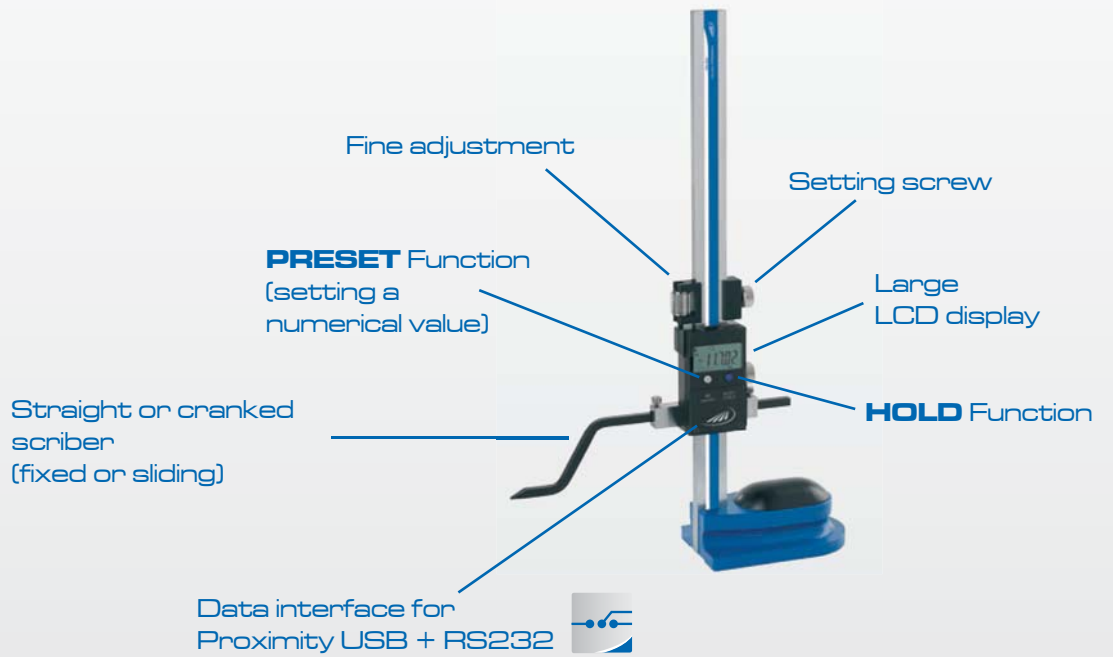

More products from our range of **Marking gauges**



MARKING**GAUGES**



DIVIDERS



MARKING**CALIPERS**

4. CHAPTER MARKING GAUGES

180	Scribers
181	Dividers
183	Beam compass
186	Internal and external calipers
188	Marking calipers / Marking gauges
192	Height and scribing gauges





0300 Scribes



✂	☞	Length mm	Material	Order no.	List price EUR
With straight screw-in scribe					
		175	Chromium-vanadium steel, hardened	0300 007	2.00
		175	Carbide-tipped	0300 103	9.90
With one straight and one L-shaped screw-in scribes					
		250	Chromium-vanadium steel, hardened	0300 008	2.20
With one straight and one angled screw-in and burnished scribes					
		200	Chromium-vanadium steel, hardened	0300 011	2.00
		250	Carbide-tipped	0300 114	8.40
With a mechanic and pocket clip					
		150	Carbide-tipped	0300 120	12.30
One piece hexagonal body with a pocket clip					
		180	Carbide-tipped	0300 102	5.40
With straight scribe. plastic handle. With straight scribe. ball point pen form. incl. 20 interchangeable marking scribes					
		125	Chromium-vanadium steel, hardened	0300 013	9.80
For scribe 0300 008. With straight scribe. plastic handle					
		110	Carbide-tipped	0300 112	4.50

0300 Replacement scribes



✂	☞	Length mm	Material	Order no.	List price EUR
For scribes 0300 007, 0300 008					
		86	Chromium-vanadium steel. hardened	0300 009	1.00
For scribe 0300 008					
		80	Chromium-vanadium steel. hardened	0300 010	1.00
For scribe 0300 013: (Package = 50 pieces)					
		16	Chromium-vanadium steel. hardened	0300 014	3.40
For scribes 0300 120					
		33	Carbide	0300 130	3.30





0301 Precision dividers



Model

- With a rivetted hinge
- Hardened needle shaped-ground points
- Special steel

Delivery

- Cardboard box

✂	☞	Radius mm	Order no.	List price EUR
		150	0301 001	7.00
		175	0301 002	8.00
		200	0301 003	8.80
		250	0301 004	12.30
		300	0301 005	14.90
		400	0301 006	40.20
		500	0301 007	57.00
		600	0301 008	75.00
		800	0301 009	105.00
		1000	0301 010	154.00

0302 / 0306 Dividers with quadrant



Model

- With a rivetted hinge
- Special steel
- Quadrant with robust, milled locking screw
- Hardened points

Delivery

- Cardboard box

✂	☞	Radius mm	Order no.	List price EUR
		150	0302 001	10.30
		175	0302 002	11.30
		200	0302 003	12.10
		250	0302 004	15.80
		300	0302 005	20.70
		400	0302 006	58.00
		500	0302 007	71.00
		600	0302 008	91.00
		800	0302 009	127.00
		1000	0302 010	176.00
With pencil holder				
		150	0306 001	13.10
		200	0306 003	14.90
		300	0306 005	23.20



0310 Spring dividers



Model

- Quick release set screw
- Special steel
- Fixed points
- Hardened points
- Quick release set screw and spring are burnished

Delivery

- Cardboard box

»»	¼	Radius mm	Order no.	List price EUR
		100	0310 101	3.50
		125	0310 102	3.80
		150	0310 103	4.20
		200	0310 105	4.70
		250	0310 107	6.00
		300	0310 108	7.10

0311 Spring dividers



Model

- Quick release set screw
- Special steel
- Interchangeable points
- Hardened points
- Quick release set screw and spring are burnished

Delivery

- Cardboard box

»»	¼	Radius mm	Order no.	List price EUR
		100	0311 101	3.50
		125	0311 102	4.00
		150	0311 103	4.70
		200	0311 105	5.60
		250	0311 107	6.80
		300	0311 108	7.30

0311 Pair of replacement points for spring dividers



»»	¼	Material	Order no.	List price EUR
		Special steel, hardened	0311 120	2.20
		Carbide-tipped	0311 121	18.30



0316 Beam trammel



Model

- With interchangeable steel points
- Stainless steel
- Locking screw
- Fine adjustment
- Factory standard

Delivery

- Cardboard box

Measuring range	Reading	Rail cross-section	Order no.	List price
mm	mm	mm		EUR
500	0.1	25 x 6	0316 201	141.00
1000	0.1	25 x 6	0316 202	195.00

0316 Pair of replacement points, threaded



Model

- Thread M5

Length	Material	Diameter	Order no.	List price
mm		mm		EUR
58	Special steel, hardened	6	0316 110	7.40
58	Carbide	6	0316 111	29.10

0316 Beam trammel with roller



Model

- Flat beam
- Special steel
- Locking screw
- Fine adjustment
- Factory standard

Delivery

- Cardboard box
- From measuring range 2000 mm in transportation box

Measuring range	Reading	Rail cross-section	Order no.	List price
mm	mm	mm		EUR
500	0.1	25 x 6	0316 151	125.00
1000	0.1	25 x 6	0316 152	157.00
▪ 1500	0.1	25 x 6	0316 153	190.00
▪ 2000	0.1	25 x 6	0316 154	244.00



0317 Beam compass with round measuring beam



Model

- Beam is made of special steel
- Guide groove
- Slide bars are made of aluminium
- mm graduation
- Locking screws
- Interchangeable hardened scribers
- Factory standard

Delivery

- Cardboard box
- From measuring range 2000 mm in transportation box

☒	☒	Measuring range mm	Rail diameter mm	Reading mm	Order no.	List price EUR
Without fine adjustment						
		0 - 500	20	0.1	0317 001	65.00
		0 - 1000	20	0.1	0317 002	92.00
	▪	0 - 1500	20	0.1	0317 003	119.00
	▪	0 - 2000	20	0.1	0317 004	163.00
	▪	0 - 3000	28	0.1	0317 005	375.00
	▪	0 - 4000	28	0.1	0317 006	610.00
	▪	0 - 5000	28	0.1	0317 007	814.00
With fine adjustment						
		0 - 500	20	0.1	0317 101	78.00
		0 - 1000	20	0.1	0317 102	105.00
	▪	0 - 1500	20	0.1	0317 103	136.00
	▪	0 - 2000	20	0.1	0317 104	177.00
	▪	0 - 3000	28	0.1	0317 105	391.00
	▪	0 - 4000	28	0.1	0317 106	615.00
	▪	0 - 5000	28	0.1	0317 107	810.00

0317 Pair of replacement points (clamp)



☒	☒	Material	Diameter mm	Order no.	List price EUR
		Special steel, hardened	6	0317 010	8.10
		Carbide-tipped	6	0317 110	23.00



0314 Marking calipers



Model

- Special steel
- Locking screw
- Laser graduated
- Factory standard

Delivery

- Cardboard box

⊞	⊞	Measuring range mm	Radius mm	Reading mm	Jaw length mm	Order no.	List price EUR
Hardened scribing tips							
		0 - 150	300	0.1	40	0314 002	74.00
		0 - 200	400	0.1	40	0314 003	84.00
		0 - 250	500	0.1	40	0314 004	88.00
		0 - 300	600	0.1	40	0314 005	94.00
Carbide scribing tips							
		0 - 150	300	0.1	40	0314 102	112.00
		0 - 200	400	0.1	40	0314 103	133.00
		0 - 250	500	0.1	40	0314 104	137.00
		0 - 300	600	0.1	40	0314 105	142.00

0308 Combined internal / external calipers



Model

- Internal and external caliper
- Stainless steel
- Satin chrome finished scale
- With a rivetted hinge
- mm graduation for internal and external measurement

Delivery

- Cardboard box

⊞	⊞	Length mm	Measuring range mm	Order no.	List price EUR
		190	0 - 120	0308 201	90.00
		250	0 - 160	0308 202	108.00
		310	0 - 200	0308 303	132.00
		460	0 - 300	0308 305	156.00



0303 Precision internal calipers



Model

- With a rivetted hinge
- Special steel
- Hardened measuring points

Delivery

- Cardboard box
- From measuring range 2000 mm in a transportation box

▶▶	⊗	Length mm	Order no.	List price EUR
		150	0303 001	6.80
		175	0303 002	7.40
		200	0303 003	8.40
		250	0303 004	9.00
		300	0303 005	10.30
		400	0303 006	12.60
		500	0303 007	15.60
		600	0303 008	23.60
		800	0303 009	34.00
		1000	0303 010	62.00
	▪	1200	0303 012	545.00
	▪	1500	0303 015	579.00
	▪	2000	0303 020	617.00

0304 Precision external calipers



Model

- With a rivetted hinge
- Special steel
- Hardened measuring points

Delivery

- Cardboard box
- From measuring range 2000 mm in a transportation box

▶▶	⊗	Length mm	Order no.	List price EUR
		150	0304 001	6.80
		175	0304 002	7.40
		200	0304 003	8.40
		250	0304 004	9.00
		300	0304 005	10.30
		400	0304 006	12.60
		500	0304 007	15.60
		600	0304 008	23.60
		800	0304 009	34.00
		1000	0304 010	62.00
	▪	1200	0304 012	545.00
	▪	1500	0304 015	579.00
	▪	2000	0304 020	617.00



0312 Spring internal calipers



Model

- Internal caliper with quick release set screw
- Special steel
- Quick release set screw and spring are burnished

Delivery

- Cardboard box

⌘	¼	Length mm	Order no.	List price EUR
		100	0312 101	3.30
		150	0312 103	4.70
		200	0312 105	5.70
		250	0312 107	7.00
		300	0312 108	8.40

0313 Spring external calipers



Model

- External caliper with quick release set screw
- Special steel
- Quick release set screw and spring are burnished

Delivery

- Cardboard box

⌘	¼	Length mm	Order no.	List price EUR
		100	0313 101	3.30
		150	0313 103	4.70
		200	0313 105	5.70
		250	0313 107	7.00
		300	0313 108	8.40



0343 Marking calipers

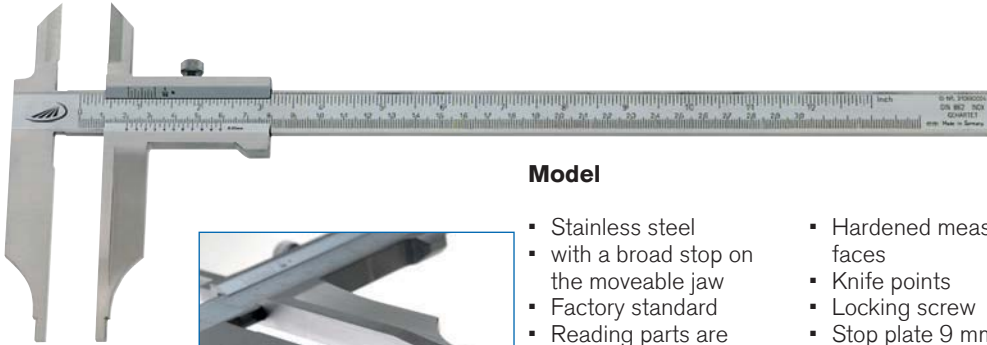

Model

- Stainless steel
- with a broad stop on the moveable jaw
- Factory standard
- Reading parts are satin chrome finished
- Hardened measuring faces
- Knife points
- Locking screw
- Stop plate 9 mm

Delivery

- Cardboard box

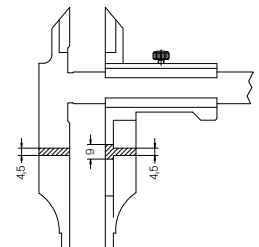

✂	📏	Measuring range	Reading	Rail cross-section	Jaw length	Jaws for inside measurements	Order no.	List price
		mm	mm	mm	mm	mm		EUR
		0 - 250	0.05	20 x 5	90	10	0343 501	255.00
		0 - 300	0.05	20 x 5	90	10	0343 503	287.00

0344 Marking calipers

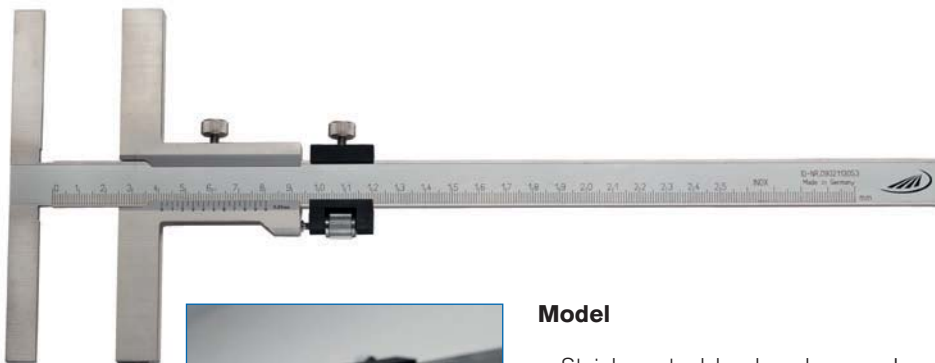

Model

- Stainless steel, hardened
- Long T-shaped marking edge
- Factory standard
- Reading parts are satin chrome finished
- Low set master scale
- Fine adjustment
- Locking screw

Delivery

- Cardboard box

✂	📏	Measuring range	Reading	Rail cross-section	Length of beam	Order no.	List price
		mm	mm	mm	mm		EUR
		0 - 160	0.05	20 x 5	135	0344 501	125.00
		0 - 250	0.05	20 x 5	135	0344 502	159.00
		0 - 300	0.05	20 x 5	160	0344 503	202.00
		0 - 500	0.05	25 x 6	160	0344 505	428.00



0321 Marking gauges

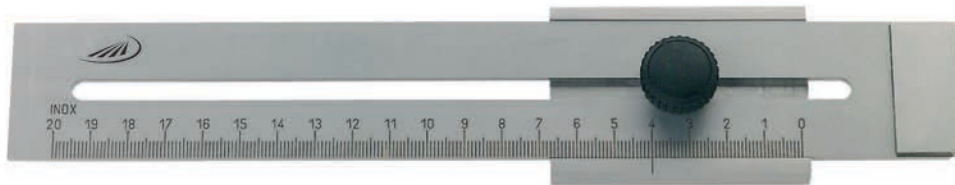

Model

- Flat, stable construction
- Stainless steel, chrome finished
- Locking screw
- Hardened stop face
- mm graduated scale
- Factory standard

Delivery

- Cardboard box

⌘	⌘	Measuring range mm	Reading mm	Rail cross-section mm	Order no.	List price EUR
		0 - 200	1	40	0321 301	21.80
		0 - 250	1	40	0321 302	24.40
		0 - 300	1	40	0321 303	24.90
		0 - 500	1	40	0321 305	47.30

0323 Marking gauges



4



0323 308

Model

- Stainless steel
- Locking screw
- For marking by scale as well as for marking of 45° - or 90° - mitres
- mm graduation
- Factory standard

Delivery

- Cardboard box

⌘	⌘	Measuring range mm	Reading mm	Rail cross-section mm	Order no.	List price EUR
		100	1	40	0323 308	16.20
		200	1	40	0323 318	20.70



0318 Marking calipers

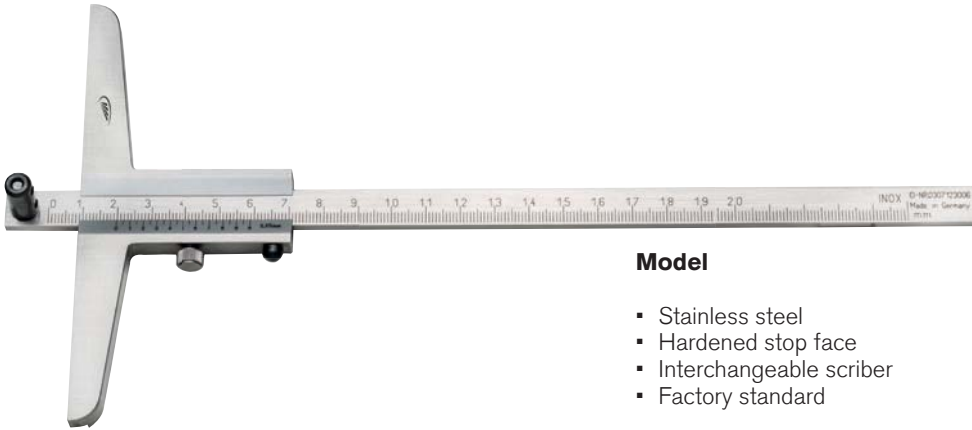

Model

- Stainless steel
- Hardened stop face
- Interchangeable scriber
- Factory standard

Delivery

- Cardboard box

Marked	Measuring range mm	Reading mm	Rail cross-section mm	Length of beam mm	Order no.	List price EUR
	0 - 200	0.05	12 x 4	130	0318 201	148.00
	0 - 300	0.05	12 x 4	130	0318 203	157.00

0318 Replacement scribers



Marked	Material	Order no.	List price EUR
	Special steel, hardened	0318 210	12.50
	Carbide-tipped	0318 211	40.50

0322 Marking gauges with guide roll

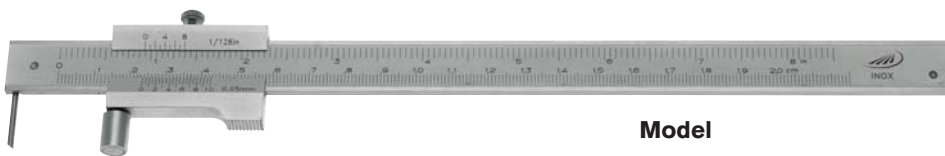

Model

- Stainless steel, hardened
- Reading parts are satin chrome finished
- Guide roll
- Locking screw
- Interchangeable scriber made of hardened steel
- Factory standard

Delivery

- Cardboard box

Marked	Measuring range mm	Reading mm	Order no.	List price EUR
	0 - 200	0.05	0322 501	24.90
	0 - 400	0.05	0322 503	39.00

Accessories	Order no.	List price EUR
Replacement scribers	0322 510	4.40



0319 Marking gauges with a round measuring beam



Model

- With guide groove
- Stainless steel beam
- Slide bars are made of steel, rectangular stop plate
- Scriber interchangeable, made of hardened steel
- mm graduation
- Factory standard

Delivery

- Cardboard box

»	¼	Measuring range mm	Rail diameter mm	Reading mm	Order no.	List price EUR
Without fine adjustment						
		0 - 200	12	0.1	0319 001	35.30
		0 - 300	12	0.1	0319 002	44.20
		0 - 400	12	0.1	0319 003	63.00
		0 - 500	12	0.1	0319 004	85.00
With fine adjustment						
		0 - 200	12	0.1	0319 101	45.20
		0 - 300	12	0.1	0319 102	53.00
		0 - 400	12	0.1	0319 103	73.00
		0 - 500	12	0.1	0319 104	92.00

0320 Marking gauges with a round measuring beam

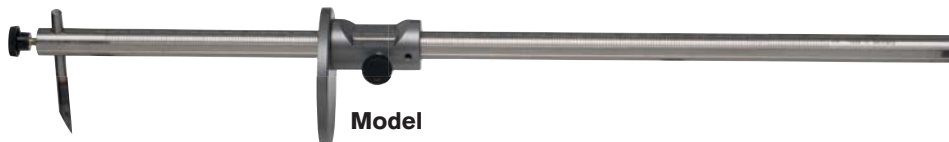

Model

- With guide groove
- Stainless steel beam
- Slide bars are made of steel, rectangular stop plate
- Scriber interchangeable, made of hardened steel
- mm graduation

Delivery

- Cardboard box

»	¼	Measuring range mm	Rail diameter mm	Reading mm	Order no.	List price EUR
		0 - 300	12	0.1	0320 001	44.20
		0 - 500	12	0.1	0320 002	85.00
Hardened stop plate						
		0 - 300	12	0.1	0320 101	69.00
		0 - 500	12	0.1	0320 102	108.00

0319 Replacement scribers



»	¼	Material	Order no.	List price EUR
		Special steel, hardened	0319 010	3.70
		Carbide	0319 510	38.40



0345 / 0347 Analogue height and scribing gauges



0345 522

0347 522

Model

- Measuring beam is made from stainless steel
- Vernier and scale are satin chrome finished
- Parallax-free reading
- Setting screw
- Fine adjustment
- Accurate fine adjustment on gear rack and setting wheel with pinion
- Steel base with dirt grooves
- Scribing possible from base plate level
- Factory standard

Delivery

- With exchangeable scriber, carbide tipped



② Fine adjustment on gear rack

✕	⊗	Measuring range mm	Reading mm	Base dimensions mm	Rail cross-section mm	Order no.	List price EUR
With fine adjustment							
		0 - 300	0.02	145 x 90 x 44	30 x 12	0345 522	373.00
		0 - 600	0.02	189 x 118 x 44	30 x 12	0345 530	467.00
		0 - 1000	0.02	189 x 118 x 44	30 x 12	0345 534	643.00
With pinion							
		0 - 300	0.02	145 x 90 x 44	30 x 12	0347 522	477.00
		0 - 600	0.02	189 x 118 x 44	30 x 12	0347 530	602.00
		0 - 1000	0.02	189 x 118 x 44	30 x 12	0347 534	830.00

0345 Replacement scribers for 0345 / 0347



Model

- Carbide tipped
- Packing: individually packed

✕	⊗	Length mm	Material	Order no.	List price EUR
		75	Carbide-tipped	0345 910	119.00
		150	Carbide-tipped	0345 912	132.00



0345 / 0347 DIGI-MET® Height and scribing gauges



Model

- Measuring beam is made from stainless steel
- LCD-display 11 mm
- Setting screw
- Fine adjustment
- Accurate fine adjustment on gear rack and setting wheel with pinion
- Steel base with dirt grooves
- Scribing possible from base plate level
- Factory standard

Functions



- ON / OFF
- Set to zero at any point
- mm / inch switching
- PRESET-Function (setting a numerical value)
- Hold
- ABS (display can be set to zero without losing the Preset value)
- Reversal of counting direction
- Factor input
- Data output Proximity USB + RS232

Delivery

- With interchangeable scribing jaws, carbide tipped



② Fine adjustment on gear rack

⌕	⌕	Measuring range mm	Reading mm	Base dimensions mm	Rail cross-section mm	Order no.	List price EUR
With fine adjustment							
		300	0.01	145 x 90 x 44	30 x 12	0345 722	539.00
		600	0.01	189 x 118 x 44	30 x 12	0345 730	674.00
		1000	0.01	189 x 118 x 44	30 x 12	0345 734	934.00
With pinion							
		300	0.01	145 x 90 x 44	30 x 12	0347 722	664.00
		600	0.01	189 x 118 x 44	30 x 12	0347 730	830.00
		1000	0.01	189 x 118 x 44	30 x 12	0347 734	1142.00

Accessories

Accessories	Order no.	List price EUR
Battery, 3V-Lithium, CR 2032	0220 704	3.70
Data cable Proximity to USB	1998 760	141.00

0345 Replacement scribers for 0345 / 0347



Model

- Carbide tipped
- Packing: individually packed

⌕	⌕	Length mm	Material	Order no.	List price EUR
		75	Carbide-tipped	0345 910	119.00
		150	Carbide-tipped	0345 912	132.00



0349 DIGI-MET® Height gauges with sliding scriber



0349 722*

Model

- Measuring beam is made from special steel
- LCD-display 11 mm
- Fine adjustment
- Setting screw
- Steel base with dirt grooves
- Scribing possible from base plate level

Functions

- ON / OFF
- Set to zero at any point
- mm / inch switching
- PRESET-Function (setting a numerical value)
- Hold
- ABS (display can be set to zero without losing the Preset value)
- Reversal of counting direction
- Factor input
- Data output Proximity USB + RS232

Delivery

- With interchangeable scribing jaws, carbide tipped

Measuring range mm	Reading mm	Base dimensions mm	Rail cross-section mm	Order no.	List price EUR
0 - 300	0.01	145 x 90 x 44	30 x 12	0349 722	570.00
0 - 600	0.01	189 x 118 x 44	30 x 12	0349 730	726.00
0 - 1000	0.01	189 x 118 x 44	30 x 12	0349 734	986.00

Accessories

Accessories	Order no.	List price EUR
Battery, 3V-Lithium, CR 2032	0220 704	3.70
Data cable Proximity to USB	1998 760	141.00

*Figure does not show standard delivery content

0349 Replacement scribers for 0349



Length mm	Material	Order no.	List price EUR
Cranked scriber, for marking operations from base			
270	Hardened steel	0349 912	128.00
270	Carbide tipped	0349 916	162.00
Straight scriber			
270	Hardened steel	0349 910	109.00
270	Carbide tipped	0349 914	142.00



0331 Replacement scriber for height gauges not any longer included in our catalogue



Order no. Scriber	Order no. Height-gauge	0330...	0331...	0336...	0338...	0340...	0342...	Material	Length mm	Shaft mm	List price EUR
0331 011			●		●			straight, hardened steel	270	8 x 8	109.00
0331 030			●					cranked, hardened steel	270	8 x 8	128.00
0331 111			●		●			straight, carbide tipped	270	8 x 8	142.00
0331 130			●					cranked, carbide tipped	270	8 x 8	162.00
0334 101		●		●		●	●	straight, carbide tipped	65	8 x 8	72.00
0334 102		●		●		●	●	straight, carbide tipped	75	-	119.00
0334 105				●				straight, carbide tipped	120	-	87.00
0334 106				●				straight, carbide tipped	150	-	132.00
0338 354					●			cranked, hardened steel	270	8 x 8	140.00
0338 357					●			cranked, carbide tipped	270	8 x 8	182.00



SAMPLES **SQUARES**

SQUARE **WITH BASE**

SQUARE **WITHOUT BASE**



HIGH **QUALITY**

MADE IN **GERMANY**

Manufactured according to **DIN 875**

Highest precision:
Accuracy **grade 0**

Blade length up to **2 meters**
(Accuracy grade 2)

Made from **special** or **stainless** steel

More **highlights** from our range of **squares**



ACUTE ANGLE
SQUARES



MITRE SQUARES



BEVEL
PROTRACTORS

5. CHAPTER SQUARES, PROTRACTORS AND BEVEL PROTRACTORS

198	Squares with / without base
202	Steel squares
203	Squares with hard and slim blade
205	Knife edge squares
206	Inspection set
207	Centre squares / Flange squares
208	Mitre / Acute angle squares
210	Squares for specific measuring tasks and target groups
212	Wooden cases
213	Protractors
216	Universal bevel protractors





0368 Squares with base accuracy grade 0



Model

- DIN 875
- Accuracy grade 0
- For exact angle testing (for example: tool making)

Delivery

- Cardboard box
- From blade length 1000 mm in a transportation box

✂	☞	Length of beams mm	Cross-section mm	Order no.	List price EUR
Special steel					
		75 x 50	15 x 5	0368 102	15.40
		100 x 70	20 x 5	0368 103	17.90
		150 x 100	25 x 5	0368 104	27.10
		200 x 130	30 x 6	0368 105	34.70
		250 x 165	35 x 7	0368 106	50.00
		300 x 200	40 x 8	0368 107	68.00
		400 x 265	45 x 10	0368 108	148.00
		500 x 330	50 x 10	0368 109	216.00
		600 x 400	50 x 10	0368 110	309.00
		750 x 500	60 x 12	0368 111	528.00
	▪	1000 x 660	70 x 15	0368 112	947.00
Stainless steel					
		75 x 50	15 x 5	0368 202	23.00
		100 x 70	20 x 5	0368 203	24.80
		150 x 100	25 x 5	0368 204	42.60
		200 x 130	30 x 6	0368 205	61.00
		250 x 165	35 x 7	0368 206	89.00
		300 x 200	40 x 8	0368 207	100.00
		400 x 265	45 x 10	0368 208	187.00
		500 x 330	50 x 10	0368 209	259.00
		600 x 400	50 x 10	0368 210	385.00
		750 x 500	60 x 12	0368 211	661.00
	▪	1000 x 660	70 x 15	0368 212	1403.00

**DIN
875**

0369 Squares without base accuracy grade 0



Model

- DIN 875
- Accuracy grade 0
- For exact angle testing (for example: tool making)

Delivery

- Cardboard box
- From blade length 1000 mm in a transportation box

✂	☞	Length of beams mm	Cross-section mm	Order no.	List price EUR
Special steel					
		75 x 50	15 x 5	0369 102	10.10
		100 x 70	20 x 5	0369 103	11.30
		150 x 100	25 x 5	0369 104	13.90
		200 x 130	30 x 6	0369 105	23.00
		250 x 165	35 x 7	0369 106	31.80
		300 x 200	40 x 8	0369 107	40.80
		400 x 265	45 x 10	0369 108	100.00
		500 x 330	50 x 10	0369 109	123.00
		600 x 400	50 x 10	0369 110	243.00
		750 x 500	60 x 12	0369 111	451.00
	▪	1000 x 660	70 x 15	0369 112	804.00
Stainless steel					
		75 x 50	15 x 5	0369 202	16.70
		100 x 70	20 x 5	0369 203	18.30
		150 x 100	25 x 5	0369 204	24.30
		200 x 130	30 x 6	0369 205	36.80
		250 x 165	35 x 7	0369 206	48.90
		300 x 200	40 x 8	0369 207	68.00
		400 x 265	45 x 10	0369 208	130.00
		500 x 330	50 x 10	0369 209	180.00
		600 x 400	50 x 10	0369 210	302.00
		750 x 500	60 x 12	0369 211	564.00
	▪	1000 x 660	70 x 15	0369 212	1059.00

**DIN
875**



0385 Inspection squares with base accuracy grade 0, hardened



Model

- DIN 875
- Accuracy grade 0
- For exact angle testing (for example: tool making)

Delivery

- Cardboard box

**DIN
875**

»	¼	Length of beams mm	Cross-section mm	Order no.	List price EUR
Special steel					
		50 x 40	15 x 4	0385 102	24.30
		75 x 50	15 x 4	0385 103	25.90
		100 x 70	20 x 5	0385 104	31.00
		150 x 100	25 x 6	0385 105	46.30
		200 x 130	30 x 7	0385 106	64.00
		300 x 200	40 x 8	0385 108	112.00
Stainless steel					
		50 x 40	15 x 4	0385 202	33.70
		75 x 50	15 x 4	0385 203	37.40
		100 x 70	20 x 5	0385 204	46.30
		150 x 100	25 x 6	0385 205	61.00
		200 x 130	30 x 7	0385 206	79.00
		300 x 200	40 x 8	0385 208	116.00

0386 Inspection squares without base accuracy grade 0, hardened



Model

- DIN 875
- Accuracy grade 0
- For exact angle testing (for example: tool making)

Delivery

- Cardboard box

**DIN
875**

5

»	¼	Length of beams mm	Cross-section mm	Order no.	List price EUR
Special steel					
		50 x 40	15 x 4	0386 102	18.30
		75 x 50	15 x 4	0386 103	19.70
		100 x 70	20 x 5	0386 104	24.10
		150 x 100	25 x 6	0386 105	29.80
		200 x 130	30 x 7	0386 106	38.50
		300 x 200	40 x 8	0386 108	74.00
Stainless steel					
		50 x 40	15 x 4	0386 202	23.20
		75 x 50	15 x 4	0386 203	26.30
		100 x 70	20 x 5	0386 204	31.00
		150 x 100	25 x 6	0386 205	40.20
		200 x 130	30 x 7	0386 206	52.00
		300 x 200	40 x 8	0386 208	103.00



0370 Squares with base accuracy grade 1



Model

- DIN 875
- Accuracy grade 1
- For angle testing in production and factory

Delivery

- Cardboard box
- From blade length 1000 mm in a transportation box

☒	☒	Length of beams mm	Cross-section mm	Order no.	List price EUR
Special steel					
		75 x 50	15 x 5	0370 102	9.80
		100 x 70	20 x 5	0370 103	10.90
		150 x 100	25 x 5	0370 104	11.10
		200 x 130	30 x 6	0370 105	18.10
		250 x 165	35 x 7	0370 106	24.10
		300 x 200	40 x 8	0370 107	29.40
		400 x 265	45 x 10	0370 108	80.00
		500 x 330	50 x 10	0370 109	117.00
		600 x 400	50 x 10	0370 110	164.00
		750 x 500	60 x 12	0370 111	367.00
	▪	1000 x 660	70 x 15	0370 112	621.00
Stainless steel					
		75 x 50	15 x 5	0370 202	13.50
		100 x 70	20 x 5	0370 203	16.40
		150 x 100	25 x 5	0370 204	22.40
		200 x 130	30 x 6	0370 205	29.80
		250 x 165	35 x 7	0370 206	44.80
		300 x 200	40 x 8	0370 207	54.00
		400 x 265	45 x 10	0370 208	161.00
		500 x 330	50 x 10	0370 209	198.00
		600 x 400	50 x 10	0370 210	336.00
		750 x 500	60 x 12	0370 211	520.00
	▪	1000 x 660	70 x 15	0370 212	841.00

**DIN
875**

0371 Squares without base accuracy grade 1



Model

- DIN 875
- Accuracy grade 1
- For angle testing in production and factory

Delivery

- Cardboard box
- From blade length 1000 mm in a transportation box

☒	☒	Length of beams mm	Cross-section mm	Order no.	List price EUR
Special steel					
		75 x 50	15 x 5	0371 102	7.40
		100 x 70	20 x 5	0371 103	7.80
		150 x 100	25 x 5	0371 104	9.40
		200 x 130	30 x 6	0371 105	12.80
		250 x 165	35 x 7	0371 106	19.40
		300 x 200	40 x 8	0371 107	23.00
		400 x 265	45 x 10	0371 108	58.00
		500 x 330	50 x 10	0371 109	82.00
		600 x 400	50 x 10	0371 110	113.00
		750 x 500	60 x 12	0371 111	250.00
	▪	1000 x 660	70 x 15	0371 112	429.00
Stainless steel					
		75 x 50	15 x 5	0371 202	9.00
		100 x 70	20 x 5	0371 203	10.90
		150 x 100	25 x 5	0371 204	15.40
		200 x 130	30 x 6	0371 205	21.30
		250 x 165	35 x 7	0371 206	31.00
		300 x 200	40 x 8	0371 207	37.80
		400 x 265	45 x 10	0371 208	125.00
		500 x 330	50 x 10	0371 209	156.00
		600 x 400	50 x 10	0371 210	258.00
		750 x 500	60 x 12	0371 211	473.00
	▪	1000 x 660	70 x 15	0371 212	763.00

**DIN
875**



0372 Squares with base accuracy grade 2



Model

- Special steel
- DIN 875
- Accuracy grade 2
- For angle testing in production and factory

Delivery

- Cardboard box
- From blade length 1500 mm in a transportation box

**DIN
875**

✂	☞	Length of beams mm	Cross-section mm	Order no.	List price EUR
		75 x 50	15 x 5	0372 102	7.60
		100 x 70	20 x 5	0372 103	8.50
		150 x 100	25 x 5	0372 104	11.10
		200 x 130	30 x 6	0372 105	14.20
		250 x 165	35 x 7	0372 106	19.30
		300 x 175	35 x 7	0372 107	24.30
		400 x 200	35 x 7	0372 108	40.80
		500 x 250	40 x 8	0372 109	54.00
		600 x 300	40 x 8	0372 110	73.00
		750 x 375	45 x 10	0372 111	92.00
		1000 x 500	50 x 10	0372 112	127.00
	▪	1500 x 750	60 x 12	0372 113	455.00
	▪	2000 x 1000	60 x 12	0372 114	732.00

0373 Squares without base accuracy grade 2



Model

- Special steel
- DIN 875
- Accuracy grade 2
- For angle testing in production and factory

Delivery

- Cardboard box
- From blade length 1500 mm in a transportation box

**DIN
875**

5

✂	☞	Length of beams mm	Cross-section mm	Order no.	List price EUR
		75 x 50	15 x 5	0373 102	5.40
		100 x 70	20 x 5	0373 103	6.20
		150 x 100	25 x 5	0373 104	8.50
		200 x 130	30 x 6	0373 105	10.30
		250 x 165	35 x 7	0373 106	14.20
		300 x 175	35 x 7	0373 107	18.20
		400 x 200	35 x 7	0373 108	27.40
		500 x 250	40 x 8	0373 109	40.10
		600 x 300	40 x 8	0373 110	54.00
		750 x 375	45 x 10	0373 111	72.00
		1000 x 500	50 x 10	0373 112	105.00
	▪	1500 x 750	60 x 12	0373 113	349.00
	▪	2000 x 1000	60 x 12	0373 114	644.00



0374 Steel squares with base



Model

- Special steel, zinc coated
- Factory standard
- Simple design for angle test in steel and metal construction

Delivery

- Cardboard box
- From blade length 1500 mm in a transportation box

✂	☞	Length of beams mm	Cross-section mm	Order no.	List price EUR
		100 x 70	20 x 5	0374 404	6.30
		150 x 100	20 x 5	0374 408	7.10
		200 x 130	20 x 5	0374 410	8.60
		250 x 160	25 x 5	0374 412	10.50
		300 x 180	25 x 5	0374 414	12.70
		400 x 230	30 x 5	0374 416	16.00
		500 x 280	30 x 5	0374 418	21.40
		600 x 330	30 x 5	0374 420	28.80
		750 x 375	30 x 5	0374 424	34.20
		1000 x 500	30 x 5	0374 428	52.00
	▪	1500 x 750	40 x 5	0374 430	181.00
	▪	2000 x 1000	40 x 5	0374 432	267.00

*polished

0375 Steel squares without base



Model

- Special steel, zinc coated
- Factory standard
- Simple design for angle test in steel and metal construction

Delivery

- Cardboard box
- From blade length 1500 mm in a transportation box

✂	☞	Length of beams mm	Cross-section mm	Order no.	List price EUR
		100 x 70	20 x 5	0375 404	5.10
		150 x 100	20 x 5	0375 408	5.30
		200 x 130	20 x 5	0375 410	5.70
		250 x 160	25 x 5	0375 412	6.90
		300 x 180	25 x 5	0375 414	7.60
		400 x 230	30 x 5	0375 416	10.40
		500 x 280	30 x 5	0375 418	11.50
		600 x 330	30 x 5	0375 420	14.10
		750 x 375	30 x 5	0375 424	16.80
		1000 x 500	30 x 5	0375 428	21.70
	▪	1500 x 750	40 x 5	0375 430	85.00
	▪	2000 x 1000	40 x 5	0375 432	128.00

*polished



0376 Squares with hard and slim blade, accuracy grade 1



Model

Delivery

**DIN
875**

- Special steel
- DIN 875
- Accuracy grade 1
- For angle testing in production and factory

- Cardboard box



✕	☞	Length of beams mm	Cross section with wide beam mm	Cross section with narrow beam mm	Order no.	List price EUR
		75 x 50	14 x 10	14 x 3	0376 102	11.80
		100 x 70	16 x 10	16 x 3	0376 103	12.60
		150 x 100	20 x 12	22 x 3	0376 104	15.80
		200 x 130	24 x 14	24 x 3	0376 105	26.00

0376 Squares with hard and slim blade, accuracy grade 2



Model

Delivery

**DIN
875**

- Special steel
- DIN 875
- Accuracy grade 2
- For angle testing in production and factory

- Cardboard box



✕	☞	Length of beams mm	Cross section with wide beam mm	Cross section with narrow beam mm	Order no.	List price EUR
		75 x 50	14 x 10	14 x 2	0376 112	11.00
		100 x 70	16 x 10	18 x 2	0376 113	11.70
		150 x 100	20 x 12	22 x 3	0376 114	14.20
		200 x 130	24 x 14	24 x 3	0376 115	19.90
		250 x 160	28 x 16	28 x 3	0376 116	24.60
		300 x 175	32 x 18	30 x 3	0376 117	29.30



0390 Squares with hard and slim blade, hardened, accuracy grade 0



Model

- DIN 875
- Accuracy grade 0
- For exact angle testing (for example: tool making)

Delivery

- Cardboard box

DIN
875



▶	🏠	Length of beams mm	Cross section with wide beam mm	Cross section with narrow beam mm	Order no.	List price EUR
Special steel						
		50 x 40	14 x 10	16 x 2	0390 102	34.70
		75 x 50	14 x 10	18 x 2	0390 103	34.70
		100 x 70	16 x 10	18 x 2	0390 104	40.20
		150 x 100	20 x 12	22 x 3	0390 105	51.00
		200 x 130	24 x 14	26 x 3	0390 106	69.00
		300 x 200	30 x 18	32 x 3	0390 108	116.00
Stainless steel						
		50 x 40	14 x 10	16 x 2	0390 202	46.00
		75 x 50	14 x 10	18 x 2	0390 203	52.00
		100 x 70	16 x 10	18 x 2	0390 204	66.00
		150 x 100	20 x 12	22 x 3	0390 205	85.00
		200 x 130	24 x 14	26 x 3	0390 206	107.00
		300 x 200	30 x 18	32 x 3	0390 208	164.00

0391 Knife edge squares with hard and slim blade, hardened, accuracy grade 00



Model

- With knife edge
- DIN 875
- Accuracy grade 00
- For exact flatness testing (for example: in production)

Delivery

- Cardboard box

DIN
875



▶	🏠	Length of beams mm	Cross section with wide beam mm	Cross section with narrow beam mm	Order no.	List price EUR
Special steel, non-glare knife edge						
		50 x 40	14 x 10	16 x 2	0391 102	54.00
		75 x 50	14 x 10	18 x 2	0391 103	54.00
		100 x 70	16 x 10	18 x 2	0391 104	70.00
		150 x 100	20 x 12	22 x 3	0391 105	88.00
		200 x 130	24 x 14	26 x 3	0391 106	119.00
		300 x 200	30 x 18	32 x 3	0391 108	174.00
Stainless steel						
		50 x 40	14 x 10	16 x 2	0391 202	64.00
		75 x 50	14 x 10	18 x 2	0391 203	72.00
		100 x 70	16 x 10	18 x 2	0391 204	82.00
		150 x 100	20 x 12	22 x 3	0391 205	105.00
		200 x 130	24 x 14	26 x 3	0391 206	134.00
		300 x 200	30 x 18	32 x 3	0391 208	218.00



0388 Knife edge squares, hardened, accuracy grade 00



Model

- DIN 875
- Accuracy grade 00
- For exact angle and flatness testing (for example: tool making)

Delivery

- Cardboard box

**DIN
875**

»	¼	Length of beams mm	Cross-section mm	Order no. mm	List price EUR
Special steel, non-glare knife edge					
		50 x 40	14 x 4	0388 102	19.40
		75 x 50	15 x 4	0388 103	23.00
		100 x 70	20 x 5	0388 104	27.50
		150 x 100	25 x 6	0388 105	37.00
		200 x 130	30 x 7	0388 106	52.00
		300 x 200	40 x 8	0388 108	90.00
Stainless steel					
		50 x 40	14 x 4	0388 202	23.00
		75 x 50	15 x 4	0388 203	27.10
		100 x 70	20 x 5	0388 204	32.60
		150 x 100	25 x 6	0388 205	42.10
		200 x 130	30 x 7	0388 206	62.00
		300 x 200	40 x 8	0388 208	136.00
		500 x 330	40 x 10	0388 210	649.00

0394 Knife edge squares



Model

- **0394101**
- Reading parts are satin chrome finished
- Sliding knife 7 x 7 x 60 mm
- Angle $\pm 5^\circ$
- Handle 40 x 23 x 9 mm
- For testing on short edges and grooves through the sliding knife edge

Delivery

- **0394110**
- Wooden case
- Reading parts are satin chrome finished
- Sliding knife edge 7 x 7 x 60 mm
- Handle 40 x 23 x 9 mm
- For tests at short grooves through the sliding straight edge

»	¼	Base dimensions mm	Cross-section mm	Order no.	List price EUR
		60 x 35 x 13	7 x 7 x 100	0394 101	203.00
		40 x 23 x 9	7 x 7 x 60	0394 110	82.00

Accessories	Order no.	Listenpreis EUR
Replacement rule for 0394	0394 104	36.80



0387 Knife edge squares



Model

- Stainless steel
- DIN 875
- Accuracy grade 00
- Angle 90°
- Knife edge on the inside

Delivery

- Cardboard box

**DIN
875**

✕	📏	Length of beams mm	Cross section with narrow beam mm	Cross section with wide beam mm	Order no.	List price EUR
		25 x 20	5 x 3.5	6 x 3.5	0387 200	17.20
		40 x 28	5 x 3.5	8 x 3.5	0387 201	17.20

0387 Inspection square set



Model

- Knife edge squares 0387 200 and 0387 201
- Wooden case

✕	📏	Order no.	List price EUR
		0387 204	40.20

0397 5 piece inspection set



Model

set consisting of:

- Knife edge square, stainless steel 75 x 50 mm
- Knife edge square, stainless steel 40 x 28 mm
- Knife edge square, stainless steel 25 x 20 mm
- Knife edge rule, special steel 100 mm
- Gauge block scriber 60 x 9 x 9 mm

Delivery

- Wooden case

✕	📏	Order no.	List price EUR
		0397 101	177.00



0380 Centre squares



Model

- Special steel
- Factory standard
- With mm graduated scale
- Scale has a satin chrome finish

- For marking the centre of cylindrical workpieces, for example spindles, slices

Delivery

- Cardboard box

	Length of beams mm	For shaft dia. to mm	Order no.	List price EUR
Special steel				
	400 x 250	380.0	0380 108	251.00
	500 x 330	530.0	0380 109	447.00
Special steel, chrome finished				
	100 x 70	90.0	0380 103	55.00
	150 x 130	190.0	0380 104	65.00
	200 x 150	220.0	0380 105	82.00
	250 x 160	230.0	0380 106	90.00
	300 x 180	280.0	0380 107	98.00

0396 Flange squares



Model

- Special steel, zinc coated
- Factory standard
- For accurately aligning flanges e.g. in plumbing and sanitary works in pipeline

Delivery

- Cardboard box
- From blade length 600 mm in transportation box

		Length of beams mm	Cross-section mm	Order no.	List price EUR
		300 x 300	30 x 5	0396 414	14.80
		400 x 400	30 x 5	0396 416	17.60
		500 x 500	30 x 5	0396 418	20.80
	▪	600 x 600	30 x 5	0396 420	26.00
	▪	800 x 800	30 x 5	0396 426	31.20



0395 Mitre squares 120°



Model

- Special steel
- Factory standard

Delivery

- Cardboard box

▶	▫	Length of beams mm	Cross-section mm	Order no.	List price EUR
Flat, without base					
		50 x 50	15 x 5	0395 132	8.30
		75 x 75	18 x 5	0395 133	10.60
		100 x 100	20 x 5	0395 134	12.80

0395 Mitre squares 135°



Model

- Special steel
- Factory standard

Delivery

- Cardboard box

▶	▫	Length of beams mm	Cross-section mm	Order no.	List price EUR
With base					
		120 x 80	20 x 5	0395 142	18.30
		150 x 100	20 x 5	0395 143	20.70
		200 x 130	25 x 5	0395 144	27.10
Flat, without base					
		50 x 50	15 x 5	0395 136	8.30
		75 x 75	18 x 5	0395 137	10.60
		100 x 100	20 x 5	0395 138	12.80
		120 x 80	20 x 5	0395 146	13.50
		150 x 100	20 x 5	0395 147	18.30
		200 x 130	25 x 5	0395 148	24.80



0395 Acute angle squares 60°



Model

- Special steel
- Factory standard

Delivery

- Cardboard box

✕	¼	Length of beams mm	Cross-section mm	Order no.	List price EUR
With base					
		120 x 80	20 x 5	0395 122	25.40
		150 x 100	20 x 5	0395 123	29.10
		200 x 130	25 x 5	0395 124	39.00
Flat, without base					
		120 x 80	20 x 5	0395 126	18.20
		150 x 100	20 x 5	0395 127	20.30
		200 x 130	25 x 5	0395 128	28.60

0395 Acute angle squares 45°



Model

- Special steel
- Factory standard

Delivery

- Cardboard box

✕	¼	Length of beams mm	Cross-section mm	Order no.	List price EUR
With base					
		120 x 80	20 x 5	0395 102	26.90
		150 x 100	20 x 5	0395 103	29.80
		200 x 130	25 x 5	0395 104	40.20
Flat, without base					
		120 x 80	20 x 5	0395 106	18.90
		150 x 100	20 x 5	0395 107	20.70
		200 x 130	25 x 5	0395 108	29.80



0396 Carpenters squares

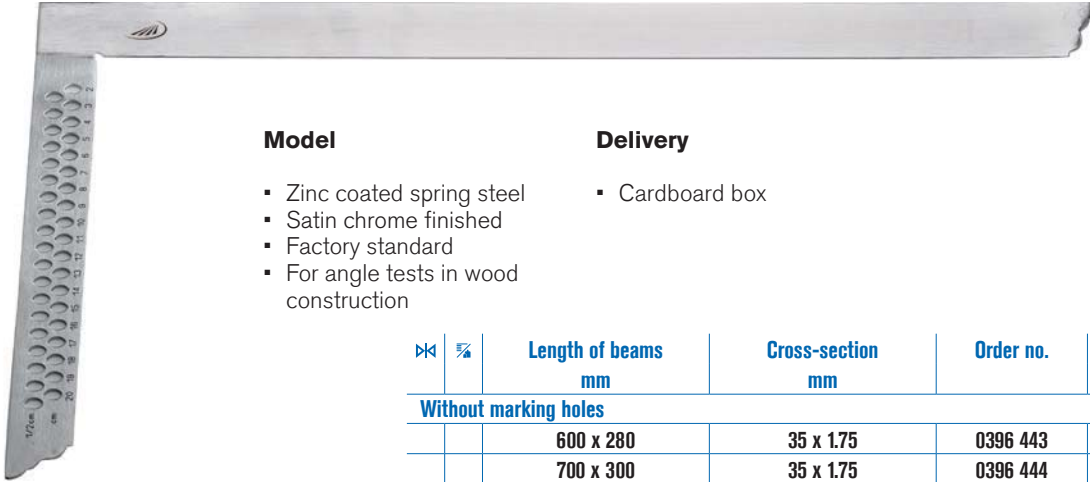

Model

- Zinc coated spring steel
- Satin chrome finished
- Factory standard
- For angle tests in wood construction

Delivery

- Cardboard box

✕	☞	Length of beams mm	Cross-section mm	Order no.	List price EUR
Without marking holes					
		600 x 280	35 x 1.75	0396 443	10.10
		700 x 300	35 x 1.75	0396 444	11.90
		800 x 320	35 x 1.75	0396 445	12.90
		1000 x 380	35 x 1.75	0396 446	16.60
With marking holes					
		600 x 280	35 x 1.75	0396 453	12.70
		700 x 300	35 x 1.75	0396 454	14.30
		800 x 320	35 x 1.75	0396 455	15.90
		1000 x 380	35 x 1.75	0396 456	19.50

0396 Alpha squares with marking holes

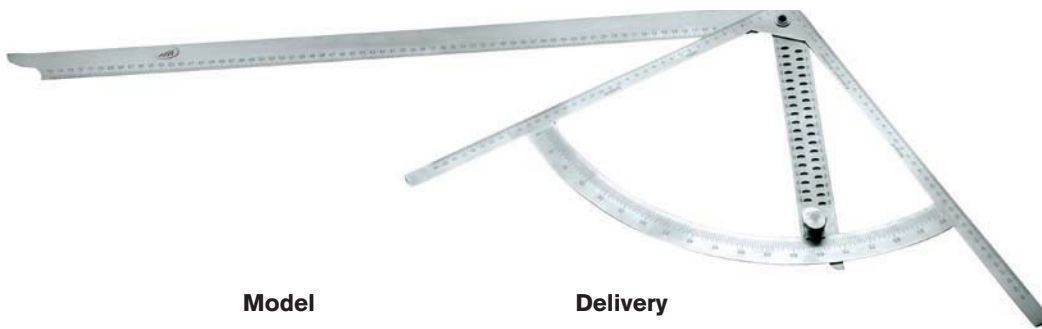

Model

- Stainless steel
- Long blade with mm graduation, short blade used as adjustable protractor and for marking and production of wood joints 0°-90°

Delivery

- Cardboard box

✕	☞	Length of beams mm	Cross-section mm	Order no.	List price EUR
		430 x 795	35	0396 290	92.00



0396 Joiner squares with mitre



Model

- Aluminium
- mm graduation

Delivery

- Cardboard box

	Length of beams mm	Cross section with narrow beam mm	Cross section with wide beam mm	Order no.	List price EUR
	250 x 148	40 x 14	50 x 5	0396 982	11.40
	300 x 164	40 x 14	50 x 5	0396 983	13.50
	400 x 195	40 x 14	50 x 5	0396 984	16.10

0396 Adjustable square



Model

- Special steel, zinc coated
- Satin chrome finished
- Screw hinge
- For transferring, marking and setting of individual angles

Delivery

- Cardboard box

	Length of beams mm	Cross-section mm	Order no.	List price EUR
	200	20 x 8	0396 432	9.40
	250	25 x 8	0396 433	11.60
	300	25 x 8	0396 434	14.20
	400	25 x 8	0396 435	18.20
	500	25 x 8	0396 436	20.30



0003 Wooden cases for squares



☒	☒	Length of beams mm	Internal dimensions L x W x H mm	Order no.	List price EUR
For squares with base					
		150 x 100	160 x 105 x 27	0003 284	6.50
		200 x 130	210 x 135 x 34	0003 286	8.60
		250 x 165	260 x 170 x 38	0003 288	18.50
		300 x 200	312 x 205 x 42	0003 290	18.50
		400 x 265	412 x 270 x 48	0003 292	35.30
		500 x 330	512 x 335 x 54	0003 294	39.80
For flat type squares					
		150 x 100	160 x 105 x 22	0003 283	5.90
		200 x 130	210 x 135 x 27	0003 285	7.40
		250 x 165	260 x 170 x 27	0003 287	8.20
		300 x 200	312 x 205 x 27	0003 289	11.10
		400 x 265	412 x 270 x 27	0003 291	32.00
		500 x 330	512 x 335 x 27	0003 293	35.60
For squares with and without base					
		50 x 40	55 x 45 x 22	0003 280	4.10
		75 x 50	80 x 55 x 22	0003 281	4.50
		100 x 70	105 x 75 x 22	0003 282	4.70



0410 Protractors



Model

- With rivetted hinge
- Special steel, satin chrome finished
- Factory standard
- 0 - 180°

Delivery

- Cardboard box

☒	☒	Length of beams	Graduated arc dia.	Order no.	List price
		mm	mm		EUR
		120	80	0410 301	23.90
		150	120	0410 302	30.10
		200	150	0410 303	34.30
		300	200	0410 304	51.00

0411 Protractors



Model

- Locking screw
- High precision, laser graduated degree scale
- Factory standard
- 0 - 180°

Delivery

- Cardboard box

☒	☒	Length of beams	Graduated arc dia.	Order no.	List price
		mm	mm		EUR
Special steel					
		120	80	0411 101	21.70
		150	120	0411 102	27.10
		200	150	0411 103	34.00
		300	200	0411 104	45.00
		500	300	0411 105	68.00
		600	300	0411 106	79.00
		800	300	0411 107	104.00
		600	400	0411 108	134.00
		800	400	0411 109	142.00
		1000	400	0411 110	148.00
Special steel, satin chrome finished graduated arc					
		120	80	0411 301	24.10
		150	120	0411 302	31.00
		200	150	0411 303	34.50
		300	200	0411 304	49.50
		500	300	0411 305	99.00
		600	300	0411 306	125.00
		800	300	0411 307	135.00
		600	400	0411 308	141.00
		800	400	0411 309	149.00
		1000	400	0411 310	183.00



0412 Protractors



Model

- Locking screw
- Stainless steel
- Factory standard
- 0 - 180°
- High precision, laser graduated degree scale

Delivery

- Cardboard box

☒	☒	Length of beams	Graduated arc dia.	Order no.	List price
		mm	mm		EUR
		120	80	0412 201	34.00
		150	120	0412 202	36.80
		200	150	0412 203	37.80
		300	200	0412 204	53.00

0413 Protractors



Model

- Locking screw
- Special steel
- Factory standard
- 0 - 180°
- High precision, laser graduated degree scale
- Graduated in opposite directions
- Satin chrome finished

Delivery

- Cardboard box



☒	☒	Base dimensions	Length of beams	Order no.	List price
		mm	mm		EUR
		Ø 85	150	0413 301	22.90
		85 x 50	150	0413 302	23.90



0415 Bevel protractors



Model

- Locking screw
- Special steel, pointer arm is satin chrome finished
- Factory standard
- Adjustable stop bar 10° - 170°
- High precision, laser graduated degree scale

Delivery

- Cardboard box

✂	📏	Length of beams	Graduated arc dia.	Order no.	List price
		mm	mm		EUR
		150	100	0415 301	62.00
		300	150	0415 302	97.00
		400	200	0415 303	131.00
		500	250	0415 304	180.00
		600	300	0415 305	204.00

0416 Bevel protractors with double stop rail



Model

- Locking screw
- Special steel, pointer arm is satin chrome finished
- Factory standard
- Adjustable stop bar 10° - 170°
- High precision, laser graduated degree scale
- Two-way adjustable stop bar

Delivery

- Cardboard box

✂	📏	Length of beams	Graduated arc dia.	Order no.	List price
		mm	mm		EUR
		150	100	0416 301	125.00
		300	150	0416 302	163.00
		400	200	0416 303	211.00
		500	250	0416 304	349.00
		600	300	0416 305	405.00

5



0422 Universal bevel protractors with magnifying lens



Model

- Locking screw
- Stainless steel
- Factory standard
- Fine adjustment screw
- Parallax-free reading
- Reading parts are satin chrome finished
- Vernier and scale reading 5 minutes
- Hardened beam

Delivery

- Wooden case

Marked	Marked	Measuring range in °	Blade length mm	Order no.	List price EUR
		4 x 90°	150	0422 501	145.00
		4 x 90°	200	0422 502	153.00
		4 x 90°	300	0422 503	161.00
		4 x 90°	500	0422 504	169.00

0425 DIGI-MET® Universal bevel protractors



Model

- Clamping unit
- Stainless steel
- Factory standard
- reversible measuring range:
 - 1 x 360°
 - 2 x 180°
 - 4 x 90°

Functions



- ON / OFF
- Set to zero at any point
- Data output Opto RS 232

Delivery

- Wooden case

- Reversible indication
 - degree and minutes
 - decimal degree

Marked	Marked	Blade length mm	Order no.	List price EUR
		150	0425 701	1130.00
		200	0425 702	1140.00
		300	0425 703	1150.00



Accessories

Accessories	Order no.	List price EUR
Battery, 3V-Lithium, CR 2032	0220 704	3.70
Data cable opto to RS232	0996 701	74.00
Data cable opto to USB	0996 705	141.00

0425 Replacement blades for 0422 / 0425



Marked	Marked	Blade length mm	Order no.	List price EUR
		150	0425 211	27.50
		200	0425 212	31.00
		300	0425 213	34.70
		500	0425 214	48.90



0420 Universal bevel protractors



Model

- Locking screw
- Stainless steel
- Factory standard
- Vernier scale reading 5 minutes

Delivery

- Cardboard box

⊞	⊞	Measuring range in °	Blade length mm	Order no.	List price EUR
		4 x 90 °	150	0420 201	54.00
		4 x 90 °	200	0420 202	58.00
		4 x 90 °	300	0420 203	62.00

Accessories

	Order no.	List price EUR
Replacement magnifying lense	0420 121	15.60
Angle stop for bevel protractors	0420 122	60.00
Prismatic base	0420 124	85.00
Replacement beam 100 mm	0420 206	17.70
Replacement beam 200 mm	0420 207	18.50
Replacement beam 300 mm	0420 208	18.70



0420121



0420122



0420124



0420206

5



SAMPLES GAUGES

PLUG GAUGES

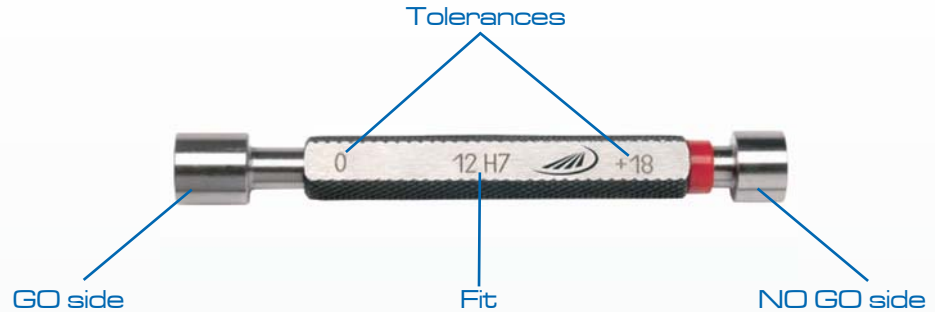

OUR SPECIAL OFFER:

**PLUG GAUGES WITH REQUIRED FIT
OR INDIVIDUAL TOLERANCES
ACCORDING TO YOUR SPECIFICATIONS**

BESTSELLER:

**FEELER GAUGE TAPES
IN SINGLE BOXES**



NOW AVAILABLE FROM **STAINLESS STEEL**



AS **SET** IN OUR CONVENIENT **WALLHOLDER**

Incl. holder for feeler gauge tapes

6. CHAPTER GAUGES, RULES INSPECTION EQUIPMENT

220	Graduated rules
223	Steel scale tapes for circumference and diameter
224	Rules
227	Knife edge rules
228	Inspection plates made from cast iron
229	Lapping and inspection plate
230	Measuring and inspection plates made from granite
231	Angle normal
232	Sinus rules, prisms
236	Sets of parallel blocks
237	Levels
239	Profile gauges, ISO indicators
242	Twist drill grinding and inspection gauges
243	Grinding / Welding gauges
244	Radius / Chamfer gauge
245	Tapered hole gauges
246	Hole gauges
247	Radius gauges
248	Feeler gauges
250	Feeler gauge tapes
252	Comparative surface roughness standards
253	Feeler gauge tapes and precision reference sheets
255	Gauge blocks and accessories
266	Pin gauges
268	Plug gauges, snap gauges
271	Ring gauges



0460 Flexible steel rules

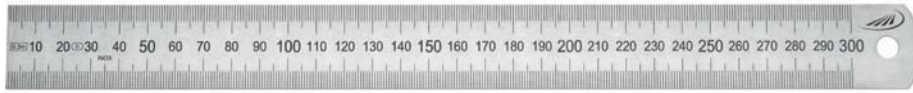

0460 204



0460 222



0460 242

Model

- Stainless spring band steel
- EC grade II
- Rules with special graduations or other scales are available upon request

Model	Length mm	Cross-section mm	Order no.	List price EUR
Scales: mm top and bottom				
	150	13 x 0.5	0460 201	1.00
	200	13 x 0.5	0460 202	1.00
	300	15 x 0.5	0460 204	1.50
	500	20 x 0.5	0460 205	4.10
	1000	20 x 0.5	0460 206	8.80
	300	30 x 1	0460 207	3.10
	500	30 x 1	0460 208	7.40
	1000	30 x 1	0460 209	15.40
	1500	30 x 1	0460 210	24.80
	2000	30 x 1	0460 211	29.80
	3000	30 x 1	0460 212	69.00
▪	3000	30 x 2	0460 213	107.00
Scales: 1/2 mm top, mm bottom				
	150	13 x 0.5	0460 221	1.00
	200	13 x 0.5	0460 222	1.00
	250	15 x 0.5	0460 223	1.50
	300	15 x 0.5	0460 224	1.50
	500	20 x 0.5	0460 225	4.10
	1000	20 x 0.5	0460 226	8.80
	300	30 x 1	0460 227	3.10
	500	30 x 1	0460 228	7.40
	1000	30 x 1	0460 229	15.40
	1500	30 x 1	0460 230	24.80
	2000	30 x 1	0460 231	29.80
	3000	30 x 1	0460 232	69.00
▪	3000	30 x 2	0460 233	107.00
Scales: 1/16", 1/32", 1/64" top; 1/2 mm, 1/1 mm bottom				
	150	13 x 0.5	0460 241	1.00
	200	13 x 0.5	0460 242	1.00
	250	15 x 0.5	0460 243	1.50
	300	15 x 0.5	0460 244	1.50
	500	20 x 0.5	0460 245	4.10
	1000	20 x 0.5	0460 246	8.80
	300	30 x 1	0460 247	3.10
	500	30 x 1	0460 248	7.40
	1000	30 x 1	0460 249	15.40
	1500	30 x 1	0460 250	24.80
	2000	30 x 1	0460 251	29.80
	3000	30 x 1	0460 252	69.00
▪	3000	30 x 2	0460 253	107.00



0460 Flexible steel rules, satin chrome



0460 502



0460 522

Model

- Stainless spring band steel
- Scales satin chrome finished
- EC grade II

		Length mm	Cross-section mm	Order no.	List price EUR
Scales: mm top and bottom					
		150	13 x 0.5	0460 501	2.60
		200	13 x 0.5	0460 502	4.10
		300	15 x 0.5	0460 504	4.70
		500	20 x 0.5	0460 505	10.30
		1000	20 x 0.5	0460 506	20.90
		300	30 x 1	0460 507	5.40
		500	30 x 1	0460 508	11.30
		1000	30 x 1	0460 509	23.60
	▪	1500	35 x 1.5	0460 510	69.00
	▪	2000	35 x 1.5	0460 511	108.00
	▪	3000	35 x 1.3	0460 512	227.00
Scales: 1/2 mm top, mm bottom					
		150	13 x 0.5	0460 521	2.60
		200	13 x 0.5	0460 522	4.10
		300	15 x 0.5	0460 524	4.70
		500	20 x 0.5	0460 525	10.30
		1000	20 x 0.5	0460 526	20.90
		300	30 x 1	0460 527	5.40
		500	30 x 1	0460 528	11.30
		1000	30 x 1	0460 529	23.60

0453 Aluminium straight edges, anodized



0453 422

Model

- Bevelled edge
- Non-glare mm graduation
- Factory standard

		Length mm	Cross-section mm	Order no.	List price EUR
		300	50 x 5	0453 422	8.50
		600	50 x 5	0453 430	12.70
		1000	50 x 5	0453 434	18.70



0451 Graduated straight rules acc. to DIN 866, type A



DIN
866-A

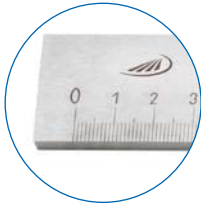

Model

- Both-sided 10 mm protective ends
- mm graduated scale

Delivery

- Cardboard box
- From 2000 mm in transportation box

		Length mm	Cross-section mm	Order no.	List price EUR
Special steel					
		500	30 x 6	0451 101	24.80
		1000	40 x 8	0451 102	57.00
	▪	1500	40 x 8	0451 103	102.00
	▪	2000	50 x 10	0451 104	141.00
	▪	3000	50 x 10	0451 105	292.00
	▪	4000	60 x 12	0451 106	530.00
Stainless steel					
		500	30 x 6	0451 201	43.90
		1000	40 x 8	0451 202	101.00
	▪	1500	40 x 8	0451 203	150.00
	▪	2000	50 x 10	0451 204	263.00
	▪	3000	50 x 10	0451 205	530.00
	▪	4000	60 x 12	0451 206	958.00

0452 Graduated straight rules acc. to DIN 866, type B



DIN
866-B



Model

- Graduated scale begins directly on the end of rule, the other end has a 10 mm protective end
- mm graduated scale

Delivery

- Cardboard box
- From 2000 mm in transportation box

		Length mm	Cross-section mm	Order no.	List price EUR
Special steel					
		500	25 x 5	0452 101	19.50
		1000	30 x 6	0452 103	38.50
	▪	1500	30 x 6	0452 104	56.00
	▪	2000	40 x 8	0452 105	91.00
	▪	2500	40 x 8	0452 106	144.00
	▪	3000	40 x 8	0452 107	159.00
	▪	4000	50 x 10	0452 108	304.00
	▪	5000	60 x 12	0452 109	547.00
Stainless steel					
		500	25 x 5	0452 201	26.00
		1000	30 x 6	0452 203	57.00
	▪	1500	30 x 6	0452 204	97.00
	▪	2000	40 x 8	0452 205	154.00
	▪	2500	40 x 8	0452 206	294.00
	▪	3000	40 x 8	0452 207	305.00
	▪	4000	50 x 10	0452 208	549.00
	▪	5000	60 x 12	0452 209	1046.00





0458 Steel scale tapes for circumference and diameter



0458104



0458102

Model

- Factory standard
- Vernier 0.1 mm
- Main scale graduation 1 mm

Delivery

- Cardboard box

For circumference mm	For dia. mm	Order no.	List price EUR
Spring band steel			
60 - 950	20 - 300	0458 102	36.80
940 - 2200	300 - 700	0458 103	43.90
2190 - 3460	700 - 1100	0458 104	57.00
3450 - 4720	1100 - 1500	0458 105	68.00
4710 - 5980	1500 - 1900	0458 106	82.00
5960 - 7230	1900 - 2300	0458 107	94.00
7220 - 8500	2300 - 2700	0458 108	232.00
8480 - 9760	2700 - 3100	0458 109	249.00
9730 - 11010	3100 - 3500	0458 110	320.00
11000 - 12260	3500 - 3900	0458 111	490.00
12250 - 13500	3900 - 4300	0458 112	500.00
13500 - 14760	4300 - 4700	0458 113	510.00
14760 - 16020	4700 - 5100	0458 114	520.00
16020 - 17270	5100 - 5500	0458 115	530.00
17270 - 18520	5500 - 5900	0458 116	540.00
18350 - 19780	5900 - 6300	0458 117	675.00
Stainless spring band steel			
60 - 950	20 - 300	0458 202	65.00
940 - 2200	300 - 700	0458 203	83.00
2190 - 3460	700 - 1100	0458 204	101.00
3450 - 4720	1100 - 1500	0458 205	133.00
4710 - 5980	1500 - 1900	0458 206	161.00
5960 - 7230	1900 - 2300	0458 207	188.00

0458 Interior circumference tapes



Model

- To measure the internal circumference and the mean diameter of a round, oval or a continuous polygon bore
- Main scale graduation 1 mm

Delivery

- Cardboard box

For circumference mm	For dia. mm	Order no.	List price EUR
720 - 1550	230 - 490	0458 252	295.00
940 - 2200	300 - 700	0458 253	310.00
2190 - 3620	700 - 1100	0458 254	330.00
3450 - 4720	1100 - 1500	0458 255	380.00
4710 - 5980	1500 - 1900	0458 256	415.00
5970 - 7230	1900 - 2300	0458 257	490.00
7220 - 8500	2300 - 2700	0458 258	570.00

Accessories

Expanding collet

Order no.

0458 291

List price EUR

414.00



0454 Straight edges, with bevelled edge



Model

- Special steel
- Satin chrome finished
- Factory standard

Delivery

- Cardboard box
- From 2000 mm in transportation box

	☒ ☒	Length mm	Cross-section mm	Order no.	List price EUR
		400	40 x 5	0454 424	9.00
		500	40 x 5	0454 428	11.20
	▪	1000	40 x 5	0454 434	22.30
	▪	1500	40 x 5	0454 438	40.50
	▪	2000	40 x 5	0454 440	61.00
	▪	3000	50 x 8	0454 444	162.00

0455 Straight edges with bevelled edge, mm graduation



Model

- Special steel
- Satin chrome finished
- Factory standard
- Graduated scale begins directly on the end of rule, the other end has a 10 mm protective end

Delivery

- Cardboard box
- From 2000 mm in transportation box

	☒ ☒	Length mm	Cross-section mm	Order no.	List price EUR
		400	40 x 5	0455 424	16.60
		500	40 x 5	0455 428	20.70
	▪	1000	40 x 5	0455 434	39.30
	▪	1500	40 x 5	0455 438	70.00
	▪	2000	40 x 5	0455 440	103.00
	▪	3000	50 x 8	0455 444	217.00





0464 Steel rules made of special steel, accuracy grade 0



DIN
874

rectangular cross section

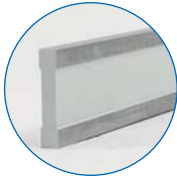

I shaped cross section, 2 hand slots

Model

- Special steel
- DIN 874 Sheet 1

Delivery

- Cardboard box
- From 2000 mm in transportation box

		Length mm	Cross-section mm	Order no.	List price EUR
Special steel, rectangular cross section					
		500	50 x 10	0464 101	63.00
		750	50 x 10	0464 102	90.00
		1000	60 x 12	0464 103	141.00
	▪	1500	70 x 15	0464 104	238.00
Special steel, I shaped cross section, 2 hand slots					
	▪	2000	80 x 15	0464 105	427.00
	▪	2500	100 x 16	0464 106	726.00
	▪	3000	120 x 18	0464 107	1114.00
	▪	4000	140 x 20	0464 108	1915.00
	▪	5000	140 x 20	0464 109	2380.00

0465 Steel rules made of special steel, accuracy grade 1



		Length mm	Cross-section mm	Order no.	List price EUR
Special steel, rectangular cross section					
		500	40 x 8	0465 101	31.00
		750	50 x 10	0465 102	51.00
		1000	50 x 10	0465 103	69.00
	▪	1500	60 x 12	0465 104	127.00
Special steel, I shaped cross section, 2 hand slots					
	▪	2000	70 x 15	0465 105	257.00
	▪	2500	80 x 15	0465 106	482.00
	▪	3000	100 x 16	0465 107	827.00
	▪	4000	120 x 18	0465 108	1337.00
	▪	5000	140 x 20	0465 109	2317.00

0466 Steel rules made of special steel, accuracy grade 2



		Length mm	Cross-section mm	Order no.	List price EUR
Special steel, rectangular cross section					
		500	30 x 6	0466 101	21.30
		750	40 x 8	0466 102	37.40
		1000	40 x 8	0466 103	42.60
	▪	1500	50 x 10	0466 104	82.00
	▪	2000	60 x 12	0466 105	111.00
	▪	2500	70 x 15	0466 106	246.00
	▪	3000	80 x 15	0466 107	384.00
Special steel, I shaped cross section, 2 hand slots					
	▪	4000	100 x 16	0466 108	913.00
	▪	5000	120 x 18	0466 109	1375.00



0464 Steel rules made of stainless steel, accuracy grade 0



**DIN
874**

rectangular cross section

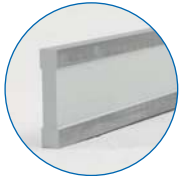

I shaped cross section, 2 hand slots

Model

- DIN 874 Sheet 1
- Stainless steel

Delivery

- Cardboard box
- From 2000 mm in transportation box

▶	▣	Length mm	Cross-section mm	Order no.	List price EUR
Stainless steel, rectangular cross section					
		500	50 x 10	0464 201	100.00
		750	50 x 10	0464 202	136.00
		1000	60 x 12	0464 203	257.00
	▪	1500	70 x 15	0464 204	427.00
Stainless steel, I shaped cross section, 2 hand slots					
	▪	2000	80 x 15	0464 205	790.00
	▪	2500	100 x 16	0464 206	1375.00
	▪	3000	120 x 18	0464 207	2432.00
	▪	4000	140 x 20	0464 208	4338.00
	▪	5000	140 x 20	0464 209	5485.00

0465 Steel rules made of stainless steel, accuracy grade 1



▶	▣	Length mm	Cross-section mm	Order no.	List price EUR
Stainless steel, rectangular cross section					
		500	40 x 8	0465 201	57.00
		750	50 x 10	0465 202	87.00
		1000	50 x 10	0465 203	157.00
	▪	1500	60 x 12	0465 204	246.00
Stainless steel, I shaped cross section, 2 hand slots					
	▪	2000	70 x 15	0465 205	580.00
	▪	2500	80 x 15	0465 206	883.00
	▪	3000	100 x 16	0465 207	1701.00
	▪	4000	120 x 18	0465 208	2505.00
	▪	5000	140 x 20	0465 209	4593.00

0466 Steel rules made of stainless steel, accuracy grade 2



▶	▣	Length mm	Cross-section mm	Order no.	List price EUR
Stainless steel, rectangular cross section					
		500	30 x 6	0466 201	36.80
		750	40 x 8	0466 202	64.00
		1000	40 x 8	0466 203	94.00
	▪	1500	50 x 10	0466 204	196.00
	▪	2000	60 x 12	0466 205	330.00
	▪	2500	70 x 15	0466 206	549.00
	▪	3000	80 x 15	0466 207	784.00
Stainless steel, I shaped cross section, 2 hand slots					
	▪	4000	100 x 16	0466 208	1460.00
	▪	5000	120 x 18	0466 209	2188.00





0512 Knife edge rules



0512 101

**DIN
874**

Model

- DIN 874 Sheet 2, accuracy grade 00
- Thermally insulated
- Pointed tip at one end
- Special steel: glare free and burnished knife edge
- Stainless steel: non glare knife edge

Delivery

- Imitation leather case

		Length mm	Cross-section mm	Order no.	List price EUR
Special steel, hardened and grinded					
		75	25 x 5	0512 101	10.10
		100	25 x 5	0512 102	11.30
		125	25 x 5	0512 103	12.80
		150	25 x 5	0512 104	14.50
		200	29 x 7	0512 105	18.90
		300	29 x 7	0512 106	35.60
		400	33 x 10	0512 107	63.00
		500	33 x 10	0512 108	100.00
Stainless steel, hardened and grinded					
		75	25 x 5	0512 201	13.10
		100	25 x 5	0512 202	15.40
		125	25 x 5	0512 203	16.00
		150	25 x 5	0512 204	17.90
		200	29 x 7	0512 205	20.70
		300	29 x 7	0512 206	45.00
		400	33 x 10	0512 207	82.00
		500	33 x 10	0512 208	111.00
		600	45 x 10	0512 209	215.00
		750	60 x 12	0512 210	436.00
		1000	60 x 12	0512 211	571.00

0512 Wooden cases for knife edge rules



		Length mm	Order no.	List price EUR
		75	0512 601	5.20
		100	0512 602	5.20
		125	0512 603	5.20
		150	0512 604	6.20
		200	0512 605	7.30
		300	0512 606	8.30
		400	0512 607	10.40
		500	0512 608	15.60
		600	0512 609	15.60
		750	0512 610	31.20
		1000	0512 611	36.40



0467 Mounting straight edges



DIN
874



Model

- Special steel
- DIN 874 Sheet 1
- Tolerance 21 µm

	Length mm	Cross-section mm	Order no.	List price EUR
Accuracy grade 0				
	1000	160 x 50	0467 011	621.00
▪	1500	160 x 50	0467 012	888.00
▪	2000	160 x 50	0467 013	1156.00
▪	2500	160 x 50	0467 014	1489.00
▪	3000	180 x 60	0467 015	2492.00
▪	4000	180 x 60	0467 016	3464.00
▪	5000	200 x 80	0467 017	6013.00
Accuracy grade 1				
	1000	100 x 30	0467 111	457.00
▪	1500	100 x 30	0467 112	616.00
▪	2000	120 x 40	0467 113	822.00
▪	2500	120 x 40	0467 114	1125.00
▪	3000	140 x 40	0467 115	1515.00
▪	4000	140 x 40	0467 116	1994.00
▪	5000	140 x 40	0467 117	3160.00

0478 Inspection plates



DIN
876-2

Model

- Special cast iron
- Rigid ripped construction
- milled



	Base dimen- sions mm	Accuracy grade	Order no.	List price EUR
grinded				
	200 x 200	3	0478 312	97.00
	300 x 300	3	0478 315	155.00
▪	400 x 300	3	0478 316	187.00
▪	400 x 400	3	0478 317	224.00
▪	500 x 400	3	0478 318	289.00
▪	500 x 500	3	0478 319	428.00
▪	600 x 500	3	0478 321	471.00
▪	800 x 500	3	0478 324	673.00
▪	1000 x 600	3	0478 327	1069.00



0478 Inspection plates



DIN 876-2

Model

- Special cast iron
- Flatness in accordance to DIN 876-2
- Rigid construction
- *on request
- Stands not included

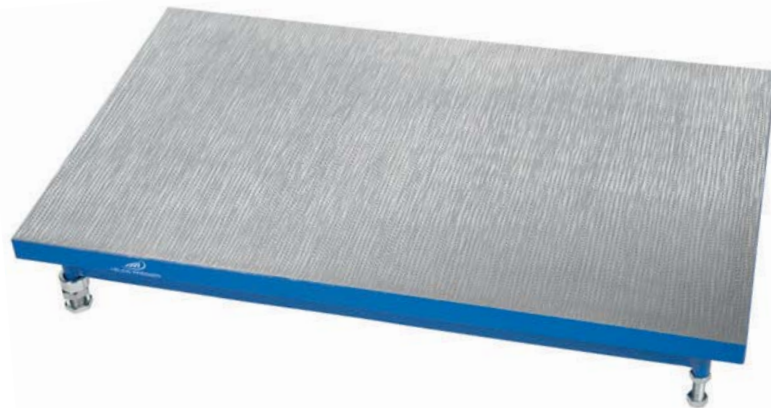

Icon	Base dimensions mm	Accuracy grade	Order no.	List price EUR
Scraped				
	200 x 200	0	0478 012	165.00
	300 x 300	0	0478 015	289.00
▪	400 x 300	0	0478 016	364.00
▪	400 x 400	0	0478 017	471.00
▪	500 x 400	0	0478 018	578.00
▪	500 x 500	0	0478 019	716.00
▪	600 x 500	0	0478 021	898.00
▪	800 x 500	0	0478 024	1283.00*
▪	1000 x 600	0	0478 027	2010.00*
Microground				
▪	200 x 200	1	0478 112	130.00
▪	300 x 300	1	0478 115	214.00
▪	400 x 300	1	0478 116	289.00
▪	400 x 400	1	0478 117	364.00
▪	500 x 400	1	0478 118	406.00
▪	500 x 500	1	0478 119	524.00
▪	600 x 500	1	0478 121	578.00
▪	800 x 500	1	0478 124	962.00
▪	1000 x 600	1	0478 127	1710.00

0482 Lapping and inspection plate

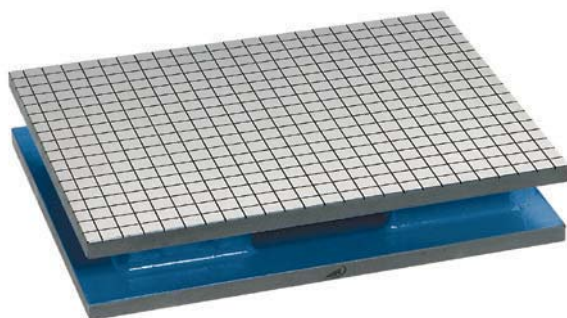

Model

- High grade cast iron
- Finely ground
- One side for lapping with rectangular grooves
- One side as inspection plate flat straight trough

Delivery

- Wooden case

Icon	Base dimensions	Order no.	List price EUR
▪	360 x 260 x 65	0482 101	468.00



0481 Measuring and inspection plates



Model

- Granite
- Flatness in accordance to DIN 876-1
- Acid resistant
- Steel ball inserts

Delivery

- Without base stand (option)

DIN
876-1

▶	☒	Base dimensions mm	Order no.	List price EUR
Accuracy grade 00				
	▪	400 x 400 x 50	0481 023	302.00
	▪	500 x 400 x 90	0481 024	437.00
	▪	600 x 500 x 100	0481 025	657.00
	▪	800 x 600 x 120	0481 028	1091.00
	▪	1000 x 600 x 140	0481 030	1246.00
	▪	1200 x 800 x 160	0481 034	2056.00
Accuracy grade 0				
	▪	400 x 400 x 50	0481 043	257.00
	▪	500 x 400 x 90	0481 044	375.00
	▪	600 x 500 x 100	0481 045	557.00
	▪	800 x 600 x 120	0481 048	935.00
	▪	1000 x 600 x 140	0481 050	1185.00
	▪	1200 x 800 x 160	0481 054	1869.00
Accuracy grade 1				
	▪	400 x 400 x 50	0481 103	220.00
	▪	500 x 400 x 90	0481 104	319.00
	▪	600 x 500 x 100	0481 105	486.00
	▪	800 x 600 x 120	0481 108	810.00
	▪	1000 x 600 x 140	0481 110	1078.00
	▪	1200 x 800 x 160	0481 114	1715.00

0478 Base stand for inspection plates



▶	☒	For plate size mm	Order no.	List price EUR
		400 x 400	0478 907	275.00
		500 x 400	0478 908	275.00
		500 x 500	0478 909	295.00
	▪	600 x 500	0478 911	310.00
	▪	800 x 500	0478 914	350.00
	▪	1000 x 600	0478 917	420.00



0481 Base stand for surface and inspection plates



☒	☒	For plate size mm	Order no.	List price EUR
		400 x 400	0481 160	339.00
		500 x 400	0481 161	351.00
	▪	600 x 500	0481 162	370.00
	▪	800 x 600	0481 165	395.00
	▪	1000 x 600	0481 167	414.00
	▪	1200 x 800	0481 170	470.00

0481 Cabinet for measuring and inspection plates



Model

- Frame is made of angled steel and is completely panelled with steel
- Adjustable 3 point bearing fitting
- 2 adjustable screws for stability
- Lockable doors
- Shelves are removable
- Feet are adjustable to compensate for unevenness of the floor
- 1 door, 1 shelf

☒	☒	For plate size mm	Description	Order no.	List price EUR
	▪	600 x 500	1 door, 1 shelf	0481 184	1098.00
	▪	800 x 600	1 door, 1 shelf	0481 186	1209.00
	▪	1000 x 600	2 doors, 1 drawer, 1 shelf	0481 188	1255.00
	▪	1200 x 800	2 doors, 1 drawer, 1 shelf	0481 190	1403.00

0544 Angle normal 90°, triangular



Model

- Made of black granite
- From 600 x 400 mm with weight reducing holes

☒	☒	Length mm	Width mm	Height mm	Angle accuracy mm	Order no.	List price EUR
		150	40	200	0,002	0544 101	332.00
		200	50	300	0,002	0544 102	512.00
		250	60	400	0,003	0544 103	709.00
		300	60	500	0,003	0544 104	896.00
	▪	400	70	600	0,004	0544 105	1524.00
	▪	500	90	800	0,004	0544 106	2296.00
	▪	600	100	1000	0,004	0544 107	4381.00



0513 Sinus rules



DIN
2273



0513 001



0513 011

Model

- Special steel, hardened
- DIN 2273

Delivery

- With sinus table
- Cardboard box

		Roller spacing mm	Length tolerance mm	Order no.	List price EUR
Without stop type B					
		100	0.002	0513 001	165.00
		200	0.004	0513 002	190.00
With stop type A					
		100	0.002	0513 011	180.00
		200	0.004	0513 012	210.00

0504 V-blocks (pair)



Model

- Special cast iron
- 90° grooves
- Machined in pairs

Delivery

- In pairs
- Cardboard box

		Base dimensions mm	For shaft dia. mm	Accuracy grade	Order no.	List price EUR
Parallelism tolerance < 0.008 mm, V-grooves and base finely grinded						
		100 x 40 x 30	6 - 40	0	0504 012	89.00
		150 x 50 x 40	8 - 50	0	0504 013	139.00
		200 x 70 x 50	8 - 70	0	0504 014	214.00
Parallelism tolerance < 0.016 mm, V-grooves and base grinded						
		100 x 40 x 30	6 - 40	1	0504 112	63.00
		150 x 50 x 40	8 - 50	1	0504 113	84.00
		200 x 70 x 50	8 - 70	1	0504 114	139.00
Parallelism tolerance < 0.064 mm, V-grooves and base milled						
		100 x 40 x 30	6 - 40	3	0504 312	43.70
		150 x 50 x 40	8 - 50	3	0504 313	64.00
		200 x 70 x 50	8 - 70	3	0504 314	106.00



0520 V-blocks (pair)



Model

- Special steel, hardened
- Flatness, parallelism and right-angled tolerance is 0.004 mm
- 90° grooves, machined in pairs
- End face and base are angular

▣	▣	Base dimensions mm	For shaft dia. mm	Order no.	List price EUR
		75 x 35 x 30	5 - 40	0520 101	128.00
		100 x 47 x 40	5 - 55	0520 102	168.00
		150 x 55 x 45	5 - 60	0520 103	223.00
		200 x 65 x 55	5 - 75	0520 104	311.00
		250 x 85 x 70	5 - 100	0520 105	425.00

Delivery

- In pairs
- Cardboard box

0508 Pair of X type V-blocks (parallel)



Model

- Factory standard
- Special cast iron
- 4 x 90° grooves, different sizes

▣	▣	Base dimensions mm	For shaft dia. mm	Accuracy grade	Order no.	List price EUR
Parallelism tolerance < 0.008 mm, V-grooves and base finely grinded						
		60 x 120 x 100	8 - 80	0	0508 011	295.00
		75 x 150 x 130	8 - 130	0	0508 012	355.00
	▪	90 x 200 x 170	12 - 180	0	0508 013	520.00
Parallelism tolerance < 0.016 mm, V-grooves and base grinded						
		60 x 120 x 100	8 - 80	1	0508 111	255.00
		75 x 150 x 130	8 - 130	1	0508 112	315.00
	▪	90 x 200 x 170	8 - 180	1	0508 113	480.00

Delivery

- In pairs
- Cardboard box



0522 Double V-blocks (pairs) with clamp



Model

- Special steel, hardened
- Flatness, parallelism and right-angled tolerance is 0.004 mm
- 2 x 90° grooves
- Machined in pairs
- End face and base are angular

Delivery

- In pairs
- Cardboard box

▶▶	⚙	Base dimensions mm	For shaft dia. mm	Order no.	List price EUR
		50 x 40 x 40	5 - 30	0522 101	196.00
		75 x 55 x 55	5 - 50	0522 102	239.00
		100 x 75 x 75	7 - 70	0522 103	345.00

0524 Double V-blocks (pairs) with clamp lateral tilting



Model

- Special steel, hardened
- Flatness, parallelism and right-angled tolerance is 0.004 mm
- 2 x 90° grooves
- Machined in pairs
- End face and base are angular

Delivery

- In pairs
- Cardboard box

▶▶	⚙	Base dimensions mm	For shaft dia. mm	Order no.	List price EUR
		60 x 58 x 40	5 - 30	0524 101	179.00
		75 x 70 x 54	5 - 30	0524 102	267.00
		100 x 96 x 75	7 - 70	0524 103	401.00

0522 Clamp for double V-blocks (pairs)



Delivery

- In pairs
- Cardboard box

▶▶	⚙	Length mm	Order no.	List price EUR
		50	0522 111	19.70
		75	0522 112	26.00
		100	0522 113	33.20



0525 Adjustable V-blocks 0-60°

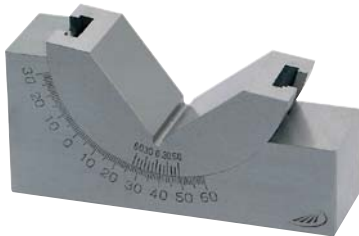

Model

- Special steel, hardened
- Locking device
- Nonius reading

Delivery

- Cardboard box

☒	☒	Base dimensions mm	For shaft dia. mm	Order no.	List price EUR
		75 x 25 x 33	4 - 28	0525 101	115.00
		102 x 30 x 46	4 - 40	0525 102	123.00
		102 x 46 x 46	4 - 40	0525 103	131.00

0527 Magnetic measuring and clamping prism



Model

- Flatness, parallelism and right-angled tolerance is 4 µm
- Magnet can be switched ON/OFF
- Magnetic force 600 N

Delivery

- Cardboard box

☒	☒	Base dimensions mm	For shaft dia. mm	Order no.	List price EUR
Special steel					
		80 x 67 x 99	6 - 66	0527 101	326.00
		100 x 70 x 96	6 - 70	0527 102	452.00
Special steel, hardened					
		80 x 67 x 99	6 - 66	0527 107	387.00
		100 x 70 x 96	6 - 70	0527 108	539.00

0527 Magnetic measuring and clamping prism (pairs)



Model

- Grinded in pairs

Delivery

- In pairs
- Cardboard box

☒	☒	Base dimensions mm	For shaft dia. mm	Order no.	List price EUR
Special steel					
		80 x 67 x 96	6 - 66	0527 104	641.00
		100 x 70 x 96	6 - 70	0527 105	896.00
Special steel, hardened					
		80 x 67 x 96	6 - 66	0527 110	823.00
		100 x 70 x 96	6 - 70	0527 111	1066.00



0536 Set of parallel blocks



0536 202



0536 211

Model

- Special steel, hardened

Delivery

- Wooden case

✕	¼	Measuring range mm	Height mm	Width mm	Number of blocks	Height tolerance µm	Order no.	List price EUR
Set consists of 9 pairs, length 100 mm								
		10 - 42	10 / 14 / 18 / 22 / 26 / 30 / 34 / 38 / 42	4	9	± 5	0536 220	99.00
Set consists of 9 pairs, length 150 mm								
		10 - 42	10 / 14 / 18 / 22 / 26 30 / 34 / 38 / 42	4	9	± 5	0536 230	135.00
Set consists of 12 pairs, length 120 mm								
		14 - 40	14 / 16 / 18 / 20 22 / 24 / 26 / 28 30 / 32 / 35 / 40	10	12	± 5	0536 201	375.00
Set consists of 14 pairs, length 150 mm								
		14 - 50	14 / 16 / 18 / 20 22 / 24 / 26 / 28 30 / 32 / 35 / 40 45 / 50	10	14	± 5	0536 202	420.00
Set consists of 20 pairs, length 100 mm								
		2 - 24	5 / 10 / 15 / 20 6 / 11 / 16 / 21 7 / 12 / 17 / 22 8 / 13 / 18 / 23 9 / 14 / 19 / 24	2 3 4 5 6	20	± 5	0536 211	524.00
Set consists of 24 pairs, length 125 mm								
		8 - 42	11 / 16 / 21 / 26 / 31 / 36 13 / 18 / 23 / 28 / 33 / 38 15 / 20 / 25 / 30 / 35 / 40 17 / 22 / 27 / 32 / 37 / 42	8 10 12 14	24	± 5	0536 212	619.00
Set consists of 24 pairs, length 150 mm								
		8 - 42	11 / 16 / 21 / 26 / 31 / 36 13 / 18 / 23 / 28 / 33 / 38 15 / 20 / 25 / 30 / 35 / 40 17 / 22 / 27 / 32 / 37 / 42	8 10 12 14	24	± 5	0536 213	624.00



0550 Machine levels

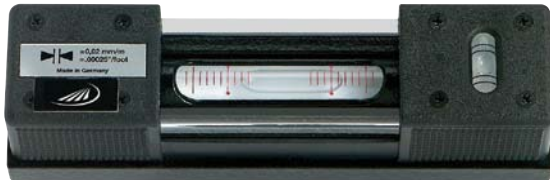

DIN 877

Model

- DIN 877
- V-groove in the base
- Longitudinal level grinded and graduated
- Transverse level
- Thermally insulated

Delivery

- Case

☒	☒	Length mm	Order no.	List price EUR
Reading 0.02 mm/m				
		160	0550 021	255.00
		200	0550 022	280.00
		250	0550 023	305.00
		300	0550 024	330.00
Reading 0.1 mm/m				
		160	0550 101	180.00
		200	0550 102	205.00
		250	0550 103	230.00
		300	0550 104	255.00
Reading 0.3 mm/m				
		160	0550 131	140.00
		200	0550 132	165.00
		250	0550 133	190.00
		300	0550 134	215.00

0551 Crankpin levels



DIN 877

Model

- DIN 877
- With a longitudinal and a transverse level
- Longitudinal level grinded and graduated

Delivery

- Case

☒	☒	Length mm	Order no.	List price EUR
Reading 0.04 mm/m				
		90	0551 002	270.00
		120	0551 003	322.00
Reading 0.1 mm/m				
		90	0551 012	171.00
		120	0551 013	192.00
Reading 0.2 mm/m				
		60	0551 021	161.00



0556 Frame levels



DIN
877



Model

- DIN 877
- V-grooves on 3 sides
- Longitudinal level
- Grinded and graduated
- Transverse level
- Thermally insulated

Delivery

- Case

▶	🏠	Base dimensions mm	Order no.	List price EUR
Reading 0.02 mm/m				
		150 x 150	0556 022	490.00
		200 x 200	0556 023	560.00
		300 x 300	0556 024	790.00
Reading 0.1 mm/m				
		100 x 100	0556 101	300.00
		150 x 150	0556 102	350.00
		200 x 200	0556 103	440.00
		300 x 300	0556 104	700.00
Reading 0.3 mm/m				
		100 x 100	0556 131	250.00
		150 x 150	0556 132	300.00
		200 x 200	0556 133	460.00
		300 x 300	0556 134	550.00

0560 Protractor level



Model

- Made of special steel
- With degree scale
- Flat base
- 1° to 0-90°
- Ideal for levelling, determining centre points and adjusting angles

Delivery

- Case

▶	🏠	Base dimensions mm	Readings minutes	Order no.	List price EUR
Reading 0.04 mm/m					
		200 x 200	6	0560 001	294.00

0563 Magnetic angle gauge



Model

- Centre punch
- Dial face 360°
- Magnetic 90° splayed base

Delivery

- Cardboard box

▶	🏠	Order no.	List price EUR
		0563 001	400.00



0580 Combined lathe and thread cutting gauge



Model

- Special steel
- Cuts for trapezoidal (Acme), Whitworth and metric threads

Base dimensions mm	Measuring range	Order no.	List price EUR
90 x 40 x 2	40-80°	0580 101	7.10

0580 Combined lathe and thread cutting gauge



Model

- Special steel
- Cuts for trapezoidal (Acme), Whitworth and metric threads
- With clearance angle

Base dimensions mm	Measuring range	Order no.	List price EUR
90 x 40 x 2	0-30° and 40-80°	0580 111	10.30

0580 Combined lathe and thread cutting gauge



Model

- Special steel
- For square threads and trapezoidal threads, Whitworth and metric threads

Base dimensions mm	Order no.	List price EUR
90 x 40 x 2	0580 121	7.20

0580 Universal thread cutting gauge

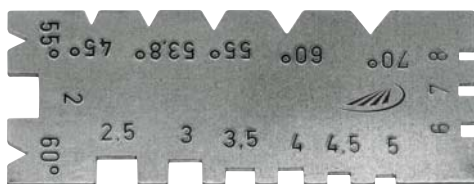

Model

- Special steel
- For V-threads and square threads

Base dimensions mm	Order no.	List price EUR
60 x 25 x 2	0580 151	3.00



0595 ACME Thread gauge



Model

- Special steel
- Cuts for trapezoidal threads

		Base dimensions mm	Order no.	List price EUR
⌘	¼	60 x 20 x 2	0595 130	3.00

0595 Thread cutting gauge



Model

- Special steel
- Cuts for Whitworth or metric threads

		Base dimensions mm	Order no.	List price EUR
⌘	¼			
		Metric ISO - threads 60°		
		74 x 24 x 2	0595 142	2.60
		Whitworth - threads 55°		
		74 x 24 x 2	0595 140	2.60



0581 DIN thread conversion and fit slide rules

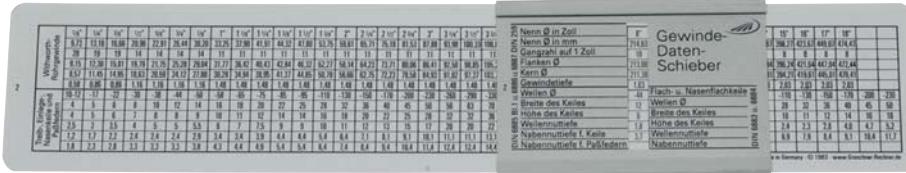

0581 101



0581 123

Model

- For reading the most important theoretical dimensions of thread tolerance

Description	Order no.	List price EUR
Aluminium anodized		
Fine thread slide rule	0581 101	20.70
DIN thread slide rule	0581 103	14.00
DIN fit slide rule	0581 105	19.20
Plastic		
DIN thread slide rule	0581 123	10.10
DIN fit slide rule	0581 125	8.80

0582 ISO thread converter - Filetor



Model

- For direct reading of all standard information for determining of threads
- Plastic housing

Base dimensions mm	Order no.	List price EUR
60 x 30 x 110	0582 110	59.00

0582 ISO tolerance indicator - Tolerator



Model

- For direct reading of all standard information of all ISO-tolerance values
- Plastic housing

Base dimensions mm	Order no.	List price EUR
60 x 30 x 110	0582 120	59.00



0582 mm/inch converter



Model

- Direct reading of inch to millimeter conversion
- Plastic housing

Marked	Marked	Base dimensions mm	Order no.	List price EUR
		60 x 30 x 110	0582 130	59.00

0589 Profile gauge



Model

- Spring pins
- Pin-dia. 1.0 mm

Marked	Marked	Base dimensions mm	Order no.	List price EUR
		154 x 85	0589 101	16.20
		350 x 150	0589 103	49.50

0590 Twist drill grinding gauge

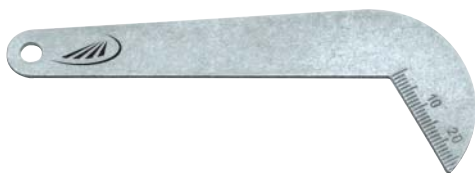

Model

- Special steel
- For twist drills
- Acute angle of 118°

Marked	Marked	Max. Diameter mm	Order no.	List price EUR
		50	0590 101	1.70

0590 Twist drill grinding and inspection gauge



Model

- Special steel
- Measure the length of the cutting edge and the cutting angle of 118°
- Locking screw

Marked	Marked	Readings mm	Max. Diameter mm	Order no.	List price EUR
		0.10	50	0590 111	62.00



0590 Universal grinding gauge



Model

- Special steel
- Scales in mm graduation
- Angles 120°. 118°. 90°. 60° and 55°

✕	☒	Base dimensions	Order no.	List price EUR
		95 x 63 x 2	0590 151	3.30

0595 Welding gauge blank



Model

- Special steel
- Pure
- For easy testing of fillet weld thicknesses of rectangular parts

✕	☒	For measuring range mm	Order no.	List price EUR
		3 - 12	0595 110	12.70

0595 Welding gauge blank



Model

- Aluminium
- Pure, for fast reading of the weld dimensions

✕	☒	For measuring range mm	Order no.	List price EUR
		0 - 5	0595 115	3.60

0595 Welding gauge



Model

- Stainless steel
- Reading accuracy 0.2 mm
- Easy to read the result due to the reference line in the reading window
- Quick and easy inspection of welding seam heights

✕	☒	Base dimensions	Order no.	List price EUR
		108 x 81.5 x 3.2	0595 251	87.00



0595 Welding gauge

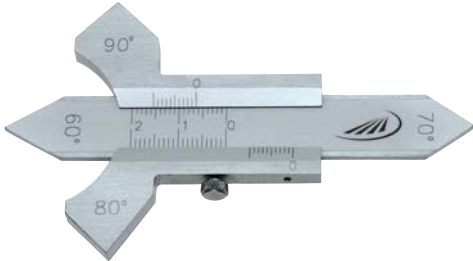

Model

- Special steel
- Locking screw
- Angle 60°, 70°, 80° and 90°; to measure the height of flat welds and fillet weld thicknesses

▶	▶	Measuring range mm	Readings mm mm	Order no.	List price EUR
		20	0.10	0595 101	20.30

0597 Radius gauge



Model

- To determine radius size work-pieces
- Stainless steel
- Reading parts are satin chrome finished

Delivery

- Wooden case

▶	▶	Measuring range mm	Readings mm mm	Order no.	List price EUR
		0 - 10	0.10	0597 305	168.00

0597 Chamfer gauge

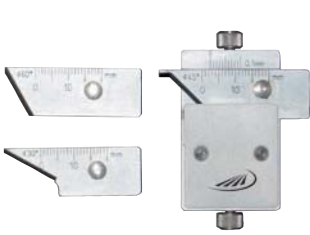

Model

- Stainless steel
- Reading 0.1 mm
- Reading parts are satin chrome finished
- For simultaneously testing of the chamfer angle and the dimensional accuracy
- Dimensions: 48 x 30 x 8.5 mm

Delivery

- 3 interchangeable blades: 30°, 45°, 60°

▶	▶	Measuring range mm	Readings mm mm	Order no.	List price EUR
		0 - 10	0.10	0597 301	168.00



0598 Tapered hole gauges



Model

- Reading parts are non glare matted
- Special steel

☒	☒	Measuring range mm	Readings mm	Order no.	List price EUR
Special steel					
		0.5 - 11	0.10	0598 101	46.80
		0.5 - 7	0.10	0598 103	46.80
		2 - 7	0.10	0598 105	46.80
Plastic					
		0.5 - 11	0.10	0598 601	46.80

0599 Nozzle / small hole gauges



Model

- Special steel
- Reading 0.1 mm
- Cone 1:10
- Nickel plated housing

☒	☒	Measuring range mm	Readings mm	Order no.	List price EUR
		0 - 3	0.10	0599 101	46.80
		0 - 5	0.10	0599 102	57.00

0599 Nozzle gauges

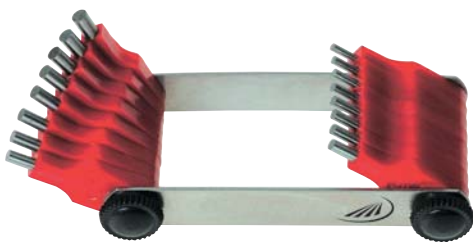

Model

- With steel pins
- Plastic handle
- Manufacturing tolerance ± 0.01 mm

☒	☒	Measuring range mm	Increment mm	Number of pins	Order no.	List price EUR
		0.45 - 1.5	0.05	20	0599 151	6.80
		1.5 - 3	0.1	16	0599 152	6.80



0600 Tapered hole gauges



0600 101



0600 111

Model

- Reading 0.1 mm

Marked	Marked	Measuring range mm	Order no.	List price EUR
Special steel, flat				
		1 - 15	0600 101	24.80
		15 - 30	0600 102	31.00
		30 - 45	0600 103	33.20
Hardened stainless steel, round, knurled handle				
		1 - 6	0600 111	53.00
		4 - 15	0600 112	70.00
		14 - 30	0600 113	146.00
		30 - 45	0600 114	227.00
		45 - 60	0600 115	365.00

0601 Drill and steel wire hole gauges (millimeter)

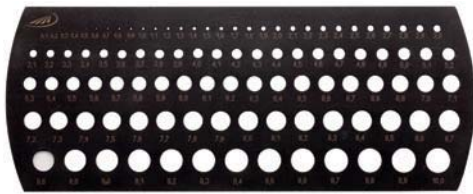

Model

- Special steel, nitrided

Marked	Marked	Measuring range mm	Increment mm	Order no.	List price EUR
		0.1 - 10	0.1	0601 103	87.00
		3 - 10	0.1	0601 120	66.00

0604 Radius gauges



Model

- Concave and convex
- Locking nut
- Milled finish

Marked	Marked	Measuring range mm	Number of blades	Order no.	List price EUR
Special steel					
		1 - 7	17	0604 002	6.50
		7.5 - 15	16	0604 004	7.20
		15.5 - 25	15	0604 006	7.20
Stainless steel					
		1 - 7	17	0604 202	8.60
		7.5 - 15	16	0604 204	10.70
		15.5 - 25	15	0604 206	10.70



0604 Precision individual radius gauges

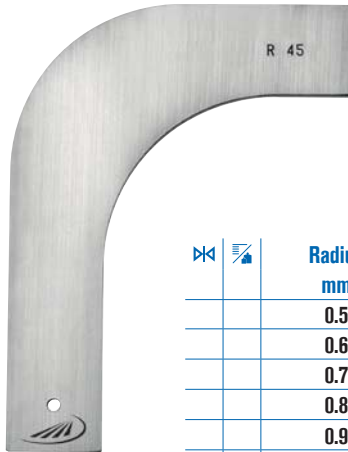

Model

- Special steel
- Factory standard
- Fine grinded
- For internal and external radii
- Custom sizes are available upon request

✕	☒	Radius mm	Order no.	List price EUR
		0.5	0604 013	51.00
		0.6	0604 014	51.00
		0.7	0604 015	51.00
		0.8	0604 016	51.00
		0.9	0604 017	51.00
		1.0	0604 018	51.00
		1.5	0604 019	51.00
		2.0	0604 020	51.00
		2.5	0604 021	51.00
		3.0	0604 022	51.00
		3.5	0604 023	51.00
		4.0	0604 024	51.00
		4.5	0604 025	33.00
		5.0	0604 026	33.00
		5.5	0604 027	33.00
		6.0	0604 028	33.00
		6.5	0604 029	33.00
		7.0	0604 030	33.00
		7.5	0604 031	33.00
		8.0	0604 032	33.00
		8.5	0604 033	33.00
		9.0	0604 034	33.00
		9.5	0604 035	33.00
		10.0	0604 036	33.00
		10.5	0604 037	34.70
		11.0	0604 038	34.70
		11.5	0604 039	34.70
		12.0	0604 040	34.70
		12.5	0604 041	34.70
		13.0	0604 042	34.70
		13.5	0604 043	34.70
		14.0	0604 044	34.70
		14.5	0604 045	34.70
		15.0	0604 046	34.70
		15.5	0604 047	36.60
		16.0	0604 048	36.60
		16.5	0604 049	36.60
		17.0	0604 050	36.60
		17.5	0604 051	36.60
		18.0	0604 052	36.60
		18.5	0604 053	36.60
		19.0	0604 054	36.60

✕	☒	Radius mm	Order no.	List price EUR
		19.5	0604 055	36.60
		20.0	0604 056	36.60
		21.0	0604 057	38.10
		22.0	0604 058	38.10
		23.0	0604 059	38.10
		24.0	0604 060	38.10
		25.0	0604 061	38.10
		26.0	0604 062	38.10
		27.0	0604 063	38.10
		28.0	0604 064	38.10
		29.0	0604 065	38.10
		30.0	0604 066	38.10
		31.0	0604 067	41.60
		32.0	0604 068	41.60
		33.0	0604 069	41.60
		34.0	0604 070	41.60
		35.0	0604 071	41.60
		36.0	0604 072	41.60
		37.0	0604 073	41.60
		38.0	0604 074	41.60
		39.0	0604 075	41.60
		40.0	0604 076	41.60
		41.0	0604 077	50.00
		42.0	0604 078	50.00
		43.0	0604 079	50.00
		44.0	0604 080	50.00
		45.0	0604 081	50.00
		46.0	0604 082	50.00
		47.0	0604 083	50.00
		48.0	0604 084	50.00
		49.0	0604 085	50.00
		50.0	0604 086	50.00
		55.0	0604 087	54.00
		60.0	0604 088	57.00
		65.0	0604 089	60.00
		70.0	0604 090	69.00
		75.0	0604 091	69.00
		80.0	0604 092	69.00
		85.0	0604 093	69.00
		90.0	0604 094	69.00
		95.0	0604 095	69.00
		100.0	0604 096	69.00



0605 Screw pitch gauges



☒	☒	Measuring range mm	Number of devices	Description	Order no.	List price EUR
		0.25 - 6	24	Metric threads according to ISO	0605 101	2.40
		0.4 - 7	20	Combined metric threads according to SI System	0605 102	2.20
		4 - 62	28	Whitworth threads according to DIN	0605 103	2.20
		8 - 28	6	Whitworth pipe threads	0605 104	2.20
		0.4 - 7.0 / 4 - 62	48	Combined metric SI and Whitworth threads	0605 105	3.30
		0.25 - 6.00 / 4 - 62	52	Combined metric and Whitworth	0605 106	3.50
		0.25 - 6.00 / 4 - 62 / 8 - 28	58	Metric Whitworth and pipe threads	0605 107	4.90
		4 - 42	30	US - threads	0605 108	2.90
		10 - 40	14	US - threads SAE	0605 109	3.10
		4 - 64	22	UNC - threads	0605 110	2.90
		12 - 80	16	UNF - threads	0605 111	2.90
		4 - 26	20	BSF - threads	0605 112	3.30

0606 / 0607 Feeler gauges



0606 121



0607 201



0607 401

Model

- Conical blades
- Width 10mm
- Blade length 100
- Locking nut

☒	☒	Measuring range mm	Number of blades	Order no.	List price EUR
Spring band steel					
		0.03 - 0.1	8	0606 121	1.50
		0.05 - 0.5	8	0606 123	1.50
		0.05 - 1	13	0606 127	1.50
		0.05 - 1	20	0606 130	2.40
		0.1 - 2	20	0606 131	5.90
		0.1 - 0.5	21	0606 132	2.90
		0.05 - 2	21	0606 133	5.40
		0.03 - 1	32	0606 136	4.90
Stainless spring band steel					
		0.05 - 0.5	8	0607 201	3.70
		0.05 - 1	13	0607 202	5.90
		0.05 - 1	20	0607 203	8.40
Brass (anti-magnetic)					
		0.05 - 0.5	8	0607 401	6.30
		0.05 - 1	13	0607 402	7.80
		0.05 - 1	20	0607 403	11.10



0606 Feeler gauges, long version



Model

- Cylindrical blades
- Width 13 mm

⌘	☒	Measuring range mm	Length mm	Number of blades	Order no.	List price EUR
		0.05 - 0.5	150	8	0606 150	3.30
		0.05 - 0.5	200	8	0606 152	3.90
		0.05 - 0.5	300	8	0606 154	5.70
		0.05 - 1	200	13	0606 160	8.50
		0.05 - 1	300	13	0606 162	9.80
		0.05 - 1	200	20	0606 170	10.30
		0.05 - 1	300	20	0606 172	13.00
		0.1 - 2	200	20	0606 176	17.20
		0.1 - 2	300	20	0606 178	25.10

0608 Feeler gauge



NEW

Model

- Conical blade
- Width 10 mm

⌘	☒	Measuring range mm	Number of blades	Order no.	List price EUR
		0.1 - 0.4	6	0608 140	1.85
		0.05 - 1	13	0608 143	4.45
		0.05 - 1	20	0608 144	6.95
		0.03 - 1	32	0608 149	15.95



0611 Feeler gauge tapes in single boxes



Model

- Hardened carbon steel
- Width 12.7 mm
- Length 5 m
- Tape from 0.08 mm upwards marked with dimension

Delivery

- Plastic box

☒	☒	Nominal size mm	Order no.	List price EUR
		0.005	0611 300	76.00
		0.01	0611 501	30.00
		0.02	0611 502	24.90
		0.03	0611 503	8.60
		0.04	0611 504	8.60
		0.05	0611 505	6.50
		0.06	0611 506	6.80
		0.07	0611 507	6.80
		0.08	0611 508	6.80
		0.09	0611 509	6.80
		0.1	0611 510	5.80
		0.12	0611 512	5.80
		0.15	0611 515	5.80
		0.18	0611 518	7.60
		0.2	0611 520	5.80
		0.25	0611 525	5.80
		0.3	0611 530	6.70
		0.35	0611 535	6.70
		0.4	0611 540	7.70
		0.45	0611 545	7.70
		0.5	0611 550	7.70
		0.55	0611 552	9.90
		0.6	0611 554	9.90
		0.65	0611 556	9.90
		0.7	0611 558	9.90
		0.75	0611 560	9.90
		0.8	0611 562	9.90
		0.85	0611 564	10.10
		0.9	0611 566	10.60
		0.95	0611 568	10.60
		1	0611 570	10.60

0611 Set of feeler gauge tapes in wallholder



Model

- Refillable with selected feeler gauges
- Wall holder made of steel, gloss coated
- With size labels

Delivery

- With holder and mounting fittings

☒	☒	Base dimensions mm	Measuring range mm	Number of boxes	Order no.	List price EUR
		330 x 100 x 110	0.01 - 0.25	15	0611 180	149.00
		330 x 210 x 220	0.3 - 1	15	0611 190	169.00



0612 Feeler gauge tapes in single boxes - INOX



NEW

Model

- Stainless steel
- Width 12.7 mm
- Length 5 m
- Tape from 0.08 mm upwards marked with dimension

Delivery

- Plastic box

✕	☒	Nominal size mm	Order no.	List price EUR
		0.01	0612 501	39.50
		0.02	0612 502	33.00
		0.03	0612 503	11.50
		0.04	0612 504	11.50
		0.05	0612 505	8.50
		0.06	0612 506	8.90
		0.07	0612 507	8.90
		0.08	0612 508	8.90
		0.09	0612 509	8.90
		0.1	0612 510	7.70
		0.12	0612 512	7.70
		0.15	0612 515	7.70
		0.18	0612 518	9.90
		0.2	0612 520	7.70
		0.25	0612 525	7.70

0612 Set of feeler gauge tapes in wallholder - INOX



Model

- Refillable with selected feeler gauges
- Wall holder made of steel, gloss coated
- With size labels

Delivery

- With holder and mounting fittings

✕	☒	Base dimensions mm	Measuring range mm	Number of boxes	Order no.	List price EUR
		330 x 100 x 110	0.01 - 0.25	15	0612 180	195.00

0611 Holder for feeler gauge tape



Model

- Without magnet

✕	☒	Base dimensions mm	Order no.	List price EUR
		125 x 17	0611 195	2.60



0609 8 piece gauge set



NEW

Model

- Universal grinding gauge – thickness 2 mm, scales in mm graduation, angles 120°, 118°, 90°, 60° and 55°, special steel
- Welding gauge – measuring range 20 mm, reading 0.1mm, locking screw, special steel
- Radius gauge – 17 blades, concave and convex, locking nut, stainless steel, measuring range 1.0 – 7.0 mm
- Radius gauge – 16 blades, concave and convex, locking nut, stainless steel, measuring range 7.5 – 15.0 mm
- Radius gauge – 15 blades, concave and convex, locking nut, stainless steel, measuring range 15.5 – 25.0 mm
- Screw pitch gauge – 24 blades, for metric threads according to ISO, range 0.25 – 6.0 mm
- Screw pitch gauge – 28 blades, for Whitworth threads according to DIN, range 4 - 62
- Feeler gauge - 20 conical blades, length 100 mm, range 0.05 - 1.00, stainless steel, locking nut

Delivery

- Wooden box set

✕	🏠	Order no.	List price EUR
		0609 190	79.00

0584 Comparative surface roughness standards

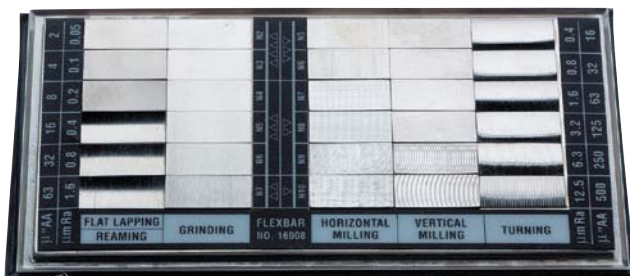

Model

- 6 manufacturing processes
- 30 comparative standards

Delivery

- Plastic case

✕	🏠	Order no.	List price EUR
		0584 101	304.00





0613 Feeler gauge tapes



Nominal size mm	Brass, width 150 mm length 5 m		Carbon steel, width 25 mm length 5 m		Carbon steel, width 50 mm length 5 m		Stainless steel, width 100 mm length 5 m		Stainless steel, width 150 mm length 5 m	
	Order no.	List price EUR	Order no.	List price EUR	Order no.	List price EUR	Order no.	List price EUR	Order no.	List price EUR
0.01			0613 107	65.00	0613 207	94.00				
0.02			0613 109	35.20	0613 209	51.00	0613 309	90.00		
0.025	0613 512	102.00							0613 412	103.00
0.03			0613 114	24.80	0613 214	35.60				
0.04			0613 116	24.80	0613 216	35.60				
0.05	0613 518	82.00	0613 118	24.80	0613 218	35.60	0613 318	54.00	0613 418	83.00
0.06			0613 120	16.90	0613 220	24.30				
0.07			0613 122	16.90	0613 222	24.30				
0.075	0613 524	82.00							0613 424	83.00
0.08			0613 126	16.90	0613 226	24.30				
0.09			0613 128	16.90	0613 228	24.30				
0.1	0613 530	78.00	0613 130	17.50	0613 230	25.20	0613 330	51.00	0613 430	79.00
0.12					0613 232	25.20				
0.15	0613 534	78.00	0613 134	17.50	0613 234	25.20	0613 334	51.00	0613 434	79.00
0.18					0613 236	25.20				
0.2	0613 538	97.00	0613 138	17.50	0613 238	25.20	0613 338	65.00	0613 438	99.00
0.25	0613 540	97.00			0613 240	25.20			0613 440	99.00
0.3	0613 542	97.00	0613 142	17.50	0613 242	25.20	0613 342	65.00	0613 442	99.00
0.35					0613 244	27.50				
0.4	0613 546	108.00	0613 146	19.40	0613 246	27.50	0613 346	74.00	0613 446	109.00
0.45					0613 248	27.50				
0.5	0613 550	127.00	0613 150	19.40	0613 250	27.50	0613 350	84.00	0613 450	128.00
0.6			0613 152	31.00	0613 252	44.80	0613 352	101.00		
0.7			0613 154	31.00	0613 254	44.80	0613 354	101.00		
0.8			0613 156	31.00	0613 256	44.80	0613 356	121.00		
0.9			0613 158	31.00	0613 258	44.80	0613 358	121.00		
1			0613 160	31.00	0613 260	44.80	0613 360	138.00		



0613 Precision reference sheets

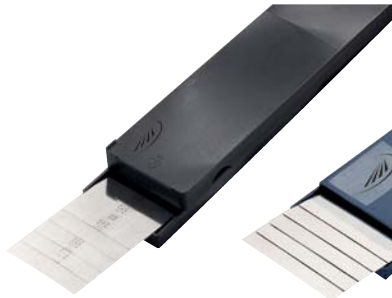

0613 607



0613 709



0613 812



0613 912

Nominal size mm	Carbon steel, 50 x 300 mm 10 pieces		Brass, 150 x 500 mm 5 pieces		Stainless steel, 100 x 500 mm 5 pieces		Stainless steel, 150 x 500 mm 5 pieces	
	Order no.	List price EUR	Order no.	List price EUR	Order no.	List price EUR	Order no.	List price EUR
0.01	0613 607	65.00						
0.02	0613 609	35.20			0613 709	48.50		
0.025			0613 912	54.00			0613 812	54.00
0.03	0613 614	24.80						
0.04	0613 616	24.80						
0.05	0613 618	24.80	0613 918	43.20	0613 718	29.40	0613 818	43.70
0.06	0613 620	16.90						
0.07	0613 622	16.90						
0.075			0613 924	43.20			0613 824	43.70
0.08	0613 626	16.90						
0.09	0613 628	16.90						
0.1	0613 630	17.50	0613 930	41.00	0613 730	27.50	0613 830	41.40
0.12	0613 632	17.50						
0.15	0613 634	17.50	0613 934	41.00	0613 734	27.50	0613 834	41.40
0.18	0613 636	17.50						
0.2	0613 638	17.50	0613 938	51.00	0613 738	34.70	0613 838	52.00
0.25	0613 640	17.50	0613 940	51.00			0613 840	52.00
0.3	0613 642	17.50	0613 942	51.00	0613 742	34.70	0613 842	52.00
0.35	0613 644	19.40						
0.4	0613 646	19.40	0613 946	60.00	0613 746	39.20	0613 846	60.00
0.45	0613 648	19.40						
0.5	0613 650	19.40	0613 950	69.00	0613 750	44.80	0613 850	70.00
0.6	0613 652	31.00			0613 752	54.00		
0.7	0613 654	31.00			0613 754	54.00		
0.8	0613 656	31.00			0613 756	65.00		
0.9	0613 658	31.00			0613 758	65.00		
1	0613 660	31.00			0613 760	72.00	0613 860	113.00



0623 Individual steel gauge blocks, tolerance class 0

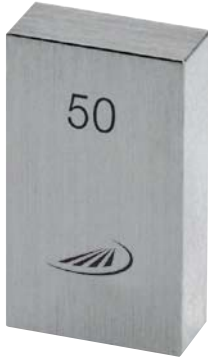

Model

- EN ISO 3650
- Special steel, hardened

Nominal size mm	Order no.	List price EUR
0.5	0623 100	40.50
1.0	0623 102	34.30
1.001	0623 104	34.30
1.002	0623 106	34.30
1.003	0623 108	34.30
1.004	0623 110	34.30
1.005	0623 112	34.30
1.006	0623 114	34.30
1.007	0623 116	34.30
1.008	0623 118	34.30
1.009	0623 120	34.30
1.01	0623 122	34.30
1.02	0623 130	34.30
1.03	0623 135	34.30
1.04	0623 140	34.30
1.05	0623 145	34.30
1.06	0623 150	34.30
1.07	0623 155	34.30
1.08	0623 160	34.30
1.09	0623 165	34.30
1.1	0623 170	34.30
1.11	0623 175	34.30
1.12	0623 180	34.30
1.13	0623 185	34.30
1.14	0623 190	34.30
1.15	0623 195	34.30
1.16	0623 200	34.30
1.17	0623 205	34.30
1.18	0623 210	34.30
1.19	0623 215	34.30
1.2	0623 220	34.30
1.21	0623 225	34.30
1.22	0623 230	34.30
1.23	0623 235	34.30
1.24	0623 240	34.30
1.25	0623 245	34.30
1.26	0623 250	34.30
1.27	0623 255	34.30
1.28	0623 260	34.30
1.29	0623 265	34.30

Nominal size mm	Order no.	List price EUR
1.30	0623 270	34.30
1.31	0623 275	34.30
1.32	0623 280	34.30
1.33	0623 285	34.30
1.34	0623 290	34.30
1.35	0623 295	34.30
1.36	0623 300	34.30
1.37	0623 305	34.30
1.38	0623 310	34.30
1.39	0623 315	34.30
1.40	0623 320	34.30
1.41	0623 325	34.30
1.42	0623 330	34.30
1.43	0623 335	34.30
1.44	0623 340	34.30
1.45	0623 345	34.30
1.46	0623 350	34.30
1.47	0623 355	34.30
1.48	0623 360	34.30
1.49	0623 365	34.30
1.50	0623 370	34.30
1.6	0623 375	34.30
1.7	0623 380	34.30
1.8	0623 385	34.30
1.9	0623 390	34.30
2.0	0623 395	34.30
2.5	0623 400	36.40
3.0	0623 405	36.40
3.5	0623 410	36.40
4.0	0623 415	36.40
4.5	0623 420	36.40
5.0	0623 425	36.40
5.5	0623 430	36.40
6.0	0623 435	36.40
6.5	0623 440	36.40
7.0	0623 445	36.40
7.5	0623 450	36.40
8.0	0623 455	36.40
8.5	0623 460	36.40
9.0	0623 465	36.40

Nominal size mm	Order no.	List price EUR
9.5	0623 470	36.40
10	0623 475	43.60
11	0623 500	43.60
12	0623 510	43.60
13	0623 520	43.60
14	0623 530	43.60
15	0623 540	43.60
16	0623 550	43.60
17	0623 560	43.60
18	0623 570	43.60
19	0623 580	43.60
20	0623 590	43.60
21	0623 600	43.60
22	0623 610	43.60
23	0623 620	43.60
24	0623 630	43.60
25	0623 640	43.60
30	0623 650	52.00
35	0623 660	52.00
40	0623 670	52.00
50	0623 680	52.00
60	0623 690	52.00
70	0623 700	52.00
80	0623 710	64.00
90	0623 720	64.00
100	0623 730	77.00
125	0623 740	272.00
150	0623 750	272.00
175	0623 760	272.00
200	0623 770	324.00
300	0623 780	463.00
400	0623 790	601.00
500	0623 800	831.00
600	0623 810	1298.00
700	0623 820	1346.00
800	0623 830	1662.00
900	0623 840	1970.00
1000	0623 850	2442.00



0624 Individual steel gauge blocks, tolerance class 1



Model

- EN ISO 3650
- Special steel, hardened

Nominal size	Order no.	List price EUR
0.5	0624 100	27.00
1.0	0624 102	22.90
1.001	0624 104	22.90
1.002	0624 106	22.90
1.003	0624 108	22.90
1.004	0624 110	22.90
1.005	0624 112	22.90
1.006	0624 114	22.90
1.007	0624 116	22.90
1.008	0624 118	22.90
1.009	0624 120	22.90
1.01	0624 122	22.90
1.02	0624 130	22.90
1.03	0624 135	22.90
1.04	0624 140	22.90
1.05	0624 145	22.90
1.06	0624 150	22.90
1.07	0624 155	22.90
1.08	0624 160	22.90
1.09	0624 165	22.90
1.1	0624 170	22.90
1.11	0624 175	22.90
1.12	0624 180	22.90
1.13	0624 185	22.90
1.14	0624 190	22.90
1.15	0624 195	22.90
1.16	0624 200	22.90
1.17	0624 205	22.90
1.18	0624 210	22.90
1.19	0624 215	22.90
1.2	0624 220	22.90
1.21	0624 225	22.90
1.22	0624 230	22.90
1.23	0624 235	22.90
1.24	0624 240	22.90
1.25	0624 245	22.90
1.26	0624 250	22.90
1.27	0624 255	22.90
1.28	0624 260	22.90
1.29	0624 265	22.90

Nominal size	Order no.	List price EUR
1.30	0624 270	22.90
1.31	0624 275	22.90
1.32	0624 280	22.90
1.33	0624 285	22.90
1.34	0624 290	22.90
1.35	0624 295	22.90
1.36	0624 300	22.90
1.37	0624 305	22.90
1.38	0624 310	22.90
1.39	0624 315	22.90
1.40	0624 320	22.90
1.41	0624 325	22.90
1.42	0624 330	22.90
1.43	0624 335	22.90
1.44	0624 340	22.90
1.45	0624 345	22.90
1.46	0624 350	22.90
1.47	0624 355	22.90
1.48	0624 360	22.90
1.49	0624 365	22.90
1.50	0624 370	22.90
1.6	0624 375	22.90
1.7	0624 380	22.90
1.8	0624 385	22.90
1.9	0624 390	22.90
2.0	0624 395	22.90
2.5	0624 400	23.90
3.0	0624 405	23.90
3.5	0624 410	23.90
4.0	0624 415	23.90
4.5	0624 420	23.90
5.0	0624 425	23.90
5.5	0624 430	23.90
6.0	0624 435	23.90
6.5	0624 440	23.90
7.0	0624 445	23.90
7.5	0624 450	23.90
8.0	0624 455	23.90
8.5	0624 460	23.90
9.0	0624 465	23.90

Nominal size	Order no.	List price EUR
9.5	0624 470	23.90
10	0624 475	29.10
11	0624 500	29.10
12	0624 510	29.10
13	0624 520	29.10
14	0624 530	29.10
15	0624 540	29.10
16	0624 550	29.10
17	0624 560	29.10
18	0624 570	29.10
19	0624 580	29.10
20	0624 590	29.10
21	0624 600	29.10
22	0624 610	29.10
23	0624 620	29.10
24	0624 630	29.10
25	0624 640	29.10
30	0624 650	34.30
35	0624 660	34.30
40	0624 670	34.30
50	0624 680	34.30
60	0624 690	34.30
70	0624 700	34.30
80	0624 710	42.60
90	0624 720	42.60
100	0624 730	51.00
125	0624 740	165.00
150	0624 750	165.00
175	0624 760	165.00
200	0624 770	196.00
300	0624 780	281.00
400	0624 790	364.00
500	0624 800	504.00
600	0624 810	701.00
700	0624 820	727.00
800	0624 830	899.00
900	0624 840	1065.00
1000	0624 850	1320.00



0625 Individual steel gauge blocks, tolerance class 2



Model

- EN ISO 3650
- Special steel, hardened

Nominal size	Order no.	List price EUR
0.5	0625 100	21.80
1.0	0625 102	18.70
1.001	0625 104	18.70
1.002	0625 106	18.70
1.003	0625 108	18.70
1.004	0625 110	18.70
1.005	0625 112	18.70
1.006	0625 114	18.70
1.007	0625 116	18.70
1.008	0625 118	18.70
1.009	0625 120	18.70
1.01	0625 122	18.70
1.02	0625 130	18.70
1.03	0625 135	18.70
1.04	0625 140	18.70
1.05	0625 145	18.70
1.06	0625 150	18.70
1.07	0625 155	18.70
1.08	0625 160	18.70
1.09	0625 165	18.70
1.1	0625 170	18.70
1.11	0625 175	18.70
1.12	0625 180	18.70
1.13	0625 185	18.70
1.14	0625 190	18.70
1.15	0625 195	18.70
1.16	0625 200	18.70
1.17	0625 205	18.70
1.18	0625 210	18.70
1.19	0625 215	18.70
1.2	0625 220	18.70
1.21	0625 225	18.70
1.22	0625 230	18.70
1.23	0625 235	18.70
1.24	0625 240	18.70
1.25	0625 245	18.70
1.26	0625 250	18.70
1.27	0625 255	18.70
1.28	0625 260	18.70
1.29	0625 265	18.70

Nominal size	Order no.	List price EUR
1.30	0625 270	18.70
1.31	0625 275	18.70
1.32	0625 280	18.70
1.33	0625 285	18.70
1.34	0625 290	18.70
1.35	0625 295	18.70
1.36	0625 300	18.70
1.37	0625 305	18.70
1.38	0625 310	18.70
1.39	0625 315	18.70
1.40	0625 320	18.70
1.41	0625 325	18.70
1.42	0625 330	18.70
1.43	0625 335	18.70
1.44	0625 340	18.70
1.45	0625 345	18.70
1.46	0625 350	18.70
1.47	0625 355	18.70
1.48	0625 360	18.70
1.49	0625 365	18.70
1.50	0625 370	18.70
1.6	0625 375	18.70
1.7	0625 380	18.70
1.8	0625 385	18.70
1.9	0625 390	18.70
2.0	0625 395	18.70
2.5	0625 400	18.70
3.0	0625 405	18.70
3.5	0625 410	18.70
4.0	0625 415	18.70
4.5	0625 420	18.70
5.0	0625 425	18.70
5.5	0625 430	18.70
6.0	0625 435	18.70
6.5	0625 440	18.70
7.0	0625 445	18.70
7.5	0625 450	18.70
8.0	0625 455	18.70
8.5	0625 460	18.70
9.0	0625 465	18.70

Nominal size	Order no.	List price EUR
9.5	0625 470	18.70
10	0625 475	22.90
11	0625 500	22.90
12	0625 510	22.90
13	0625 520	22.90
14	0625 530	22.90
15	0625 540	22.90
16	0625 550	22.90
17	0625 560	22.90
18	0625 570	22.90
19	0625 580	22.90
20	0625 590	22.90
21	0625 600	22.90
22	0625 610	22.90
23	0625 620	22.90
24	0625 630	22.90
25	0625 640	22.90
30	0625 650	27.00
35	0625 660	27.00
40	0625 670	27.00
50	0625 680	27.00
60	0625 690	27.00
70	0625 700	27.00
80	0625 710	34.30
90	0625 720	34.30
100	0625 730	40.50
125	0625 740	132.00
150	0625 750	132.00
175	0625 760	132.00
200	0625 770	141.00
300	0625 780	223.00
400	0625 790	262.00
500	0625 800	343.00
600	0625 810	426.00
700	0625 820	509.00
800	0625 830	630.00
900	0625 840	746.00
1000	0625 850	924.00



0633 Gauge block accessories sets

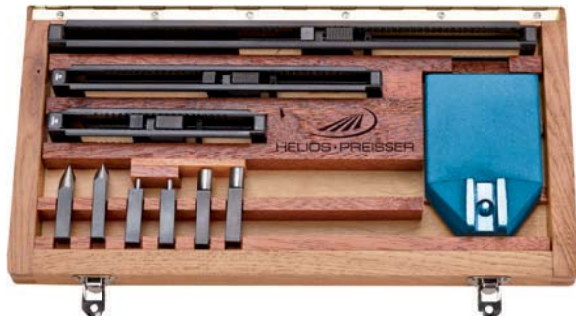

Delivery

- Wooden case

No. of parts	Gauge block holder (mm)						Radiused measuring jaw pairs (mm)						Scriber	Centre point	Plane parallel jaws (pair)	Knife edge jaws (pair)	Holder base	Order no.	List Price EUR
	0-50	0-100	100-200	0-300	200-400	300-500	4	10	16	20	30	40							
4				•		•							•					0633 130	1105.00
10	•	•	•				•	•					•	•			•	0633 131	1283.00
14	•	•	•				•	•	•	•			•	•			•	0633 132	1660.00
23	•	•	•	•	•		•	•	•	•	•		•	•	•		•	0633 133	3279.00

0633 Radiused measuring jaws with cylindrical shoulders / pair



☒	☒	Nominal size mm	Measuring depth mm	Order no.	List price EUR
		4	8	0633 150	205.00
		10	15	0633 151	205.00
		16	20	0633 152	220.00
		20	40	0633 153	270.00
		30	65	0633 154	380.00
		40	95	0633 155	495.00

0633 Inspection points, pair



Model

- Special steel, hardened

☒	☒	Base dimensions mm	Order no.	List price EUR
		55 x 9 x 9	0633 170	245.00



0633 Scribers



Model

- Special steel, hardened or carbide

☒	☒	Base dimensions mm	Order no.	List price EUR
Carbide				
		55 x 9 x 8	0633 172	360.00
Special steel				
		55 x 9 x 8	0633 171	89.00

0633 Centre point



Model

- Special steel, hardened

☒	☒	Base dimensions mm	Order no.	List price EUR
		55 x 9 x 12	0633 173	115.00

0633 Plane / parallel jaws, pair



Model

- For external measurement

☒	☒	Base dimensions mm	Order no.	List price EUR
For external measurements				
		100 x 9 x 20	0633 174	200.00
		125 x 9 x 20	0633 175	235.00
For internal and external measurements				
		100 x 9 x 20	0633 176	370.00
		125 x 9 x 20	0633 177	440.00

0633 Knife edge jaws, pair



Model

- Special steel, hardened

☒	☒	Base dimensions mm	Max diameter mm	Length mm	Order no.	List price EUR
		55 x 9 x 8	26	55	0633 178	215.00
		65 x 9 x 9	50	65	0633 179	270.00
		90 x 9 x 15	100	90	0633 180	325.00
		140 x 9 x 19	200	140	0633 181	485.00



0633 Gauge block holders with rapid adjustment



		Measuring range mm	Order no.	List price EUR
		0 - 50	0633 136	175.00
		0 - 100	0633 137	200.00
		0 - 200	0633 138	240.00
		100 - 200	0633 139	220.00
		100 - 300	0633 140	260.00
		200 - 400	0633 141	300.00
		300 - 500	0633 142	340.00
		400 - 600	0633 143	370.00
		500 - 800	0633 144	430.00
		800 - 1000	0633 145	600.00

0633 Stand for gauge block holder

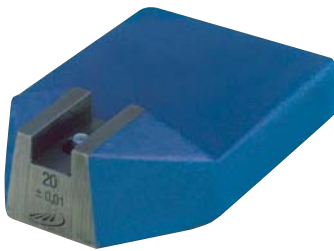

Model

- Special steel, hardened

		Base dimensions mm	Order no.	List price EUR
		103 x 70 x 27	0633 182	155.00

0633 Gauge block maintenance set



Model

- Set consists of:
- Linen cloth
 - Chamois leather
 - 1 jar of anti corrosion oil
 - Oil stone
 - Fine paint brush
 - Broad paint brush
 - User manual

Delivery

- Wooden case

		Order no.	List price EUR
		0633 001	301.00



0633 Steel gauge block inspection sets for micrometers



Model

- EN ISO 3650
- Special steel, hardened
- Tolerance class 1

Delivery

- Wooden case

»	¼	Max. nominal size mm	Order no.	List price EUR
5 pieces with optical flat				
		5.1 / 10.3 / 15.0 / 20.2 / 25.0	0633 805	325.00
8 pieces with optical flat				
		5.1 / 10.3 / 15.0 / 20.2 / 25.0 / 50.0 / 75.0 / 100	0633 808	435.00
10 pieces, excludes the optical flat				
		2.5 / 5.1 / 7.7 / 10.3 / 12.9 / 15.0 / 17.6 / 20.2 / 22.8 / 25.0	0633 810	264.00

0633 Steel gauge block inspection set for calipers

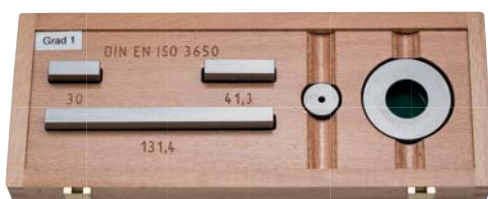

Model

- EN ISO 3650
- Special steel, hardened
- Tolerance class 1
- Supplied with setting rings 4 mm and 25 mm

Delivery

- Wooden case

»	¼	For measuring range mm	Max. nominal size mm	Order no.	List price EUR
3 pieces					
		200	30.0 / 41.3 / 131.4	0633 833	540.00
4 pieces					
		300	30.0 / 41.3 / 131.4 / 243.5	0633 834	721.00
6 pieces					
		500	30.0 / 41.3 / 131.4 / 243.5 / 281.2 / 481.1	0633 836	1287.00
5 pieces					
		1000	131.4 / 243.5 / 281.2 / 481.1 / 900	0633 838	2275.00



0633 Parallel steel gauge block sets



Model

- EN ISO 3650
- Special steel, hardened

Delivery

- Wooden case

▶	⚙	Number of devices	Tolerance class	Max. nominal size mm	Increment mm	Order no.	List price EUR
Tolerance class 0							
		103	0	1.005 1.01 - 1.49 0.5 - 24.5 25.0 - 100.0	- 0.01 0.5 25.0	0633 014	853.00
		87	0	1.001 - 1.009 1.01 - 1.49 0.5 - 9.5 10.0 - 100.0	0.001 0.01 0.5 10.0	0633 016	779.00
		47	0	1.005 1.01 - 1.09 1.11 - 1.19 1.1 - 1.9 1.0 - 9.0 10.0 - 100.0	- 0.01 0.01 0.1 1.0 10.0	0633 018	507.00
		32	0	1.005 1.01 - 1.09 1.1 - 1.9 1.0 - 9.0 10.0 - 30.0 50.0	- 0.01 0.1 1.0 10.0 -	0633 020	370.00
Tolerance class 1							
		103	1	1.005 1.01 - 1.49 0.5 - 24.5 25.0 - 100.0	- 0.01 0.5 25.0	0633 114	656.00
		87	1	1.001 - 1.009 1.01 - 1.49 0.5 - 9.5 10.0 - 100.0	0.001 0.01 0.5 10.0	0633 116	500.00
		47	1	1.005 1.01 - 1.09 1.11 - 1.19 1.1 - 1.9 1.0 - 9.0 10.0 - 100.0	- 0.01 0.01 0.1 1.0 10.0	0633 118	309.00
		32	1	1.005 1.01 - 1.09 1.1 - 1.9 1.0 - 9.0 10.0 - 30.0 50.0	- 0.01 0.1 1.0 10.0 -	0633 120	225.00



0633 Parallel steel gauge block sets



Model

- EN ISO 3650
- Special steel, hardened

Delivery

- Wooden case

»	¼	Number of devices	Tolerance class	Max. nominal size mm	Increment mm	Order no.	List price EUR
Tolerance class 2							
		103	2	1.005 1.01 - 1.49 0.5 - 24.5 25.0 - 100.0	- 0.01 0.5 25.0	0633 214	415.00
		87	2	1.001 - 1.009 1.01 - 1.49 0.5 - 9.5 10.0 - 100.0	0.001 0.01 0.5 10.0	0633 216	327.00
		47	2	1.005 1.01 - 1.09 1.11 - 1.19 1.1 - 1.9 1.0 - 9.0 10.0 - 100.0	- 0.01 0.01 0.1 1.0 10.0	0633 218	224.00
		32	2	1.005 1.01 - 1.09 1.1 - 1.9 1.0 - 9.0 10.0 - 30.0 50.0	- 0.01 0.1 1.0 10.0 -	0633 220	148.00



0634 Carbide gauge block sets



Model

- Carbide
- EN ISO 3650

Delivery

- Wooden case

✕	⊗	Number of devices	Tolerance class	Max. nominal size mm	Increment mm	Order no.	List price EUR
Tolerance class 0							
		103	0	1.005 1.01 - 1.49 0.5 - 24.5 25.0 - 100.0	- 0.01 0.5 25.0	0634 014	4389.00
		87	0	1.001 - 1.009 1.01 - 1.49 0.5 - 9.5 10.0 - 100.0	0.001 0.01 0.5 10.0	0634 016	3616.00
		47	0	1.005 1.01 - 1.09 1.11 - 1.19 1.1 - 1.9 1.0 - 9.0 10.0 - 100.0	- 0.01 0.01 0.1 1.0 10.0	0634 017	2363.00
		32	0	1.005 1.01 - 1.09 1.1 - 1.9 1.0 - 9.0 10.0 - 30.0 50.0	- 0.01 0.1 1.0 10.0 -	0634 020	1241.00
Tolerance class 1							
		103	1	1.005 1.01 - 1.49 0.5 - 24.5 25.0 - 100.0	- 0.01 0.5 25.0	0634 114	3863.00
		87	1	1.001 - 1.009 1.01 - 1.49 0.5 - 9.5 10.0 - 100.0	0.001 0.01 0.5 10.0	0634 116	3158.00
		47	1	1.005 1.01 - 1.09 1.11 - 1.19 1.1 - 1.9 1.0 - 9.0 10.0 - 100.0	- 0.01 0.01 0.1 1.0 10.0	0634 117	2117.00
		32	1	1.005 1.01 - 1.09 1.1 - 1.9 1.0 - 9.0 10.0 - 30.0 50.0	- 0.01 0.1 1.0 10.0 -	0634 120	1077.00



0634 Ceramic gauge block sets



Model

- Ceramic
- EN ISO 3650

Delivery

- Wooden case

※	¼	Number of devices	Tolerance class	Max. nominal size mm	Increment mm	Order no.	List price EUR
Tolerance class 0							
		103	0	1.005 1.01 - 1.49 0.5 - 24.5 25.0 - 100.0	- 0.01 0.5 25.0	0634 514	6128.00
		87	0	1.001 - 1.009 1.01 - 1.49 0.5 - 9.5 10.0 - 100.0	0.001 0.01 0.5 10.0	0634 516	4880.00
		47	0	1.005 1.01 - 1.09 1.11 - 1.19 1.1 - 1.9 1.0 - 9.0 10.0 - 100.0	- 0.01 0.01 0.1 1.0 10.0	0634 517	2910.00
		32	0	1.005 1.01 - 1.09 1.1 - 1.9 1.0 - 9.0 10.0 - 30.0 50.0	- 0.01 0.1 1.0 10.0 -	0634 520	1767.00
Tolerance class 1							
		103	1	1.005 1.01 - 1.49 0.5 - 24.5 25.0 - 100.0	- 0.01 0.5 25.0	0634 614	5130.00
		87	1	1.001 - 1.009 1.01 - 1.49 0.5 - 9.5 10.0 - 100.0	0.001 0.01 0.5 10.0	0634 616	4077.00
		47	1	1.005 1.01 - 1.09 1.11 - 1.19 1.1 - 1.9 1.0 - 9.0 10.0 - 100.0	- 0.01 0.01 0.1 1.0 10.0	0634 617	2432.00
		32	1	1.005 1.01 - 1.09 1.1 - 1.9 1.0 - 9.0 10.0 - 30.0 50.0	- 0.01 0.1 1.0 10.0 -	0634 620	1474.00



0636 Set of pin gauges



DIN
2269



Model

- Made out of high quality gauge steel

Delivery

- Wooden case

✕	⅔	Length mm	Number of pins	Tolerance class	Max. nominal size mm	Increment mm	Order no.	List price EUR
Special steel, hardened and aged								
		40	51	1	0.5 - 1.0	0.01	0636 301	779.00
		70	21	1	1.0 - 2.0	0.05	0636 321	236.00
		70	21	1	2.0 - 3.0	0.05	0636 322	236.00
		70	21	1	3.0 - 4.0	0.05	0636 323	292.00
		70	21	1	4.0 - 5.0	0.05	0636 324	292.00
		70	21	1	5.0 - 6.0	0.05	0636 325	292.00
		70	21	1	6.0 - 7.0	0.05	0636 326	356.00
		70	21	1	7.0 - 8.0	0.05	0636 327	356.00
		70	21	1	8.0 - 9.0	0.05	0636 328	356.00
		70	21	1	9.0 - 10.0	0.05	0636 329	356.00
		70	101	1	1.0 - 2.0	0.01	0636 341	992.00
		70	100	1	2.01 - 3.0	0.01	0636 342	992.00
		70	100	1	3.01 - 4.0	0.01	0636 343	1257.00
		70	100	1	4.01 - 5.0	0.01	0636 344	1257.00
		70	100	1	5.01 - 6.0	0.01	0636 345	1257.00
		70	100	1	6.01 - 7.0	0.01	0636 346	1547.00
		70	100	1	7.01 - 8.0	0.01	0636 347	1547.00
		70	100	1	8.01 - 9.0	0.01	0636 348	1547.00
		70	100	1	9.01 - 10.0	0.01	0636 349	1547.00
		70	91	1	1.0 - 10.0	0.1	0636 351	1268.00
		70	81	1	1.0 - 5.0	0.05	0636 352	1152.00
Special steel, hardened and aged								
		70	101	2	1.0 - 2.0	0.01	0636 372	694.00
		70	100	2	2.01 - 3.0	0.01	0636 373	694.00
		70	100	2	3.01 - 4.0	0.01	0636 374	914.00
		70	100	2	4.01 - 5.0	0.01	0636 375	914.00
		70	100	2	5.01 - 6.0	0.01	0636 376	914.00
		70	100	2	6.01 - 7.0	0.01	0636 377	1107.00
		70	100	2	7.01 - 8.0	0.01	0636 378	1255.00
		70	100	2	8.01 - 9.0	0.01	0636 379	1255.00
		70	100	2	9.01 - 10.0	0.01	0636 380	1255.00



0636 Pin gauge holder



Model

- Die cast
- With locking screw

⏏	📏	Measuring range mm	Length mm	Order no.	List price EUR
		1 - 2	60	0636 392	12.70
		2 - 4	68	0636 393	14.50
		4 - 6	76	0636 394	27.50
		6 - 8	84	0636 395	35.30
		8 - 10	92	0636 396	40.70



0637 Plug gauges



Model	⌘	%	Dimensions acc. DIN	Nominal size	Order no.	List price EUR	⌘	%	Dimensions acc. DIN	Nominal size	Order no.	List price EUR
				mm						mm		
<ul style="list-style-type: none"> Manufacturing tolerances: according to DIN 7150-2 and DIN 7164 Fit H7 All cylindrical Special dimensions with other tolerances are available upon request 			2245-1	2	0637 103	29.80			2245-1	34	0637 138	38.50
			2245-1	2.2	0637 104	29.80			2245-1	35	0637 139	38.50
			2245-1	2.5	0637 105	29.80			2245-1	36	0637 140	39.40
			2245-1	2.8	0637 106	21.70			2245-1	37	0637 141	40.20
			2245-1	3	0637 107	21.70			2245-1	38	0637 142	41.40
			2245-1	3.5	0637 108	19.40			2245-1	40	0637 144	42.60
			2245-1	4	0637 109	19.40			2245-2	42	0637 146	43.90
			2245-1	4.5	0637 110	19.40			2245-2	43	0637 147	54.00
			2245-1	5	0637 111	18.30			2245-2	44	0637 148	47.20
			2245-1	6	0637 112	18.30			2245-2	45	0637 149	48.20
			2245-1	7	0637 113	19.40			2245-2	46	0637 150	48.90
			2245-1	8	0637 114	19.40			2245-2	47	0637 151	51.00
			2245-1	9	0637 115	20.70			2245-2	48	0637 152	52.00
			2245-1	10	0637 116	21.70			2245-2	50	0637 154	54.00
			2245-1	11	0637 117	21.70			2245-2	52	0637 155	57.00
			2245-1	12	0637 118	23.00			2245-2	55	0637 156	60.00
			2245-1	13	0637 119	24.10			2245-2	58	0637 157	64.00
			2245-1	14	0637 120	24.10			2245-2	60	0637 158	66.00
			2245-1	15	0637 121	24.80			2245-2	62	0637 159	70.00
			2245-1	16	0637 122	24.80			2245-2	65	0637 160	70.00
			2245-1	17	0637 123	25.90			2245-2	68	0637 161	77.00
			2245-1	18	0637 124	26.90			2245-2	70	0637 162	78.00
			2245-1	19	0637 125	26.90			2245-2	72	0637 163	80.00
			2245-1	20	0637 126	26.90			2245-2	75	0637 164	84.00
			2245-1	21	0637 127	28.30			2245-2	78	0637 165	88.00
			2245-1	22	0637 128	28.90			2245-2	80	0637 166	89.00
			2245-1	23	0637 129	29.80			2245-2	82	0637 167	91.00
			2245-1	24	0637 130	29.80			2245-2	85	0637 168	95.00
			2245-1	25	0637 131	31.00			2245-2	88	0637 169	100.00
			2245-1	26	0637 132	32.20			2245-2	90	0637 170	101.00
			2245-1	27	0637 133	32.20			2245-2	92	0637 171	104.00
			2245-1	28	0637 134	33.20			2245-2	95	0637 172	106.00
			2245-1	30	0637 135	33.20			2245-2	98	0637 173	109.00
		2245-1	32	0637 136	36.80			2245-2	100	0637 174	111.00	
		2245-1	33	0637 137	37.40							

0637 Plug gauge set



Model

- DIN 2245
- Hardened gauge steel
- GO and NOGO

Delivery

- Wooden box

⌘	%	Set pcs	Tolerance class	Nominal size mm	Order no.	List price EUR
		(3, 4, 5, 6, 8, 10, 12)				
		7	H7	3 - 12 mm	0637 190	142.00



0643 Snap gauge, double jaw



Model

- Dimensions 3 to 100 mm
- Gauge steel
- Hardened measuring faces
- Dimensions acc. DIN 2230
- Manufacturing tolerances: according to DIN 7163

Delivery

- Available on request
- Important: Please mention dimension and fit

0649 Adjustable snap gauges



Model

- Special cast iron
- 1 fixed measuring face, 2 adjustable square measuring faces

Delivery

- Cardboard box

Max. nominal size mm	Order no.	List price EUR
0.000 - 6.000	0649 201	69.00
6.000 - 13.000	0649 202	69.00
13.000 - 19.000	0649 203	69.00
19.000 - 26.000	0649 204	71.00
26.000 - 32.000	0649 205	71.00
32.000 - 38.000	0649 206	75.00
38.000 - 44.000	0649 207	75.00
44.000 - 51.000	0649 208	78.00
51.000 - 57.000	0649 209	78.00
57.000 - 64.000	0649 210	82.00

Max. nominal size mm	Order no.	List price EUR
64.000 - 70.000	0649 211	82.00
70.000 - 78.000	0649 212	89.00
78.000 - 87.000	0649 213	89.00
87.000 - 97.000	0649 215	99.00
97.000 - 106.000	0649 216	113.00
106.000 - 116.000	0649 217	113.00
116.000 - 125.000	0649 219	135.00
125.000 - 135.000	0649 220	176.00
135.000 - 144.000	0649 222	202.00
144.000 - 156.000	0649 223	202.00



0650 Adjustable snap gauges



0650 103



0650 114

Model

- Adjustable
- Light alloy cast frame
- Carbide tipped measuring faces
- Without indicator
- Up to 100 mm with centering support and lift-off device. Snap gauges above 100 mm excludes centering support and lift-off device

Delivery

- Without digital indicator
- Cardboard box

▶	📏	Measuring range	Measuring surface	Order no.	List price
		mm	mm		EUR
		0 - 25	15 x 15	0650 101	877.00
		25 - 50	15 x 15	0650 102	958.00
		50 - 75	15 x 15	0650 103	1053.00
		75 - 100	15 x 15	0650 104	1153.00
		100 - 150	40 x 18	0650 105	1661.00
		150 - 200	40 x 18	0650 106	1880.00
		200 - 250	40 x 18	0650 107	2156.00
		250 - 300	40 x 18	0650 108	2245.00
		300 - 350	40 x 18	0650 109	2382.00
		350 - 400	40 x 18	0650 110	2578.00
		400 - 450	40 x 18	0650 111	2767.00
		450 - 500	40 x 18	0650 112	2957.00
		500 - 550	40 x 18	0650 113	3148.00
		550 - 600	40 x 18	0650 114	3402.00
		600 - 650	40 x 18	0650 115	4346.00
		650 - 700	40 x 18	0650 116	4533.00
		700 - 750	40 x 18	0650 117	4731.00
		750 - 800	40 x 18	0650 118	4924.00
		800 - 850	40 x 18	0650 119	5116.00



0656 Ring gauges



Model

- Hardened gauge steel
- DIN 2250-1 (C)
- For setting internal measuring instruments

DIN
2250-1

✕	📏	Nominal size	Order no.	List price	✕	📏	Nominal size	Order no.	List price
		mm		EUR			mm		EUR
		3	0656 309	55.00			58	0656 355	104.00
		3.5	0656 310	48.20			60	0656 356	108.00
		4	0656 311	48.20			62	0656 357	111.00
		4.5	0656 312	48.20			65	0656 358	118.00
		5	0656 313	47.20			68	0656 359	127.00
		6	0656 314	46.00			70	0656 360	131.00
		7	0656 315	46.00			72	0656 361	136.00
		8	0656 316	46.00			75	0656 362	140.00
		9	0656 317	46.00			78	0656 363	148.00
		10	0656 318	46.00			80	0656 364	153.00
		11	0656 319	47.20			82	0656 365	161.00
		12	0656 320	48.20			85	0656 366	172.00
		12.5	0656 303	48.20			88	0656 367	183.00
		17.5	0656 304	72.00			90	0656 368	189.00
		13	0656 321	48.90			92	0656 369	197.00
		14	0656 322	48.90			95	0656 370	210.00
		15	0656 323	50.00			98	0656 371	220.00
		16	0656 324	50.00			100	0656 372	227.00
		17	0656 325	51.00			105	0656 373	238.00
		18	0656 326	51.00			110	0656 374	250.00
		19	0656 327	52.00			115	0656 375	261.00
		20	0656 328	54.00			120	0656 376	273.00
		21	0656 329	54.00			125	0656 377	285.00
		22	0656 330	54.00			130	0656 378	295.00
		23	0656 331	57.00			135	0656 379	307.00
		24	0656 332	58.00			140	0656 380	318.00
		25	0656 333	59.00			145	0656 381	329.00
		26	0656 334	60.00			150	0656 382	341.00
		27	0656 335	60.00			155	0656 383	372.00
		28	0656 336	61.00			160	0656 384	402.00
		30	0656 337	57.00			165	0656 385	432.00
		32	0656 338	64.00			170	0656 386	464.00
		33	0656 339	64.00			175	0656 387	495.00
		34	0656 340	65.00			180	0656 388	525.00
		35	0656 341	65.00			185	0656 389	557.00
		36	0656 342	66.00			190	0656 390	586.00
		37	0656 343	68.00			195	0656 391	618.00
		38	0656 344	69.00			200	0656 392	648.00
		40	0656 345	70.00			210	0656 393	683.00
		42	0656 346	74.00			220	0656 394	713.00
		44	0656 347	78.00			225	0656 305	857.00
		45	0656 348	80.00			230	0656 395	747.00
		46	0656 349	82.00			240	0656 396	780.00
		47	0656 350	84.00			250	0656 397	814.00
		48	0656 351	86.00			260	0656 398	847.00
		50	0656 352	89.00			270	0656 399	879.00
		52	0656 353	91.00			275	0656 306	943.00
		55	0656 354	100.00					



0658 Thread plug gauges



**DIN
2280**

Model

- DIN 2280
- For standard metric ISO threads DIN 13
- Gauge steel, hardened

Fit	Type of thread	Nominal size mm	Thread pitch mm	Order no.	List price EUR
5H	M	1.0	0.25	0658 001	142.00
5H	M	1.2	0.25	0658 002	137.00
5H	M	1.4	0.30	0658 003	119.00
6H	M	1.6	0.35	0658 004	104.00
6H	M	1.8	0.35	0658 005	91.00
6H	M	2.0	0.40	0658 006	91.00
6H	M	2.2	0.45	0658 007	84.00
6H	M	2.5	0.45	0658 008	79.00
6H	M	3.0	0.5	0658 009	85.00
6H	M	3.5	0.6	0658 010	64.00
6H	M	4.0	0.7	0658 011	61.00
6H	M	5.0	0.8	0658 012	60.00
6H	M	6.0	1	0658 013	58.00
6H	M	7.0	1	0658 014	59.00
6H	M	8.0	1.25	0658 015	60.00
6H	M	9.0	1.25	0658 016	61.00
6H	M	10.0	1.5	0658 017	64.00
6H	M	11.0	1.5	0658 018	101.00
6H	M	12.0	1.75	0658 019	69.00
6H	M	14.0	2	0658 020	74.00
6H	M	16.0	2	0658 021	80.00
6H	M	18.0	2.5	0658 022	85.00
6H	M	20.0	2.5	0658 023	90.00
6H	M	22.0	2.5	0658 024	97.00
6H	M	24.0	3	0658 025	108.00
6H	M	27.0	3	0658 026	118.00
6H	M	30.0	3.5	0658 027	132.00
6H	M	33.0	3.5	0658 028	143.00
6H	M	36.0	4	0658 029	156.00
6H	M	39.0	4	0658 030	172.00
6H	M	42.0	4.5	0658 031	254.00
6H	M	45.0	4.5	0658 032	274.00
6H	M	48.0	5	0658 033	296.00
6H	M	52.0	5	0658 034	317.00
6H	M	56.0	5.5	0658 035	351.00
6H	M	60.0	5.5	0658 036	372.00
6H	M	64.0	6	0658 037	407.00
6H	M	68.0	6	0658 038	433.00

0658 Set of thread plug gauges



Delivery

- Wooden box

**DIN
2280**

Tolerance class	Type of thread	Nominal size mm	Order no.	List price EUR
(M3, M4, M5, M6, M8, M10, M12)				
6H	M	M3 - M12	0658 090	242.00



0658 GO thread ring gauges



Model

- GO thread ring gauge
- For standard metric ISO threads DIN 13
- Hardened gauge steel
- DIN 2285-1

DIN
2285-1

⌘	📐	Fit	Type of thread	Nominal size	Thread pitch	Order no.	List price
				mm	mm		EUR
		6h	M	1.0	0.25	0658 501	143.00
		6h	M	1.2	0.25	0658 502	136.00
		6h	M	1.4	0.30	0658 503	126.00
		6g	M	1.6	0.35	0658 504	91.00
		6g	M	1.8	0.35	0658 505	83.00
		6g	M	2.0	0.40	0658 506	83.00
		6g	M	2.2	0.45	0658 507	72.00
		6g	M	2.5	0.45	0658 508	62.00
		6g	M	3.0	0.50	0658 509	51.00
		6g	M	3.5	0.60	0658 510	48.20
		6g	M	4.0	0.70	0658 511	47.20
		6g	M	5.0	0.8	0658 512	47.20
		6g	M	6.0	1.0	0658 513	47.20
		6g	M	7.0	1.0	0658 514	47.20
		6g	M	8.0	1.25	0658 515	48.20
		6g	M	9.0	1.25	0658 516	51.00
		6g	M	10.0	1.5	0658 517	57.00
		6g	M	11.0	1.5	0658 518	64.00
		6g	M	12.0	1.75	0658 519	66.00
		6g	M	14.0	2	0658 520	72.00
		6g	M	16.0	2	0658 521	80.00
		6g	M	18.0	2.5	0658 522	91.00
		6g	M	20.0	2.5	0658 523	102.00
		6g	M	22.0	2.5	0658 524	110.00
		6g	M	24.0	3	0658 525	118.00
		6g	M	27.0	3	0658 526	133.00
		6g	M	30.0	3.5	0658 527	143.00
		6g	M	33.0	3.5	0658 528	158.00
		6g	M	36.0	4	0658 529	169.00
		6g	M	39.0	4	0658 530	184.00
		6g	M	42.0	4.5	0658 531	201.00
		6g	M	45.0	4.5	0658 532	212.00
		6g	M	48.0	5	0658 533	224.00
		6g	M	52.0	5	0658 534	243.00
		6g	M	56.0	5.5	0658 535	257.00
		6g	M	60.0	5.5	0658 536	274.00
		6g	M	64.0	6	0658 537	294.00
		6g	M	68.0	6	0658 538	311.00



0658 NO GO thread ring gauges



DIN
2299-1



Model

- NOGO thread ring gauge
- For standard metric ISO threads DIN 13
- Hardened gauge steel
- DIN 2299-1

⌘	⚙	Fit	Type of thread	Nominal size mm	Thread pitch	Order no.	List price EUR
		6h	M	1.0	0.25	0658 601	143.00
		6h	M	1.2	0.25	0658 602	136.00
		6h	M	1.4	0.30	0658 603	126.00
		6h	M	1.6	0.35	0658 604	91.00
		6h	M	1.8	0.35	0658 605	83.00
		6h	M	2.0	0.40	0658 606	83.00
		6g	M	2.2	0.45	0658 607	72.00
		6g	M	2.5	0.45	0658 608	62.00
		6g	M	3.0	0.50	0658 609	51.00
		6g	M	3.5	0.60	0658 610	48.20
		6g	M	4.0	0.70	0658 611	47.20
		6g	M	5.0	0.8	0658 612	47.20
		6g	M	6.0	1.0	0658 613	47.20
		6g	M	7.0	1.0	0658 614	47.20
		6g	M	8.0	1.25	0658 615	48.20
		6g	M	9.0	1.25	0658 616	51.00
		6g	M	10.0	1.5	0658 617	57.00
		6g	M	11.0	1.5	0658 618	65.00
		6g	M	12.0	1.75	0658 619	66.00
		6g	M	14.0	2	0658 620	72.00
		6g	M	16.0	2	0658 621	80.00
		6g	M	18.0	2.5	0658 622	91.00
		6g	M	20.0	2.5	0658 623	102.00
		6g	M	22.0	2.5	0658 624	110.00
		6g	M	24.0	3	0658 625	118.00
		6g	M	27.0	3	0658 626	133.00
		6g	M	30.0	3.5	0658 627	143.00
		6g	M	33.0	3.5	0658 628	158.00
		6g	M	36.0	4	0658 629	169.00
		6g	M	39.0	4	0658 630	184.00
		6g	M	42.0	4.5	0658 631	201.00
		6g	M	45.0	4.5	0658 632	212.00
		6g	M	48.0	5	0658 633	224.00
		6g	M	52.0	5	0658 634	243.00
		6g	M	56.0	5.5	0658 635	257.00
		6g	M	60.0	5.5	0658 636	274.00
		6g	M	64.0	6	0658 637	294.00
		6g	M	68.0	6	0658 638	311.00



0658 Thread ring gauges GO

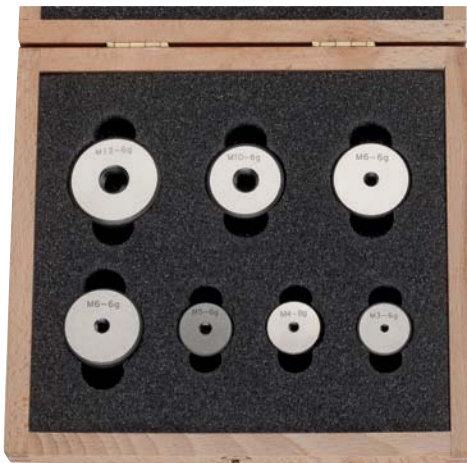

Model

- 7-pieces
- Hardened gauge steel
- For standard metric ISO threads
DIN 13
- Fit 6g

Delivery

- Wooden case

DIN
2285-1

		Fit	Type of thread	Nominal size mm	Order no.	List price EUR
(M3. M4. M5. M6. M8. M10. M12)						
		6g	M	3 - 12	0658 590	242.00

0658 Thread ring gauges NO GO

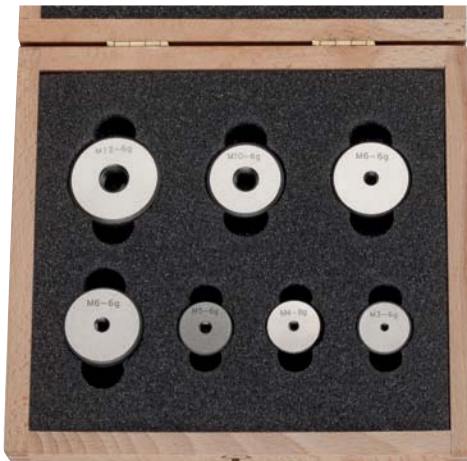

Model

- 7-pieces
- Hardened gauge steel
- For standard metric ISO threads
DIN 13
- Fit 6g

Delivery

- Wooden case

DIN
2299-1

		Fit	Type of thread	Nominal size mm	Order no.	List price EUR
(M3. M4. M5. M6. M8. M10. M12)						
		6g	M	3 - 12	0658 690	242.00

SAMPLES DATA TRANSMISSION

NEW



**integrated
IW wireless**

**NO CABLE
NO RADIO MODULE**

Thanks to the integrated wireless system our measuring devices from series **i** offer simple data transmission without additional cables

Transmission of data directly to MS Excel[®] or into any application on Windows via keyboard interface

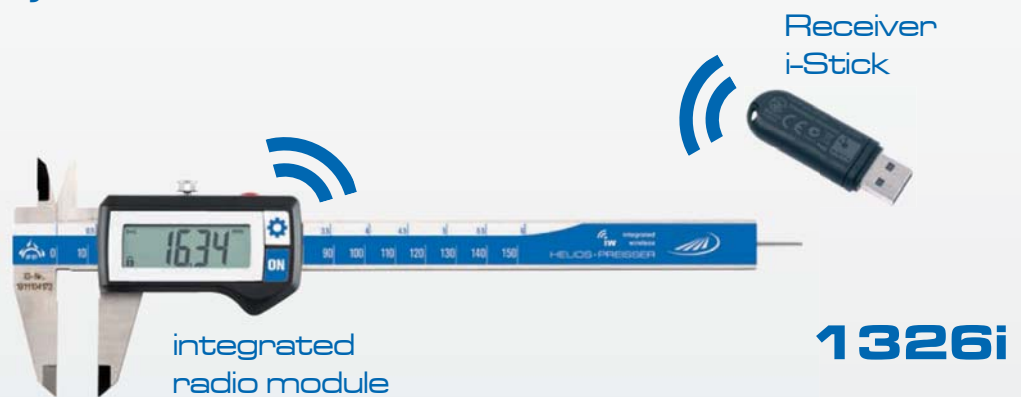

DATA Variable

**ONE INTERFACE
MANY OPTIONS**



OUT **STANDARD** FOR
DATA TRANSMISSION
WITH CABLES

USB + RS 232 + DIGIMATIC

7. CHAPTER DATA TRANSMISSION

278	Data cables Data Variable / Software
279	Integrated Wireless
280	Data cables Opto / BlueDat
281	USB-keyboard interface



1998 / 1997 Data cable DATA VARIABLE



Our Interface: Data Variable



DATA-Button
To transfer the measured results

Possible connections



USB

RS 232

Digimatic

Model

- Available for all DIGI-MET measuring instruments with a variable data output (DATA VARIABLE)
- Length 2 m
- With a data transfer button on the plug-in jack
- For use with MarCom Professional software to transfer the measured results to PC, laptop or workstation

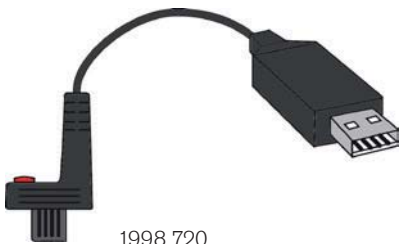

1998 720



1997 501

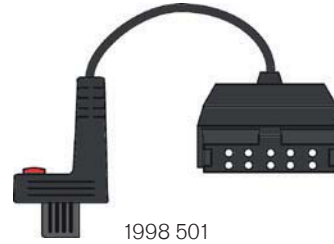

1998 501

	Description	Order no.	List price EUR
	Cable DataVariable for RS 232	1997 501	48.00
	Cable DataVariable for Digimatic	1998 501	61.00
	Cable DataVariable for USB	1998 720	69.00

1998 Software MarCom Professional



Model

Software for easy data acquisition, for all measuring instruments with variable data output (DATA VARIABLE) and integrated wireless (IW)

- Connection to more than 100 measuring instruments with USB data cable possible
- Data transmission with virtual interface box MUX 50 format possible
- Connection of two serial COM-interfaces possible
- Several foot switches via USB connectable, the measuring instruments can be freely assigned
- USB Hubs connectable as measuring instrument interface
- Wireless data transfer with Integrated Wireless (IW) devices
- Wireless data transfer via **blueDAT**

System requirements

IBM AT compatible PC, MS Windows 7 / 8 / 10, USB-interface from version 2.0 MS EXCEL® from version 97

DOWNLOAD FOR FREE
www.helios-preisser.de

	Description	Order no.
	MarCom Professional	1998 710



1998 i-Stick USB-receiver for Integrated Wireless

NOVELTY
Data transmission without cable
or radio module

iW integrated wireless



Model

- **Measurement without the nuisance of additional modules:** Unlike conventional wireless solutions, which have a large external transmitter with separate battery, the transmitter in Integrated Wireless is fully integrated.
- **Highly mobile:** Integrated Wireless gives you much more mobility. There is no cable to get in the way, either at the measuring station or when measuring on or at the machine or at large workpieces
- **Easy data transfer:** With Integrated Wireless you can transfer your measured values to the PC simply using the i-Stick. As with a data cable, the measured values are accepted via the MarCom software directly into MS Excel© or via a keyboard code into any Windows application
- **Reliable transfer:** With Integrated Wireless you can be sure that your data will arrive safely. Measuring instruments with Integrated Wireless display messages to confirm whether the transmitted data has been correctly transferred or whether you are within receiving range of the i-Stick receiver
- **Long battery life:** The integrated wireless interface makes the measuring instrument exceptionally energy-efficient. And unlike conventional wireless systems, no additional battery is required
- **Affordable:** With Integrated Wireless you can connect up to 8 measuring instruments per i-Stick receiver. Expensive interface boxes are no longer necessary. With even one connected measuring instrument you get a wireless connection for the price of a cable

7

⏪ ⏩	Number of channels	Frequency band MHz	Radio range	Number of i-Sticks per workspace	Number of devices max.	For measuring instruments	Order no.	List price Euro EUR
	3	2400	up to 6 meters	4	32 (8 per i-Stick)	1326i / 1371i / 1726i / 1734i	1998 780	97.00



1998 Accesories for data aquisition with MarCom



Example: possible measuring station setup

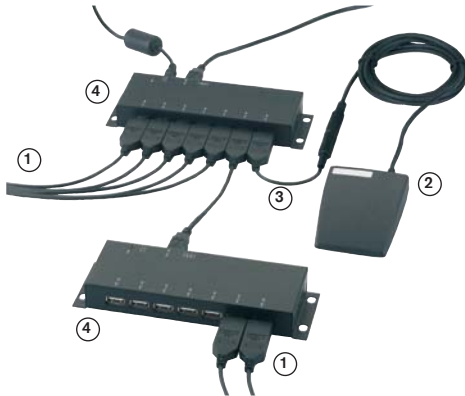

Model

1. USB-cable to devices
2. Foot switch with jack plug
3. USB-adapter-cable for foot switch
4. USB-hub for connecting several devices

⌘	⌘	Description	Order no.	List price EUR
		Cable DataVariable for USB	1998 720	69.00
		USB-adapter cable for foot switch	1998 722	58.00
		USB-hub sevenfold with plug-in power supply	1998 730	115.00
		Foot-switch* (length of the cable 2 m)	1998 732	69.00

* To connect to the MarCom, the USB-adapter cable Ref. No. 1998 722 is required

0996 Data cable opto RS232



⌘	⌘	Description	Order no.	List price EUR
		Cable Opto for RS232	0996 701	74.00
		Cable Opto for USB	0996 705	141.00

1998 blueDAT - wireless data transmission (bluetooth)



Model

Available for all DIGI-MET measuring instruments with a variable data output (DATA VARIABLE)

- Reach: approx. 10 m
- With a data transfer button on the plug-in jack

- USB receiver for use with MarCom Professional software to transfer the measured results to PC, laptop or workstation

⌘	⌘	Description	Order no.	List price EUR
		blueDAT USB receiver	1998 740	97.00
		blueDAT for DATA Variable	1998 742	348.00
		blueDAT for RS 232 opto	1998 744	348.00
		blueDAT for RS 232 Proximity	1998 746	477.00
		blueDAT for RS 232 Power (Powered through cable)	1998 748	477.00



0997 USB-keyboard interface cable



(Menu) button



0997 770



0997 772



0997 774

Model

- USB-keyboard interface and data cable are in one unit (length of the cable: 2 m)
- For connection of one unit
- Power supply via USB-Interface
- No driver file for the USB-Interface required
- The USB-Interface reveal themselves as a keyboard
- Terminators like Enter or Tab can be adjusted in the USB-Interface
- More settings such as language, separator and timer
- Transmit data using either the data-switch on measuring instrument or with a timer

	Description	Order no.	List price EUR
	USB-keyboard interface cable Opto RS 232	0997 770	241.00
	USB-keyboard interface RS 232 Proximity	0997 772	241.00
	USB-keyboard interface cable RS 232 Power (Power supply through data cable)	0997 774	294.00

0997 USB-keyboard interface „T-Box 302 USB“



4 RS 232 input ports



Connection for foot switch

Model

- USB-keyboard interface for 4 x RS 232C input
- for simultaneous connection of up to 4 devices
- power supply via USB-port
- no driver file for the USB-Interface required
- the USB-Interface reveal themselves as a keyboard
- terminators like Enter or Tab can be adjusted in the USB-Interface
- more settings such as language, separator and timer
- measured results can be directly conveyed e.g. to EXCEL or other text processing or statistics programs.
- foot switch connector, transmit data on measuring instrument or cable for data transmission or with a timer

	Description	Order no.	List price EUR
	Keyboard interface T-Box 302 USB	0997 778	791.00



CALIBRATIONS

Traceable calibration certificates
directly from the **expert**

Certificates are already **included**
for **selected products**

We are certified according to
DIN EN ISO 9001:2015



8. CHAPTER CALIBRATION SERVICE ORDER NUMBER INDEX AND KEYWORD INDEX

284 Calibration service

286 Order number index

302 Keyword index





Free initial calibration available with many of our products





All HELIOS-PREISSER measuring instruments with a  marked in the column (=Calibration), will undergo initial calibration and are supplied with a certificate at no extra charge! No separate order is required for these articles to be pre-calibrated on delivery. For all other gauges and measuring instruments, and for subsequent calibration, the following calibration services are offered. Testing is carried out in accordance with VDI / VDE / DGQ guidelines 26 ff.

Calibration service





Calipers / Depth gauges / Height gauges analogue or digital (1 graduation)

		max. measuring range mm	Order no.	List price EUR
		150	4310 110	11.50
		300	4310 115	20.60
		500	4310 120	34.80
		1000	4310 125	74.00
		2000	4310 130	102.00
		3000	4310 135	159.00

Micrometers according to DIN 863-1

		max. measuring range mm	Order no.	List price EUR
		25	4320 210	19.60
		100	4320 212	26.40
		200	4320 214	28.70
		300	4320 220	31.80
		500	4320 224	35.10
		1000	4320 228	58.00



Micrometers with interchangeable inserts including setting standard

		max. measuring range mm	Order no.	List price EUR
		100	4320 810	123.00
		200	4320 814	175.00
		300	4320 818	187.00
		400	4320 822	192.00
		500	4320 826	192.00
		600	4320 830	192.00
		700	4320 834	245.00
		800	4320 838	245.00
		900	4320 842	245.00
		1000	4320 846	245.00
		1200	4320 850	291.00
		1400	4320 854	291.00
		1600	4320 858	347.00
		1800	4320 862	347.00
		2000	4320 866	347.00

Setting standards for micrometers Tolerance zone js2

		max. measuring range mm	Order no.	List price EUR
		100	4329 010	7.00
		500	4329 026	16.00
		1000	4329 046	32.00

Squares with and without base, knife edge squares according to DIN 875 all accuracies

		max. length mm	Order no.	List price EUR
		100	4340 210	15.00
		200	4340 214	16.50
		500	4340 218	24.30
		750	4340 222	41.60
		1000	4340 226	49.60
		1500	4340 230	74.00



Protractor

		Order no.	List price EUR
		4342 410	11.50

Universal bevel protractor analogue or digital (1 blade)

		Order no.	List price EUR
		4342 610	26.40

Rules according to DIN 866 Form A / B

		max. length mm	Order no.	List price EUR
		500	4350 210	30.10
		1000	4350 218	49.20
		1500	4350 226	74.00
		2000	4350 232	96.00
		3000	4350 238	134.00



Calibration service



Flat rules according to DIN 874 Part 1 all accuracies

	max. length mm	Order no.	List price EUR
	500	4351 610	25.10
	1000	4351 618	59.00
	2000	4351 628	87.00
	3000	4351 638	111.00

Knife edge rules according to DIN 874 Part 2 all accuracies

	max. length mm	Order no.	List price EUR
	200	4352 412	14.30
	500	4352 418	22.70
	1000	4352 422	43.00

Levels

	max. length mm	Order no.	List price EUR
	300	4353 410	52.00

Frame levels

	max. length mm	Order no.	List price EUR
	300	4353 510	73.00

Parallel gauge blocks

	max. nominal size	Order no.	List price EUR
	100	4357 010	10.80
	300	4357 020	31.80

Plug gauges. GO / NOGO master gauges

	max. diameter mm	Order no.	List price EUR
	100	4357 610	11.00
	200	4357 620	18.70

Setting rings (master rings)

	max. diameter mm	Order no.	List price EUR
	100	4358 410	16.50
	200	4358 420	29.10

Snap gauges. GO and NOGO

	max. nominal size	Order no.	List price EUR
	100	4358 810	18.70

Thread plug gauges. GO / NOGO thread gauges

	max. diameter mm	Order no.	List price EUR
	100	4359 210	23.80

Thread master rings

	max. diameter mm	Order no.	List price EUR
	100	4359 410	30.40

Indicators. analogue and digital. readings/resolution 0.01 and 0.001

	max. measuring range mm	Order no.	List price EUR
	13	4360 210	24.30
	30	4360 212	34.80
	50	4360 214	39.50
	100	4360 218	51.00

Dial test indicator

	Order no.	List price EUR
	4360 810	33.70



Ref. No.	Page	List price €	Ref. No.	Page	List price €	Ref. No.	Page	List price €
0003219	83	7.40	0203501	18	49.50	0235524	39	1,613.00
0003220	83	8.80	0212520	22	128.00	0235526	39	2,376.00
0003221	83	11.10	0212522	22	187.00	0236201	40	90.00
0003222	83	15.40	0212524	22	187.00	0236202	40	110.00
0003223	83	17.20	0212526	22	213.00	0236203	40	124.00
0003224	83	25.90	0212528	22	213.00	0236204	42	230.00
0003225	83	33.70	0216521	21	352.00	0236205	40	254.00
0003226	83	40.20	0217501	21	65.00	0236206	42	327.00
0003227	83	36.80	0217502	21	131.00	0236207	42	399.00
0003228	83	44.80	0218501	21	87.00	0236208	40	335.00
0003229	83	46.00	0219503	44	288.00	0236209	42	444.00
0003230	83	47.20	0220204	93	3.20	0236210	42	535.00
0003231	83	48.20	0220704	24	3.70	0236211	40	401.00
0003232	83	48.20	0220705	26	21.50	0236212	42	557.00
0003233	83	58.00	0222734	50	2,569.00	0236213	42	685.00
0003234	83	64.00	0222736	50	3,083.00	0236214	40	428.00
0003235	83	70.00	0223734	50	2,741.00	0236215	42	644.00
0003236	83	59.00	0223736	50	3,176.00	0236216	42	824.00
0003237	83	63.00	0224734	51	2,323.00	0236217	42	957.00
0003238	83	64.00	0224736	51	2,816.00	0236218	40	535.00
0003239	83	72.00	0225734	51	2,449.00	0236219	42	791.00
0003240	83	83.00	0225736	51	2,907.00	0236220	42	883.00
0003241	83	83.00	0228701	54	473.00	0236221	42	1,331.00
0003242	83	79.00	0228702	54	658.00	0236222	40	828.00
0003243	83	84.00	0228703	54	925.00	0236224	40	1,129.00
0003244	83	95.00	0228704	54	1,091.00	0236225	42	1,365.00
0003245	83	105.00	0228724	54	2,753.00	0236226	40	1,556.00
0003246	83	113.00	0228726	54	3,273.00	0236227	42	1,899.00
0003247	83	130.00	0230501	37	140.00	0236230	40	2,574.00
0003248	83	110.00	0230502	37	156.00	0236231	42	3,139.00
0003249	83	110.00	0230503	37	171.00	0236501	40	103.00
0003250	83	140.00	0230508	37	489.00	0236502	40	130.00
0003251	83	146.00	0231501	37	166.00	0236503	40	140.00
0003252	83	158.00	0231502	37	182.00	0236504	42	248.00
0003253	83	188.00	0231503	37	197.00	0236505	40	297.00
0003254	83	245.00	0231508	37	535.00	0236506	42	381.00
0003255	83	289.00	0234201	38	105.00	0236507	42	463.00
0003256	83	273.00	0234202	38	128.00	0236508	40	391.00
0003257	83	294.00	0234203	38	137.00	0236509	42	514.00
0003258	83	305.00	0234205	38	321.00	0236510	42	614.00
0003259	83	353.00	0234208	38	402.00	0236511	40	467.00
0003280	212	4.10	0234211	38	470.00	0236512	42	581.00
0003281	212	4.50	0234214	38	535.00	0236513	42	756.00
0003282	212	4.70	0234218	38	649.00	0236514	40	484.00
0003283	212	5.90	0234222	38	1,038.00	0236515	42	748.00
0003284	212	6.50	0234224	38	1,342.00	0236516	42	954.00
0003285	212	7.40	0234226	38	1,960.00	0236517	42	1,119.00
0003286	212	8.60	0234501	38	124.00	0236518	40	604.00
0003287	212	8.20	0234502	38	143.00	0236519	42	917.00
0003288	212	18.50	0234503	38	157.00	0236520	42	1,157.00
0003289	212	11.10	0234505	38	364.00	0236521	42	1,581.00
0003290	212	18.50	0234508	38	469.00	0236522	40	992.00
0003291	212	32.00	0234511	38	532.00	0236524	40	1,331.00
0003292	212	35.30	0234514	38	603.00	0236525	42	1,624.00
0003293	212	35.60	0234518	38	724.00	0236526	40	2,006.00
0003294	212	39.80	0234522	38	1,182.00	0236527	42	2,405.00
0145110	28	164.00	0234524	38	1,521.00	0237201	41	116.00
0180310	20	4.20	0234526	38	2,227.00	0237202	41	137.00
0180320	20	6.80	0235201	39	132.00	0237203	41	150.00
0180330	20	6.80	0235202	39	153.00	0237204	43	255.00
0182501	19	33.20	0235203	39	161.00	0237205	41	304.00
0184501	14	25.00	0235205	39	371.00	0237206	43	377.00
0184505	14	33.00	0235208	39	452.00	0237207	43	450.00
0184508	14	49.00	0235211	39	518.00	0237208	41	387.00
0185500	14	19.50	0235214	39	594.00	0237209	43	496.00
0185501	14	25.00	0235218	39	692.00	0237210	43	585.00
0185505	14	33.00	0235222	39	1,136.00	0237211	41	452.00
0185508	14	49.00	0235224	39	1,435.00	0237212	43	605.00
0188501	15	22.00	0235226	39	2,119.00	0237213	43	736.00
0189501	15	22.00	0235501	39	141.00	0237214	41	487.00
0190501	18	26.00	0235502	39	169.00	0237215	43	707.00
0194501	15	26.00	0235503	39	181.00	0237216	43	885.00
0195501	15	26.00	0235505	39	412.00	0237217	43	1,019.00
0197501	17	32.00	0235508	39	507.00	0237218	41	594.00
0197505	17	75.00	0235511	39	577.00	0237219	43	854.00
0197508	17	149.00	0235514	39	664.00	0237220	43	945.00
0198501	17	29.50	0235518	39	784.00	0237221	43	1,392.00
0199501	17	29.50	0235522	39	1,268.00	0237222	41	922.00



Ref. No.	Page	List price €	Ref. No.	Page	List price €	Ref. No.	Page	List price €
0237224	41	1,224.00	0250571	58	277.00	0286206	67	126.00
0237225	43	1,460.00	0250572	58	772.00	0286207	67	160.00
0237226	41	1,710.00	0250573	58	918.00	0286208	67	268.00
0237227	43	2,052.00	0250574	58	1,155.00	0286209	67	420.00
0237230	41	2,797.00	0250575	58	1,403.00	0286210	67	583.00
0237231	43	3,361.00	0252201	60	137.00	0286212	67	1,259.00
0237501	41	127.00	0252202	60	264.00	0286213	67	1,623.00
0237502	41	155.00	0252203	60	289.00	0286501	67	89.00
0237503	41	167.00	0252291	60	4.20	0286502	67	90.00
0237504	43	272.00	0252293	60	5.20	0286504	67	104.00
0237505	41	347.00	0253300	60	81.00	0286505	67	110.00
0237506	43	430.00	0253301	60	81.00	0286507	67	177.00
0237507	43	512.00	0253302	60	103.00	0286508	67	372.00
0237508	41	439.00	0253391	60	3.70	0286509	67	502.00
0237509	43	562.00	0258501	61	138.00	0286510	67	639.00
0237510	43	663.00	0258502	61	184.00	0292501	68	84.00
0237511	41	514.00	0258503	61	283.00	0292502	68	96.00
0237512	43	676.00	0258504	61	320.00	0294504	68	451.00
0237513	43	807.00	0258505	61	357.00	0294505	68	720.00
0237514	41	544.00	0260501	62	71.00	0294506	68	1,119.00
0237515	43	809.00	0260502	62	71.00	0294507	68	1,517.00
0237516	43	1,012.00	0261516	19	215.00	0300007	180	2.00
0237517	43	1,181.00	0262503	59	260.00	0300008	180	2.20
0237518	41	665.00	0268201	64	296.00	0300009	180	1.00
0237519	43	975.00	0268211	64	361.00	0300010	180	1.00
0237520	43	1,218.00	0268518	62	175.00	0300011	180	2.00
0237521	43	1,644.00	0268522	62	187.00	0300013	180	9.80
0237522	41	1,083.00	0273731	82	197.00	0300014	180	3.40
0237524	41	1,424.00	0273732	82	203.00	0300102	180	5.40
0237525	43	1,720.00	0273735	82	220.00	0300103	180	9.90
0237526	41	2,158.00	0273738	82	233.00	0300112	180	4.50
0237527	43	2,556.00	0273741	82	283.00	0300114	180	8.40
0238503	44	364.00	0273745	82	495.00	0300120	180	12.30
0238508	44	520.00	0273746	82	539.00	0300130	180	3.30
0238514	44	695.00	0273751	82	353.00	0301001	181	7.00
0238518	44	814.00	0273752	82	358.00	0301002	181	8.00
0238524	44	2,110.00	0273755	82	380.00	0301003	181	8.80
0238526	44	2,457.00	0273758	82	400.00	0301004	181	12.30
0250101	58	5.70	0273761	82	430.00	0301005	181	14.90
0250102	58	11.40	0273765	82	604.00	0301006	181	40.20
0250103	58	15.60	0273766	82	649.00	0301007	181	57.00
0250201	58	57.00	0276711	71	6.10	0301008	181	75.00
0250202	58	82.00	0279722	73 / 78	261.00	0301009	181	105.00
0250501	57	245.00	0279723	73 / 78	273.00	0301010	181	154.00
0250502	57	667.00	0280501	65	59.00	0302001	181	10.30
0250503	57	998.00	0281201	65	78.00	0302002	181	11.30
0250504	57	1,213.00	0281202	65	81.00	0302003	181	12.10
0250505	57	1,213.00	0281204	65	90.00	0302004	181	15.80
0250511	57	264.00	0281205	65	102.00	0302005	181	20.70
0250512	57	700.00	0281501	65	85.00	0302006	181	58.00
0250513	57	832.00	0281502	65	88.00	0302007	181	71.00
0250514	57	1,070.00	0281504	65	101.00	0302008	181	91.00
0250515	57	1,300.00	0281505	65	110.00	0302009	181	127.00
0250521	57	264.00	0282201	66	69.00	0302010	181	176.00
0250522	57	700.00	0282202	66	71.00	0303001	186	6.80
0250523	57	832.00	0282203	66	82.00	0303002	186	7.40
0250524	57	1,070.00	0282204	66	79.00	0303003	186	8.40
0250525	57	1,300.00	0282205	66	86.00	0303004	186	9.00
0250531	57	264.00	0282206	66	97.00	0303005	186	10.30
0250532	57	700.00	0282207	66	133.00	0303006	186	12.60
0250533	57	832.00	0282208	66	205.00	0303007	186	15.60
0250534	57	1,070.00	0282209	66	338.00	0303008	186	23.60
0250535	57	1,300.00	0282210	66	480.00	0303009	186	34.00
0250541	57	264.00	0282212	66	1,172.00	0303010	186	62.00
0250542	57	700.00	0282213	66	1,540.00	0303012	186	545.00
0250543	57	832.00	0282501	66	75.00	0303015	186	579.00
0250544	58	1,070.00	0282502	66	79.00	0303020	186	617.00
0250545	58	1,300.00	0282503	66	89.00	0304001	186	6.80
0250551	58	264.00	0282504	66	86.00	0304002	186	7.40
0250552	58	700.00	0282505	66	95.00	0304003	186	8.40
0250553	58	832.00	0282507	66	146.00	0304004	186	9.00
0250554	58	1,070.00	0282508	66	223.00	0304005	186	10.30
0250555	58	1,300.00	0282509	66	371.00	0304006	186	12.60
0250561	58	264.00	0282510	66	526.00	0304007	186	15.60
0250562	58	700.00	0286201	67	82.00	0304008	186	23.60
0250563	58	832.00	0286202	67	84.00	0304009	186	34.00
0250564	58	1,070.00	0286204	67	95.00	0304010	186	62.00
0250565	58	1,300.00	0286205	67	102.00	0304012	186	545.00



Ref. No.	Page	List price €	Ref. No.	Page	List price €	Ref. No.	Page	List price €
0304015	186	579.00	0319510	191	38.40	0369107	198	40.80
0304020	186	617.00	0320001	191	44.20	0369108	198	100.00
0306001	181	13.10	0320002	191	85.00	0369109	198	123.00
0306003	181	14.90	0320101	191	69.00	0369110	198	243.00
0306005	181	23.20	0320102	191	108.00	0369111	198	451.00
0308201	185	90.00	0321301	189	21.80	0369112	198	804.00
0308202	185	108.00	0321302	189	24.40	0369202	198	16.70
0308303	185	132.00	0321303	189	24.90	0369203	198	18.30
0308305	185	156.00	0321305	189	47.30	0369204	198	24.30
0310101	182	3.50	0322501	190	24.90	0369205	198	36.80
0310102	182	3.80	0322503	190	39.00	0369206	198	48.90
0310103	182	4.20	0322510	190	4.40	0369207	198	68.00
0310105	182	4.70	0323308	189	16.20	0369208	198	130.00
0310107	182	6.00	0323318	189	20.70	0369209	198	180.00
0310108	182	7.10	0331011	195	109.00	0369210	198	302.00
0311101	182	3.50	0331030	195	128.00	0369211	198	564.00
0311102	182	4.00	0331111	195	142.00	0369212	198	1,059.00
0311103	182	4.70	0331130	195	162.00	0370102	200	9.80
0311105	182	5.60	0334101	195	72.00	0370103	200	10.90
0311107	182	6.80	0334102	195	119.00	0370104	200	11.10
0311108	182	7.30	0334105	195	87.00	0370105	200	18.10
0311120	182	2.20	0334106	195	132.00	0370106	200	24.10
0311121	182	18.30	0338354	195	140.00	0370107	200	29.40
0312101	187	3.30	0338357	195	182.00	0370108	200	80.00
0312103	187	4.70	0343501	188	255.00	0370109	200	117.00
0312105	187	5.70	0343503	188	287.00	0370110	200	164.00
0312107	187	7.00	0344501	188	125.00	0370111	200	367.00
0312108	187	8.40	0344502	188	159.00	0370112	200	621.00
0313101	187	3.30	0344503	188	202.00	0370202	200	13.50
0313103	187	4.70	0344505	188	428.00	0370203	200	16.40
0313105	187	5.70	0345522	192	373.00	0370204	200	22.40
0313107	187	7.00	0345530	192	467.00	0370205	200	29.80
0313108	187	8.40	0345534	192	643.00	0370206	200	44.80
0314002	185	74.00	0345722	193	539.00	0370207	200	54.00
0314003	185	84.00	0345730	193	674.00	0370208	200	161.00
0314004	185	88.00	0345734	193	934.00	0370209	200	198.00
0314005	185	94.00	0345910	192 / 193	119.00	0370210	200	336.00
0314102	185	112.00	0345912	192 / 193	132.00	0370211	200	520.00
0314103	185	133.00	0347522	192	477.00	0370212	200	841.00
0314104	185	137.00	0347530	192	602.00	0371102	200	7.40
0314105	185	142.00	0347534	192	830.00	0371103	200	7.80
0316110	183	7.40	0347722	193	664.00	0371104	200	9.40
0316111	183	29.10	0347730	193	830.00	0371105	200	12.80
0316151	183	125.00	0347734	193	1,142.00	0371106	200	19.40
0316152	183	157.00	0349722	194	570.00	0371107	200	23.00
0316153	183	190.00	0349730	194	726.00	0371108	200	58.00
0316154	183	244.00	0349734	194	986.00	0371109	200	82.00
0316201	183	141.00	0349910	194	109.00	0371110	200	113.00
0316202	183	195.00	0349912	194	128.00	0371111	200	250.00
0317001	184	65.00	0349914	194	142.00	0371112	200	429.00
0317002	184	92.00	0349916	194	162.00	0371202	200	9.00
0317003	184	119.00	0368102	198	15.40	0371203	200	10.90
0317004	184	163.00	0368103	198	17.90	0371204	200	15.40
0317005	184	375.00	0368104	198	27.10	0371205	200	21.30
0317006	184	610.00	0368105	198	34.70	0371206	200	31.00
0317007	184	814.00	0368106	198	50.00	0371207	200	37.80
0317010	184	8.10	0368107	198	68.00	0371208	200	125.00
0317101	184	78.00	0368108	198	148.00	0371209	200	156.00
0317102	184	105.00	0368109	198	216.00	0371210	200	258.00
0317103	184	136.00	0368110	198	309.00	0371211	200	473.00
0317104	184	177.00	0368111	198	528.00	0371212	200	763.00
0317105	184	391.00	0368112	198	947.00	0372102	201	7.60
0317106	184	615.00	0368202	198	23.00	0372103	201	8.50
0317107	184	810.00	0368203	198	24.80	0372104	201	11.10
0317110	184	23.00	0368204	198	42.60	0372105	201	14.20
0318201	190	148.00	0368205	198	61.00	0372106	201	19.30
0318203	190	157.00	0368206	198	89.00	0372107	201	24.30
0318210	190	12.50	0368207	198	100.00	0372108	201	40.80
0318211	190	40.50	0368208	198	187.00	0372109	201	54.00
0319001	191	35.30	0368209	198	259.00	0372110	201	73.00
0319002	191	44.20	0368210	198	385.00	0372111	201	92.00
0319003	191	63.00	0368211	198	661.00	0372112	201	127.00
0319004	191	85.00	0368212	198	1,403.00	0372113	201	455.00
0319010	191	3.70	0369102	198	10.10	0372114	201	732.00
0319101	191	45.20	0369103	198	11.30	0373102	201	5.40
0319102	191	53.00	0369104	198	13.90	0373103	201	6.20
0319103	191	73.00	0369105	198	23.00	0373104	201	8.50
0319104	191	92.00	0369106	198	31.80	0373105	201	10.30



Ref. No.	Page	List price €	Ref. No.	Page	List price €	Ref. No.	Page	List price €
0373106	201	14.20	0388103	205	23.00	0396453	210	12.70
0373107	201	18.20	0388104	205	27.50	0396454	210	14.30
0373108	201	27.40	0388105	205	37.00	0396455	210	15.90
0373109	201	40.10	0388106	205	52.00	0396456	210	19.50
0373110	201	54.00	0388108	205	90.00	0396982	211	11.40
0373111	201	72.00	0388202	205	23.00	0396983	211	13.50
0373112	201	105.00	0388203	205	27.10	0396984	211	16.10
0373113	201	349.00	0388204	205	32.60	0397101	206	177.00
0373114	201	644.00	0388205	205	42.10	0410301	213	23.90
0374404	202	6.30	0388206	205	62.00	0410302	213	30.10
0374408	202	7.10	0388208	205	136.00	0410303	213	34.30
0374410	202	8.60	0388210	205	649.00	0410304	213	51.00
0374412	202	10.50	0390102	204	34.70	0411101	213	21.70
0374414	202	12.70	0390103	204	34.70	0411102	213	27.10
0374416	202	16.00	0390104	204	40.20	0411103	213	34.00
0374418	202	21.40	0390105	204	51.00	0411104	213	45.00
0374420	202	28.80	0390106	204	69.00	0411105	213	68.00
0374424	202	34.20	0390108	204	116.00	0411106	213	79.00
0374428	202	52.00	0390202	204	46.00	0411107	213	104.00
0374430	202	181.00	0390203	204	52.00	0411108	213	134.00
0374432	202	267.00	0390204	204	66.00	0411109	213	142.00
0375404	202	5.10	0390205	204	85.00	0411110	213	148.00
0375408	202	5.30	0390206	204	107.00	0411301	213	24.10
0375410	202	5.70	0390208	204	164.00	0411302	213	31.00
0375412	202	6.90	0391102	204	54.00	0411303	213	34.50
0375414	202	7.60	0391103	204	54.00	0411304	213	49.50
0375416	202	10.40	0391104	204	70.00	0411305	213	99.00
0375418	202	11.50	0391105	204	88.00	0411306	213	125.00
0375420	202	14.10	0391106	204	119.00	0411307	213	135.00
0375424	202	16.80	0391108	204	174.00	0411308	213	141.00
0375428	202	21.70	0391202	204	64.00	0411309	213	149.00
0375430	202	85.00	0391203	204	72.00	0411310	213	183.00
0375432	202	128.00	0391204	204	82.00	0412201	214	34.00
0376102	203	11.80	0391205	204	105.00	0412202	214	36.80
0376103	203	12.60	0391206	204	134.00	0412203	214	37.80
0376104	203	15.80	0391208	204	218.00	0412204	214	53.00
0376105	203	26.00	0394101	205	203.00	0413301	214	22.90
0376112	203	11.00	0394104	205	36.80	0413302	214	23.90
0376113	203	11.70	0394110	205	82.00	0415301	215	62.00
0376114	203	14.20	0395102	209	26.90	0415302	215	97.00
0376115	203	19.90	0395103	209	29.80	0415303	215	131.00
0376116	203	24.60	0395104	209	40.20	0415304	215	180.00
0376117	203	29.30	0395106	209	18.90	0415305	215	204.00
0380103	207	55.00	0395107	209	20.70	0416301	215	125.00
0380104	207	65.00	0395108	209	29.80	0416302	215	163.00
0380105	207	82.00	0395122	209	25.40	0416303	215	211.00
0380106	207	90.00	0395123	209	29.10	0416304	215	349.00
0380107	207	98.00	0395124	209	39.00	0416305	215	405.00
0380108	207	251.00	0395126	209	18.20	0420121	217	15.60
0380109	207	447.00	0395127	209	20.30	0420122	217	60.00
0385102	199	24.30	0395128	209	28.60	0420124	217	85.00
0385103	199	25.90	0395132	208	8.30	0420201	217	54.00
0385104	199	31.00	0395133	208	10.60	0420202	217	58.00
0385105	199	46.30	0395134	208	12.80	0420203	217	62.00
0385106	199	64.00	0395136	208	8.30	0420206	217	17.70
0385108	199	112.00	0395137	208	10.60	0420207	217	18.50
0385202	199	33.70	0395138	208	12.80	0420208	217	18.70
0385203	199	37.40	0395142	208	18.30	0422501	216	145.00
0385204	199	46.30	0395143	208	20.70	0422502	216	153.00
0385205	199	61.00	0395144	208	27.10	0422503	216	161.00
0385206	199	79.00	0395146	208	13.50	0422504	216	169.00
0385208	199	116.00	0395147	208	18.30	0425211	216	27.50
0386102	199	18.30	0395148	208	24.80	0425212	216	31.00
0386103	199	19.70	0396290	210	92.00	0425213	216	34.70
0386104	199	24.10	0396414	207	14.80	0425214	216	48.90
0386105	199	29.80	0396416	207	17.60	0425701	216	1,130.00
0386106	199	38.50	0396418	207	20.80	0425702	216	1,140.00
0386108	199	74.00	0396420	207	26.00	0425703	216	1,150.00
0386202	199	23.20	0396426	207	31.20	0451101	222	24.80
0386203	199	26.30	0396432	211	9.40	0451102	222	57.00
0386204	199	31.00	0396433	211	11.60	0451103	222	102.00
0386205	199	40.20	0396434	211	14.20	0451104	222	141.00
0386206	199	52.00	0396435	211	18.20	0451105	222	292.00
0386208	199	103.00	0396436	211	20.30	0451106	222	530.00
0387200	206	17.20	0396443	210	10.10	0451201	222	43.90
0387201	206	17.20	0396444	210	11.90	0451202	222	101.00
0387204	206	40.20	0396445	210	12.90	0451203	222	150.00
0388102	205	19.40	0396446	210	16.60	0451204	222	263.00



Ref. No.	Page	List price €	Ref. No.	Page	List price €	Ref. No.	Page	List price €
0451205	222	530.00	0460224	220	1.50	0466101	225	21.30
0451206	222	958.00	0460225	220	4.10	0466102	225	37.40
0452101	222	19.50	0460226	220	8.80	0466103	225	42.60
0452103	222	38.50	0460227	220	3.10	0466104	225	82.00
0452104	222	56.00	0460228	220	7.40	0466105	225	111.00
0452105	222	91.00	0460229	220	15.40	0466106	225	246.00
0452106	222	144.00	0460230	220	24.80	0466107	225	384.00
0452107	222	159.00	0460231	220	29.80	0466108	225	913.00
0452108	222	304.00	0460232	220	69.00	0466109	225	1.375.00
0452109	222	547.00	0460233	220	107.00	0466201	226	36.80
0452201	222	26.00	0460241	220	1.00	0466202	226	64.00
0452203	222	57.00	0460242	220	1.00	0466203	226	94.00
0452204	222	97.00	0460243	220	1.50	0466204	226	196.00
0452205	222	154.00	0460244	220	1.50	0466205	226	330.00
0452206	222	294.00	0460245	220	4.10	0466206	226	549.00
0452207	222	305.00	0460246	220	8.80	0466207	226	784.00
0452208	222	549.00	0460247	220	3.10	0466208	226	1.460.00
0452209	222	1.046.00	0460248	220	7.40	0466209	226	2.188.00
0453422	221	8.50	0460249	220	15.40	0467011	228	621.00
0453430	221	12.70	0460250	220	24.80	0467012	228	888.00
0453434	221	18.70	0460251	220	29.80	0467013	228	1.156.00
0454424	224	9.00	0460252	220	69.00	0467014	228	1.489.00
0454428	224	11.20	0460253	220	107.00	0467015	228	2.492.00
0454434	224	22.30	0460501	221	2.60	0467016	228	3.464.00
0454438	224	40.50	0460502	221	4.10	0467017	228	6.013.00
0454440	224	61.00	0460504	221	4.70	0467111	228	457.00
0454444	224	162.00	0460505	221	10.30	0467112	228	616.00
0455424	224	16.60	0460506	221	20.90	0467113	228	822.00
0455428	224	20.70	0460507	221	5.40	0467114	228	1.125.00
0455434	224	39.30	0460508	221	11.30	0467115	228	1.515.00
0455438	224	70.00	0460509	221	23.60	0467116	228	1.994.00
0455440	224	103.00	0460510	221	69.00	0467117	228	3.160.00
0455444	224	217.00	0460511	221	108.00	0478012	229	165.00
0458102	223	36.80	0460512	221	227.00	0478015	229	289.00
0458103	223	43.90	0460521	221	2.60	0478016	229	364.00
0458104	223	57.00	0460522	221	4.10	0478017	229	471.00
0458105	223	68.00	0460524	221	4.70	0478018	229	578.00
0458106	223	82.00	0460525	221	10.30	0478019	229	716.00
0458107	223	94.00	0460526	221	20.90	0478021	229	898.00
0458108	223	232.00	0460527	221	5.40	0478024	229	1.283.00
0458109	223	249.00	0460528	221	11.30	0478027	229	2.010.00
0458110	223	320.00	0460529	221	23.60	0478112	229	130.00
0458111	223	490.00	0464101	225	63.00	0478115	229	214.00
0458112	223	500.00	0464102	225	90.00	0478116	229	289.00
0458113	223	510.00	0464103	225	141.00	0478117	229	364.00
0458114	223	520.00	0464104	225	238.00	0478118	229	406.00
0458115	223	530.00	0464105	225	427.00	0478119	229	524.00
0458116	223	540.00	0464106	225	726.00	0478121	229	578.00
0458117	223	675.00	0464107	225	1.114.00	0478124	229	962.00
0458202	223	65.00	0464108	225	1.915.00	0478127	229	1.710.00
0458203	223	83.00	0464109	225	2.380.00	0478312	228	97.00
0458204	223	101.00	0464201	226	100.00	0478315	228	155.00
0458205	223	133.00	0464202	226	136.00	0478316	228	187.00
0458206	223	161.00	0464203	226	257.00	0478317	228	224.00
0458207	223	188.00	0464204	226	427.00	0478318	228	289.00
0458252	223	295.00	0464205	226	790.00	0478319	228	428.00
0458253	223	310.00	0464206	226	1.375.00	0478321	228	471.00
0458254	223	330.00	0464207	226	2.432.00	0478324	228	673.00
0458255	223	380.00	0464208	226	4.338.00	0478327	228	1.069.00
0458256	223	415.00	0464209	226	5.485.00	0478907	230	275.00
0458257	223	490.00	0465101	225	31.00	0478908	230	275.00
0458258	223	570.00	0465102	225	51.00	0478909	230	295.00
0458291	223	414.00	0465103	225	69.00	0478911	230	310.00
0460201	220	1.00	0465104	225	127.00	0478914	230	350.00
0460202	220	1.00	0465105	225	257.00	0478917	230	420.00
0460204	220	1.50	0465106	225	482.00	0481023	230	302.00
0460205	220	4.10	0465107	225	827.00	0481024	230	437.00
0460206	220	8.80	0465108	225	1.337.00	0481025	230	657.00
0460207	220	3.10	0465109	225	2.317.00	0481028	230	1.091.00
0460208	220	7.40	0465201	226	57.00	0481030	230	1.246.00
0460209	220	15.40	0465202	226	87.00	0481034	230	2.056.00
0460210	220	24.80	0465203	226	157.00	0481043	230	257.00
0460211	220	29.80	0465204	226	246.00	0481044	230	375.00
0460212	220	69.00	0465205	226	580.00	0481045	230	557.00
0460213	220	107.00	0465206	226	883.00	0481048	230	935.00
0460221	220	1.00	0465207	226	1.701.00	0481050	230	1.185.00
0460222	220	1.00	0465208	226	2.505.00	0481054	230	1.869.00
0460223	220	1.50	0465209	226	4.593.00	0481103	230	220.00



Ref. No.	Page	List price €	Ref. No.	Page	List price €	Ref. No.	Page	List price €
0481104	230	319.00	0524103	234	401.00	0595140	240	2.60
0481105	230	486.00	0525101	235	115.00	0595142	240	2.60
0481108	230	810.00	0525102	235	123.00	0595251	243	87.00
0481110	230	1,078.00	0525103	235	131.00	0597301	63 / 244	168.00
0481114	230	1,715.00	0527101	235	326.00	0597305	63 / 244	168.00
0481160	231	339.00	0527102	235	452.00	0598101	245	46.80
0481161	231	351.00	0527104	235	641.00	0598103	245	46.80
0481162	231	370.00	0527105	235	896.00	0598105	245	46.80
0481165	231	395.00	0527107	235	387.00	0598601	245	46.80
0481167	231	414.00	0527108	235	539.00	0599101	245	46.80
0481170	231	470.00	0527110	235	823.00	0599102	245	57.00
0481184	231	1,098.00	0527111	235	1,066.00	0599151	245	6.80
0481186	231	1,209.00	0536201	236	375.00	0599152	245	6.80
0481188	231	1,255.00	0536202	236	420.00	0600101	246	24.80
0481190	231	1,403.00	0536211	236	524.00	0600102	246	31.00
0482101	229	468.00	0536212	236	619.00	0600103	246	33.20
0504012	232	89.00	0536213	236	624.00	0600111	246	53.00
0504013	232	139.00	0536220	236	99.00	0600112	246	70.00
0504014	232	214.00	0536230	236	135.00	0600113	246	146.00
0504112	232	63.00	0544101	231	332.00	0600114	246	227.00
0504113	232	84.00	0544102	231	512.00	0600115	246	365.00
0504114	232	139.00	0544103	231	709.00	0601103	246	87.00
0504312	232	43.70	0544104	231	896.00	0601120	246	66.00
0504313	232	64.00	0544105	231	1,524.00	0604002	246	6.50
0504314	232	106.00	0544106	231	2,296.00	0604004	246	7.20
0508011	233	295.00	0544107	231	4,381.00	0604006	246	7.20
0508012	233	355.00	0550021	237	255.00	0604013	247	51.00
0508013	233	520.00	0550022	237	280.00	0604014	247	51.00
0508111	233	255.00	0550023	237	305.00	0604015	247	51.00
0508112	233	315.00	0550024	237	330.00	0604016	247	51.00
0508113	233	480.00	0550101	237	180.00	0604017	247	51.00
0512101	227	10.10	0550102	237	205.00	0604018	247	51.00
0512102	227	11.30	0550103	237	230.00	0604019	247	51.00
0512103	227	12.80	0550104	237	255.00	0604020	247	51.00
0512104	227	14.50	0550131	237	140.00	0604021	247	51.00
0512105	227	18.90	0550132	237	165.00	0604022	247	51.00
0512106	227	35.60	0550133	237	190.00	0604023	247	51.00
0512107	227	63.00	0550134	237	215.00	0604024	247	51.00
0512108	227	100.00	0551002	237	270.00	0604025	247	33.00
0512201	227	13.10	0551003	237	322.00	0604026	247	33.00
0512202	227	15.40	0551012	237	171.00	0604027	247	33.00
0512203	227	16.00	0551013	237	192.00	0604028	247	33.00
0512204	227	17.90	0551021	237	161.00	0604029	247	33.00
0512205	227	20.70	0556022	238	490.00	0604030	247	33.00
0512206	227	45.00	0556023	238	560.00	0604031	247	33.00
0512207	227	82.00	0556024	238	790.00	0604032	247	33.00
0512208	227	111.00	0556101	238	300.00	0604033	247	33.00
0512209	227	215.00	0556102	238	350.00	0604034	247	33.00
0512210	227	436.00	0556103	238	440.00	0604035	247	33.00
0512211	227	571.00	0556104	238	700.00	0604036	247	33.00
0512601	227	5.20	0556131	238	250.00	0604037	247	34.70
0512602	227	5.20	0556132	238	300.00	0604038	247	34.70
0512603	227	5.20	0556133	238	460.00	0604039	247	34.70
0512604	227	6.20	0556134	238	550.00	0604040	247	34.70
0512605	227	7.30	0560001	238	294.00	0604041	247	34.70
0512606	227	8.30	0563001	238	400.00	0604042	247	34.70
0512607	227	10.40	0580101	239	7.10	0604043	247	34.70
0512608	227	15.60	0580111	239	10.30	0604044	247	34.70
0512609	227	15.60	0580121	239	7.20	0604045	247	34.70
0512610	227	31.20	0580151	239	3.00	0604046	247	34.70
0512611	227	36.40	0581101	241	20.70	0604047	247	36.60
0513001	232	165.00	0581103	241	14.00	0604048	247	36.60
0513002	232	190.00	0581105	241	19.20	0604049	247	36.60
0513011	232	180.00	0581123	241	10.10	0604050	247	36.60
0513012	232	210.00	0581125	241	8.80	0604051	247	36.60
0520101	233	128.00	0582110	241	59.00	0604052	247	36.60
0520102	233	168.00	0582120	241	59.00	0604053	247	36.60
0520103	233	223.00	0582130	241	59.00	0604054	247	36.60
0520104	233	311.00	0584101	252	304.00	0604055	247	36.60
0520105	233	425.00	0589101	242	16.20	0604056	247	36.60
0522101	234	196.00	0589103	242	49.50	0604057	247	38.10
0522102	234	239.00	0590101	242	1.70	0604058	247	38.10
0522103	234	345.00	0590111	242	62.00	0604059	247	38.10
0522111	234	19.70	0590151	243	3.30	0604060	247	38.10
0522112	234	26.00	0595101	244	20.30	0604061	247	38.10
0522113	234	33.20	0595110	243	12.70	0604062	247	38.10
0524101	234	179.00	0595115	243	3.60	0604063	247	38.10
0524102	234	267.00	0595130	240	3.00	0604064	247	38.10



Ref. No.	Page	List price €	Ref. No.	Page	List price €	Ref. No.	Page	List price €
0604065	247	38.10	0611300	250	76.00	0613234	253	25.20
0604066	247	38.10	0611501	250	30.00	0613236	253	25.20
0604067	247	41.60	0611502	250	24.90	0613238	253	25.20
0604068	247	41.60	0611503	250	8.60	0613240	253	25.20
0604069	247	41.60	0611504	250	8.60	0613242	253	25.20
0604070	247	41.60	0611505	250	6.50	0613244	253	27.50
0604071	247	41.60	0611506	250	6.80	0613246	253	27.50
0604072	247	41.60	0611507	250	6.80	0613248	253	27.50
0604073	247	41.60	0611508	250	6.80	0613250	253	27.50
0604074	247	41.60	0611509	250	6.80	0613252	253	44.80
0604075	247	41.60	0611510	250	5.80	0613254	253	44.80
0604076	247	41.60	0611512	250	5.80	0613256	253	44.80
0604077	247	50.00	0611515	250	5.80	0613258	253	44.80
0604078	247	50.00	0611518	250	7.60	0613260	253	44.80
0604079	247	50.00	0611520	250	5.80	0613309	253	90.00
0604080	247	50.00	0611525	250	5.80	0613318	253	54.00
0604081	247	50.00	0611530	250	6.70	0613330	253	51.00
0604082	247	50.00	0611535	250	6.70	0613334	253	51.00
0604083	247	50.00	0611540	250	7.70	0613338	253	65.00
0604084	247	50.00	0611545	250	7.70	0613342	253	65.00
0604085	247	50.00	0611550	250	7.70	0613346	253	74.00
0604086	247	50.00	0611552	250	9.90	0613350	253	84.00
0604087	247	54.00	0611554	250	9.90	0613352	253	101.00
0604088	247	57.00	0611556	250	9.90	0613354	253	101.00
0604089	247	60.00	0611558	250	9.90	0613356	253	121.00
0604090	247	69.00	0611560	250	9.90	0613358	253	121.00
0604091	247	69.00	0611562	250	9.90	0613360	253	138.00
0604092	247	69.00	0611564	250	10.10	0613412	253	103.00
0604093	247	69.00	0611566	250	10.60	0613418	253	83.00
0604094	247	69.00	0611568	250	10.60	0613424	253	83.00
0604095	247	69.00	0611570	250	10.60	0613430	253	79.00
0604096	247	69.00	0612180	251	195.00	0613434	253	79.00
0604202	246	8.60	0612501	251	39.50	0613438	253	99.00
0604204	246	10.70	0612502	251	33.00	0613440	253	99.00
0604206	246	10.70	0612503	251	11.50	0613442	253	99.00
0605101	248	2.40	0612504	251	11.50	0613446	253	109.00
0605102	248	2.20	0612505	251	8.50	0613450	253	128.00
0605103	248	2.20	0612506	251	8.90	0613512	253	102.00
0605104	248	2.20	0612507	251	8.90	0613518	253	82.00
0605105	248	3.30	0612508	251	8.90	0613524	253	82.00
0605106	248	3.50	0612509	251	8.90	0613530	253	78.00
0605107	248	4.90	0612510	251	7.70	0613534	253	78.00
0605108	248	2.90	0612512	251	7.70	0613538	253	97.00
0605109	248	3.10	0612515	251	7.70	0613540	253	97.00
0605110	248	2.90	0612518	251	9.90	0613542	253	97.00
0605111	248	2.90	0612520	251	7.70	0613546	253	108.00
0605112	248	3.30	0612525	251	7.70	0613550	253	127.00
0606121	248	1.50	0613107	253	65.00	0613607	254	65.00
0606123	248	1.50	0613109	253	35.20	0613609	254	35.20
0606127	248	1.50	0613114	253	24.80	0613614	254	24.80
0606130	248	2.40	0613116	253	24.80	0613616	254	24.80
0606131	248	5.90	0613118	253	24.80	0613618	254	24.80
0606132	248	2.90	0613120	253	16.90	0613620	254	16.90
0606133	248	5.40	0613122	253	16.90	0613622	254	16.90
0606136	248	4.90	0613126	253	16.90	0613626	254	16.90
0606150	249	3.30	0613128	253	16.90	0613628	254	16.90
0606152	249	3.90	0613130	253	17.50	0613630	254	17.50
0606154	249	5.70	0613134	253	17.50	0613632	254	17.50
0606160	249	8.50	0613138	253	17.50	0613634	254	17.50
0606162	249	9.80	0613142	253	17.50	0613636	254	17.50
0606170	249	10.30	0613146	253	19.40	0613638	254	17.50
0606172	249	13.00	0613150	253	19.40	0613640	254	17.50
0606176	249	17.20	0613152	253	31.00	0613642	254	17.50
0606178	249	25.10	0613154	253	31.00	0613644	254	19.40
0607201	248	3.70	0613156	253	31.00	0613646	254	19.40
0607202	248	5.90	0613158	253	31.00	0613648	254	19.40
0607203	248	8.40	0613160	253	31.00	0613650	254	19.40
0607401	248	6.30	0613207	253	94.00	0613652	254	31.00
0607402	248	7.80	0613209	253	51.00	0613654	254	31.00
0607403	248	11.10	0613214	253	35.60	0613656	254	31.00
0608140	249	1.85	0613216	253	35.60	0613658	254	31.00
0608143	249	4.45	0613218	253	35.60	0613660	254	31.00
0608144	249	6.95	0613220	253	24.30	0613709	254	48.50
0608149	249	15.95	0613222	253	24.30	0613718	254	29.40
0609190	252	79.00	0613226	253	24.30	0613730	254	27.50
0611180	250	149.00	0613228	253	24.30	0613734	254	27.50
0611190	250	169.00	0613230	253	25.20	0613738	254	34.70
0611195	251	2.60	0613232	253	25.20	0613742	254	34.70



Ref. No.	Page	List price €	Ref. No.	Page	List price €	Ref. No.	Page	List price €
0613746	254	39.20	0623320	255	34.30	0624120	256	22.90
0613750	254	44.80	0623325	255	34.30	0624122	256	22.90
0613752	254	54.00	0623330	255	34.30	0624130	256	22.90
0613754	254	54.00	0623335	255	34.30	0624135	256	22.90
0613756	254	65.00	0623340	255	34.30	0624140	256	22.90
0613758	254	65.00	0623345	255	34.30	0624145	256	22.90
0613760	254	72.00	0623350	255	34.30	0624150	256	22.90
0613812	254	54.00	0623355	255	34.30	0624155	256	22.90
0613818	254	43.70	0623360	255	34.30	0624160	256	22.90
0613824	254	43.70	0623365	255	34.30	0624165	256	22.90
0613830	254	41.40	0623370	255	34.30	0624170	256	22.90
0613834	254	41.40	0623375	255	34.30	0624175	256	22.90
0613838	254	52.00	0623380	255	34.30	0624180	256	22.90
0613840	254	52.00	0623385	255	34.30	0624185	256	22.90
0613842	254	52.00	0623390	255	34.30	0624190	256	22.90
0613846	254	60.00	0623395	255	34.30	0624195	256	22.90
0613850	254	70.00	0623400	255	36.40	0624200	256	22.90
0613860	254	113.00	0623405	255	36.40	0624205	256	22.90
0613912	254	54.00	0623410	255	36.40	0624210	256	22.90
0613918	254	43.20	0623415	255	36.40	0624215	256	22.90
0613924	254	43.20	0623420	255	36.40	0624220	256	22.90
0613930	254	41.00	0623425	255	36.40	0624225	256	22.90
0613934	254	41.00	0623430	255	36.40	0624230	256	22.90
0613938	254	51.00	0623435	255	36.40	0624235	256	22.90
0613940	254	51.00	0623440	255	36.40	0624240	256	22.90
0613942	254	51.00	0623445	255	36.40	0624245	256	22.90
0613946	254	60.00	0623450	255	36.40	0624250	256	22.90
0613950	254	69.00	0623455	255	36.40	0624255	256	22.90
0623100	255	40.50	0623460	255	36.40	0624260	256	22.90
0623102	255	34.30	0623465	255	36.40	0624265	256	22.90
0623104	255	34.30	0623470	255	36.40	0624270	256	22.90
0623106	255	34.30	0623475	255	43.60	0624275	256	22.90
0623108	255	34.30	0623500	255	43.60	0624280	256	22.90
0623110	255	34.30	0623510	255	43.60	0624285	256	22.90
0623112	255	34.30	0623520	255	43.60	0624290	256	22.90
0623114	255	34.30	0623530	255	43.60	0624295	256	22.90
0623116	255	34.30	0623540	255	43.60	0624300	256	22.90
0623118	255	34.30	0623550	255	43.60	0624305	256	22.90
0623120	255	34.30	0623560	255	43.60	0624310	256	22.90
0623122	255	34.30	0623570	255	43.60	0624315	256	22.90
0623130	255	34.30	0623580	255	43.60	0624320	256	22.90
0623135	255	34.30	0623590	255	43.60	0624325	256	22.90
0623140	255	34.30	0623600	255	43.60	0624330	256	22.90
0623145	255	34.30	0623610	255	43.60	0624335	256	22.90
0623150	255	34.30	0623620	255	43.60	0624340	256	22.90
0623155	255	34.30	0623630	255	43.60	0624345	256	22.90
0623160	255	34.30	0623640	255	43.60	0624350	256	22.90
0623165	255	34.30	0623650	255	52.00	0624355	256	22.90
0623170	255	34.30	0623660	255	52.00	0624360	256	22.90
0623175	255	34.30	0623670	255	52.00	0624365	256	22.90
0623180	255	34.30	0623680	255	52.00	0624370	256	22.90
0623185	255	34.30	0623690	255	52.00	0624375	256	22.90
0623190	255	34.30	0623700	255	52.00	0624380	256	22.90
0623195	255	34.30	0623710	255	64.00	0624385	256	22.90
0623200	255	34.30	0623720	255	64.00	0624390	256	22.90
0623205	255	34.30	0623730	255	77.00	0624395	256	22.90
0623210	255	34.30	0623740	255	272.00	0624400	256	23.90
0623215	255	34.30	0623750	255	272.00	0624405	256	23.90
0623220	255	34.30	0623760	255	272.00	0624410	256	23.90
0623225	255	34.30	0623770	255	324.00	0624415	256	23.90
0623230	255	34.30	0623780	255	463.00	0624420	256	23.90
0623235	255	34.30	0623790	255	601.00	0624425	256	23.90
0623240	255	34.30	0623800	255	831.00	0624430	256	23.90
0623245	255	34.30	0623810	255	1,298.00	0624435	256	23.90
0623250	255	34.30	0623820	255	1,346.00	0624440	256	23.90
0623255	255	34.30	0623830	255	1,662.00	0624445	256	23.90
0623260	255	34.30	0623840	255	1,970.00	0624450	256	23.90
0623265	255	34.30	0623850	255	2,442.00	0624455	256	23.90
0623270	255	34.30	0624100	256	27.00	0624460	256	23.90
0623275	255	34.30	0624102	256	22.90	0624465	256	23.90
0623280	255	34.30	0624104	256	22.90	0624470	256	23.90
0623285	255	34.30	0624106	256	22.90	0624475	256	29.10
0623290	255	34.30	0624108	256	22.90	0624500	256	29.10
0623295	255	34.30	0624110	256	22.90	0624510	256	29.10
0623300	255	34.30	0624112	256	22.90	0624520	256	29.10
0623305	255	34.30	0624114	256	22.90	0624530	256	29.10
0623310	255	34.30	0624116	256	22.90	0624540	256	29.10
0623315	255	34.30	0624118	256	22.90	0624550	256	29.10



Ref. No.	Page	List price €	Ref. No.	Page	List price €	Ref. No.	Page	List price €
0624560	256	29.10	0625310	257	18.70	0633120	262	225.00
0624570	256	29.10	0625315	257	18.70	0633130	258	1,105.00
0624580	256	29.10	0625320	257	18.70	0633131	258	1,283.00
0624590	256	29.10	0625325	257	18.70	0633132	258	1,660.00
0624600	256	29.10	0625330	257	18.70	0633133	258	3,279.00
0624610	256	29.10	0625335	257	18.70	0633136	260	175.00
0624620	256	29.10	0625340	257	18.70	0633137	260	200.00
0624630	256	29.10	0625345	257	18.70	0633138	260	240.00
0624640	256	29.10	0625350	257	18.70	0633139	260	220.00
0624650	256	34.30	0625355	257	18.70	0633140	260	260.00
0624660	256	34.30	0625360	257	18.70	0633141	260	300.00
0624670	256	34.30	0625365	257	18.70	0633142	260	340.00
0624680	256	34.30	0625370	257	18.70	0633143	260	370.00
0624690	256	34.30	0625375	257	18.70	0633144	260	430.00
0624700	256	34.30	0625380	257	18.70	0633145	260	600.00
0624710	256	42.60	0625385	257	18.70	0633150	258	205.00
0624720	256	42.60	0625390	257	18.70	0633151	258	205.00
0624730	256	51.00	0625395	257	18.70	0633152	258	220.00
0624740	256	165.00	0625400	257	18.70	0633153	258	270.00
0624750	256	165.00	0625405	257	18.70	0633154	258	380.00
0624760	256	165.00	0625410	257	18.70	0633155	258	495.00
0624770	256	196.00	0625415	257	18.70	0633170	258	245.00
0624780	256	281.00	0625420	257	18.70	0633171	259	89.00
0624790	256	364.00	0625425	257	18.70	0633172	259	360.00
0624800	256	504.00	0625430	257	18.70	0633173	259	115.00
0624810	256	701.00	0625435	257	18.70	0633174	259	200.00
0624820	256	727.00	0625440	257	18.70	0633175	259	235.00
0624830	256	899.00	0625445	257	18.70	0633176	259	370.00
0624840	256	1,065.00	0625450	257	18.70	0633177	259	440.00
0624850	256	1,320.00	0625455	257	18.70	0633178	259	215.00
0625100	257	21.80	0625460	257	18.70	0633179	259	270.00
0625102	257	18.70	0625465	257	18.70	0633180	259	325.00
0625104	257	18.70	0625470	257	18.70	0633181	259	485.00
0625106	257	18.70	0625475	257	22.90	0633182	260	155.00
0625108	257	18.70	0625500	257	22.90	0633214	263	415.00
0625110	257	18.70	0625510	257	22.90	0633216	263	327.00
0625112	257	18.70	0625520	257	22.90	0633218	263	224.00
0625114	257	18.70	0625530	257	22.90	0633220	263	148.00
0625116	257	18.70	0625540	257	22.90	0633805	261	325.00
0625118	257	18.70	0625550	257	22.90	0633808	261	435.00
0625120	257	18.70	0625560	257	22.90	0633810	261	264.00
0625122	257	18.70	0625570	257	22.90	0633833	36 / 261	540.00
0625130	257	18.70	0625580	257	22.90	0633834	36 / 261	721.00
0625135	257	18.70	0625590	257	22.90	0633836	36 / 261	1,287.00
0625140	257	18.70	0625600	257	22.90	0633838	36 / 261	2,275.00
0625145	257	18.70	0625610	257	22.90	0634014	264	4,389.00
0625150	257	18.70	0625620	257	22.90	0634016	264	3,616.00
0625155	257	18.70	0625630	257	22.90	0634017	264	2,363.00
0625160	257	18.70	0625640	257	22.90	0634020	264	1,241.00
0625165	257	18.70	0625650	257	27.00	0634114	264	3,863.00
0625170	257	18.70	0625660	257	27.00	0634116	264	3,158.00
0625175	257	18.70	0625670	257	27.00	0634117	264	2,117.00
0625180	257	18.70	0625680	257	27.00	0634120	264	1,077.00
0625185	257	18.70	0625690	257	27.00	0634514	265	6,128.00
0625190	257	18.70	0625700	257	27.00	0634516	265	4,880.00
0625195	257	18.70	0625710	257	34.30	0634517	265	2,910.00
0625200	257	18.70	0625720	257	34.30	0634520	265	1,767.00
0625205	257	18.70	0625730	257	40.50	0634614	265	5,130.00
0625210	257	18.70	0625740	257	132.00	0634616	265	4,077.00
0625215	257	18.70	0625750	257	132.00	0634617	265	2,432.00
0625220	257	18.70	0625760	257	132.00	0634620	265	1,474.00
0625225	257	18.70	0625770	257	141.00	0636301	266	779.00
0625230	257	18.70	0625780	257	223.00	0636321	266	236.00
0625235	257	18.70	0625790	257	262.00	0636322	266	236.00
0625240	257	18.70	0625800	257	343.00	0636323	266	292.00
0625245	257	18.70	0625810	257	426.00	0636324	266	292.00
0625250	257	18.70	0625820	257	509.00	0636325	266	292.00
0625255	257	18.70	0625830	257	630.00	0636326	266	356.00
0625260	257	18.70	0625840	257	746.00	0636327	266	356.00
0625265	257	18.70	0625850	257	924.00	0636328	266	356.00
0625270	257	18.70	0633001	260	301.00	0636329	266	356.00
0625275	257	18.70	0633014	262	853.00	0636341	266	992.00
0625280	257	18.70	0633016	262	779.00	0636342	266	992.00
0625285	257	18.70	0633018	262	507.00	0636343	266	1,257.00
0625290	257	18.70	0633020	262	370.00	0636344	266	1,257.00
0625295	257	18.70	0633114	262	656.00	0636345	266	1,257.00
0625300	257	18.70	0633116	262	500.00	0636346	266	1,547.00
0625305	257	18.70	0633118	262	309.00	0636347	266	1,547.00



Ref. No.	Page	List price €	Ref. No.	Page	List price €	Ref. No.	Page	List price €
0636348	266	1,547.00	0637166	268	89.00	0656334	271	60.00
0636349	266	1,547.00	0637167	268	91.00	0656335	271	60.00
0636351	266	1,268.00	0637168	268	95.00	0656336	271	61.00
0636352	266	1,152.00	0637169	268	100.00	0656337	271	57.00
0636372	266	694.00	0637170	268	101.00	0656338	271	64.00
0636373	266	694.00	0637171	268	104.00	0656339	271	64.00
0636374	266	914.00	0637172	268	106.00	0656340	271	65.00
0636375	266	914.00	0637173	268	109.00	0656341	271	65.00
0636376	266	914.00	0637174	268	111.00	0656342	271	66.00
0636377	266	1,107.00	0637190	268	142.00	0656343	271	68.00
0636378	266	1,255.00	0649201	269	69.00	0656344	271	69.00
0636379	266	1,255.00	0649202	269	69.00	0656345	271	70.00
0636380	266	1,255.00	0649203	269	69.00	0656346	271	74.00
0636392	267	12.70	0649204	269	71.00	0656347	271	78.00
0636393	267	14.50	0649205	269	71.00	0656348	271	80.00
0636394	267	27.50	0649206	269	75.00	0656349	271	82.00
0636395	267	35.30	0649207	269	75.00	0656350	271	84.00
0636396	267	40.70	0649208	269	78.00	0656351	271	86.00
0637103	268	29.80	0649209	269	78.00	0656352	271	89.00
0637104	268	29.80	0649210	269	82.00	0656353	271	91.00
0637105	268	29.80	0649211	269	82.00	0656354	271	100.00
0637106	268	21.70	0649212	269	89.00	0656355	271	104.00
0637107	268	21.70	0649213	269	89.00	0656356	271	108.00
0637108	268	19.40	0649215	269	99.00	0656357	271	111.00
0637109	268	19.40	0649216	269	113.00	0656358	271	118.00
0637110	268	19.40	0649217	269	113.00	0656359	271	127.00
0637111	268	18.30	0649219	269	135.00	0656360	271	131.00
0637112	268	18.30	0649220	269	176.00	0656361	271	136.00
0637113	268	19.40	0649222	269	202.00	0656362	271	140.00
0637114	268	19.40	0649223	269	202.00	0656363	271	148.00
0637115	268	20.70	0650101	270	877.00	0656364	271	153.00
0637116	268	21.70	0650102	270	958.00	0656365	271	161.00
0637117	268	21.70	0650103	270	1,053.00	0656366	271	172.00
0637118	268	23.00	0650104	270	1,153.00	0656367	271	183.00
0637119	268	24.10	0650105	270	1,661.00	0656368	271	189.00
0637120	268	24.10	0650106	270	1,880.00	0656369	271	197.00
0637121	268	24.80	0650107	270	2,156.00	0656370	271	210.00
0637122	268	24.80	0650108	270	2,245.00	0656371	271	220.00
0637123	268	25.90	0650109	270	2,382.00	0656372	271	227.00
0637124	268	26.90	0650110	270	2,578.00	0656373	271	238.00
0637125	268	26.90	0650111	270	2,767.00	0656374	271	250.00
0637126	268	26.90	0650112	270	2,957.00	0656375	271	261.00
0637127	268	28.30	0650113	270	3,148.00	0656376	271	273.00
0637128	268	28.90	0650114	270	3,402.00	0656377	271	285.00
0637129	268	29.80	0650115	270	4,346.00	0656378	271	295.00
0637130	268	29.80	0650116	270	4,533.00	0656379	271	307.00
0637131	268	31.00	0650117	270	4,731.00	0656380	271	318.00
0637132	268	32.20	0650118	270	4,924.00	0656381	271	329.00
0637133	268	32.20	0650119	270	5,116.00	0656382	271	341.00
0637134	268	33.20	0656303	271	48.20	0656383	271	372.00
0637135	268	33.20	0656304	271	72.00	0656384	271	402.00
0637136	268	36.80	0656305	271	857.00	0656385	271	432.00
0637137	268	37.40	0656306	271	943.00	0656386	271	464.00
0637138	268	38.50	0656309	271	55.00	0656387	271	495.00
0637139	268	38.50	0656310	271	48.20	0656388	271	525.00
0637140	268	39.40	0656311	271	48.20	0656389	271	557.00
0637141	268	40.20	0656312	271	48.20	0656390	271	586.00
0637142	268	41.40	0656313	271	47.20	0656391	271	618.00
0637144	268	42.60	0656314	271	46.00	0656392	271	648.00
0637146	268	43.90	0656315	271	46.00	0656393	271	683.00
0637147	268	54.00	0656316	271	46.00	0656394	271	713.00
0637148	268	47.20	0656317	271	46.00	0656395	271	747.00
0637149	268	48.20	0656318	271	46.00	0656396	271	780.00
0637150	268	48.90	0656319	271	47.20	0656397	271	814.00
0637151	268	51.00	0656320	271	48.20	0656398	271	847.00
0637152	268	52.00	0656321	271	48.90	0656399	271	879.00
0637154	268	54.00	0656322	271	48.90	0658001	272	142.00
0637155	268	57.00	0656323	271	50.00	0658002	272	137.00
0637156	268	60.00	0656324	271	50.00	0658003	272	119.00
0637157	268	64.00	0656325	271	51.00	0658004	272	104.00
0637158	268	66.00	0656326	271	51.00	0658005	272	91.00
0637159	268	70.00	0656327	271	52.00	0658006	272	91.00
0637160	268	70.00	0656328	271	54.00	0658007	272	84.00
0637161	268	77.00	0656329	271	54.00	0658008	272	79.00
0637162	268	78.00	0656330	271	54.00	0658009	272	65.00
0637163	268	80.00	0656331	271	57.00	0658010	272	64.00
0637164	268	84.00	0656332	271	58.00	0658011	272	61.00
0637165	268	88.00	0656333	271	59.00	0658012	272	60.00

Order number index



Ref. No.	Page	List price €	Ref. No.	Page	List price €	Ref. No.	Page	List price €
0658013	272	58.00	0658613	274	47.20	0710113	136	4.30
0658014	272	59.00	0658614	274	47.20	0710114	136	4.30
0658015	272	60.00	0658615	274	48.20	0710115	136	4.30
0658016	272	61.00	0658616	274	51.00	0710116	136	4.30
0658017	272	64.00	0658617	274	57.00	0710117	136	4.30
0658018	272	101.00	0658618	274	65.00	0710118	136	4.30
0658019	272	69.00	0658619	274	66.00	0710119	136	4.30
0658020	272	74.00	0658620	274	72.00	0710120	136	4.30
0658021	272	80.00	0658621	274	80.00	0710121	136	4.30
0658022	272	85.00	0658622	274	91.00	0710122	136	4.30
0658023	272	90.00	0658623	274	102.00	0710123	136	4.30
0658024	272	97.00	0658624	274	110.00	0710124	136	4.30
0658025	272	108.00	0658625	274	118.00	0710125	136	4.30
0658026	272	118.00	0658626	274	133.00	0710126	136	4.30
0658027	272	132.00	0658627	274	143.00	0710127	136	4.30
0658028	272	143.00	0658628	274	158.00	0710128	136	4.30
0658029	272	156.00	0658629	274	169.00	0710129	136	4.30
0658030	272	172.00	0658630	274	184.00	0710161	137	3.50
0658031	272	254.00	0658631	274	201.00	0710162	137	4.50
0658032	272	274.00	0658632	274	212.00	0710163	137	5.20
0658033	272	296.00	0658633	274	224.00	0710164	137	5.20
0658034	272	317.00	0658634	274	243.00	0710165	137	6.50
0658035	272	351.00	0658635	274	257.00	0710166	138	4.70
0658036	272	372.00	0658636	274	274.00	0710167	138	3.30
0658037	272	407.00	0658637	274	294.00	0710168	138	3.30
0658038	272	433.00	0658638	274	311.00	0710169	138	6.50
0658090	272	242.00	0658690	275	242.00	0710170	138	6.50
0658501	273	143.00	0691731	128	363.00	0710171	138	6.50
0658502	273	136.00	0691733	128	416.00	0710172	138	6.50
0658503	273	126.00	0691735	128	905.00	0710173	138	6.50
0658504	273	91.00	0691737	128	1,020.00	0710174	138	6.50
0658505	273	83.00	0691741	128	448.00	0710175	138	6.50
0658506	273	83.00	0691743	128	491.00	0710176	138	6.50
0658507	273	72.00	0691745	128	1,003.00	0710177	138	6.50
0658508	273	62.00	0691747	128	1,158.00	0710178	138	6.50
0658509	273	51.00	0691751	128	521.00	0710179	138	6.50
0658510	273	48.20	0691753	128	576.00	0710180	138	6.50
0658511	273	47.20	0700100	132	60.00	0710181	139	6.50
0658512	273	47.20	0700101	132	60.00	0710182	139	6.50
0658513	273	47.20	0700102	132	46.00	0710183	139	6.50
0658514	273	47.20	0700104	132	53.00	0710184	139	6.50
0658515	273	48.20	0701101	129	40.00	0710185	139	6.50
0658516	273	51.00	0701102	129	50.00	0710186	139	6.50
0658517	273	57.00	0701103	130	23.00	0710187	139	6.50
0658518	273	64.00	0701106	130	24.00	0710188	139	6.50
0658519	273	66.00	0701110	130	40.00	0710189	139	6.50
0658520	273	72.00	0701111	130	46.00	0710192	139	6.90
0658521	273	80.00	0702106	132	61.00	0710193	139	3.50
0658522	273	91.00	0703101	130	99.00	0710194	139	4.70
0658523	273	102.00	0703104	130	137.00	0710195	140	1.10
0658524	273	110.00	0703107	130	275.00	0710196	140	7.60
0658525	273	118.00	0704105	131	70.00	0710197	140	1.10
0658526	273	133.00	0704106	131	86.00	0710261	137	23.80
0658527	273	143.00	0704109	131	113.00	0710262	137	38.40
0658528	273	158.00	0704110	131	146.00	0710263	137	46.30
0658529	273	169.00	0705102	133	108.00	0710264	137	44.80
0658530	273	184.00	0705104	133	108.00	0710265	137	20.60
0658531	273	201.00	0705105	133	113.00	0710267	138	10.90
0658532	273	212.00	0705107	133	115.00	0710268	138	10.90
0658533	273	224.00	0705109	133	140.00	0710292	139	48.70
0658534	273	243.00	0706102	133	70.00	0710297	140	4.50
0658535	273	257.00	0707101	131	124.00	0710367	138	8.50
0658536	273	274.00	0707102	131	106.00	0710368	138	8.50
0658537	273	294.00	0708101	129	86.00	0710397	140	6.10
0658538	273	311.00	0708102	129	55.00	0710467	138	8.50
0658590	275	242.00	0708103	129	66.00	0710468	138	8.50
0658601	274	143.00	0708104	129	45.00	0710497	140	6.10
0658602	274	136.00	0708105	129	55.00	0712121	134	149.00
0658603	274	126.00	0708106	129	73.00	0712124	134	182.00
0658604	274	91.00	0709101	134	104.00	0715101	141	77.00
0658605	274	83.00	0709108	134	124.00	0715103	141	86.00
0658606	274	83.00	0710101	135	51.00	0715201	141	121.00
0658607	274	72.00	0710102	135	6.30	0715303	141	108.00
0658608	274	62.00	0710103	135	6.50	0715305	141	103.00
0658609	274	51.00	0710104	135	10.10	0715307	141	154.00
0658610	274	48.20	0710105	135	10.10	0715903	141	11.60
0658611	274	47.20	0710111	136	4.30	0715907	141	11.60
0658612	274	47.20	0710112	136	4.30	0715915	141	16.20



Ref. No.	Page	List price €	Ref. No.	Page	List price €	Ref. No.	Page	List price €
0715917	141	12.80	0726304	151	410.00	0741148	161	104.00
0715919	141	12.80	0726305	151	504.00	0741149	161	104.00
0715921	141	17.90	0726306	151	327.00	0741163	161	210.00
0715922	141	13.50	0726310	151	665.00	0741164	161	210.00
0715923	141	13.40	0726311	151	681.00	0741165	161	210.00
0715925	141	16.40	0726312	151	1,081.00	0741166	161	210.00
0715926	141	12.80	0726313	151	779.00	0741167	161	210.00
0715929	141	12.80	0726500	151	670.00	0741168	161	210.00
0715940	142	2.40	0726501	151	956.00	0741170	159	164.00
0715950	142	24.30	0726502	151	1,486.00	0741172	161	196.00
0715955	142	15.40	0726510	151	1,018.00	0741174	161	160.00
0716101	143	134.00	0726511	151	971.00	0741176	160	110.00
0716102	143	196.00	0726512	151	1,818.00	0741178	160	110.00
0716105	143	176.00	0726513	151	1,122.00	0741179	160	110.00
0716111	143	259.00	0728105	152	379.00	0741180	160	110.00
0716192	143	57.00	0728106	152	369.00	0741182	160	183.00
0716194	143	70.00	0728107	152	421.00	0741184	163	623.00
0716196	143	90.00	0728108	152	587.00	0750101	165	134.00
0718101	144	48.90	0728109	152	847.00	0750102	165	179.00
0718104	144	102.00	0728110	152	2,000.00	0750111	165	57.00
0718105	144	115.00	0728201	152	966.00	0750112	165	105.00
0718106	144	175.00	0728202	152	691.00	0750121	165	82.00
0718108	144	150.00	0728203	152	644.00	0750122	165	92.00
0718109	144	172.00	0728204	152	447.00	0750601	165	24.10
0718110	144	192.00	0728205	152	452.00	0751103	166	113.00
0718112	144	97.00	0728206	152	431.00	0751104	166	132.00
0718113	144	111.00	0728207	152	504.00	0752101	167	138.00
0718115	144	115.00	0728208	152	655.00	0752103	167	177.00
0720102	145	153.00	0728209	152	868.00	0753110	164	23.90
0720103	145	218.00	0728210	152	2,047.00	0753120	164	59.00
0721100	146	491.00	0728910	152	1,195.00	0754101	166	95.00
0721101	146	491.00	0728915	152	1,184.00	0756101	167	57.00
0721120	146	509.00	0728920	152	1,714.00	0763100	170	268.00
0721121	146	509.00	0735101	153	392.00	0770102	168	169.00
0721122	146	509.00	0735102	153	353.00	0770103	168	214.00
0721123	146	509.00	0735103	153	410.00	0770201	168	216.00
0721124	146	526.00	0735902	153	179.00	0770205	168	335.00
0721125	146	526.00	0736101	153	904.00	0772024	169	728.00
0721126	146	526.00	0736102	153	975.00	0780001	173	361.00
0721127	146	526.00	0736103	153	1,044.00	0780002	173	400.00
0721140	147	139.00	0737101	154	880.00	0780003	173	623.00
0721141	147	491.00	0737121	154	87.00	0780021	172	84.00
0721142	147	491.00	0737122	154	87.00	0780023	172	128.00
0721143	147	491.00	0737123	154	87.00	0780032	173	155.00
0721144	147	491.00	0737124	154	87.00	0780033	173	222.00
0721145	147	491.00	0739102	155	1,708.00	0780042	173	185.00
0721148	147	748.00	0739121	157	87.00	0780043	173	250.00
0721149	147	748.00	0739122	157	99.00	0780072	172	101.00
0721731	148	526.00	0739123	157	90.00	0780073	172	177.00
0721732	148	526.00	0739124	156	103.00	0780074	172	203.00
0721733	148	526.00	0739125	156	107.00	0780091	173	365.00
0721734	148	526.00	0739126	156	61.00	0780092	173	410.00
0721738	148	670.00	0739127	156	98.00	0780093	173	844.00
0721739	148	670.00	0739128	156	61.00	0780094	173	872.00
0721740	148	925.00	0739129	156	118.00	0780101	171	581.00
0721741	149	526.00	0739130	156	99.00	0780102	171	737.00
0721745	149	670.00	0739131	156	107.00	0780104	171	664.00
0721746	149	670.00	0739132	156	142.00	0780105	171	756.00
0721747	149	925.00	0739164	157	37.00	0780107	171	1,904.00
0721785	149	140.00	0739165	157	45.70	0780108	171	2,123.00
0721786	149	140.00	0739170	157	183.00	0780141	172	2,031.00
0724101	136	46.00	0741101	159	1,787.00	0780142	172	2,298.00
0724504	150	895.00	0741112	159	249.00	0782160	174	678.00
0724508	150	870.00	0741114	159	264.00	0782181	174	216.00
0724522	150	1,215.00	0741116	159	403.00	0782191	174	1,125.00
0724530	150	2,675.00	0741122	162	259.00	0783012	174	3,402.00
0724904	150	750.00	0741124	162	311.00	0783070	174	284.00
0724908	150	775.00	0741132	162	84.00	0784108	175	2,976.00
0724922	150	895.00	0741134	163	146.00	0785108	169	613.00
0724930	150	1,180.00	0741136	162	241.00	0785109	169	1,502.00
0726122	151	143.00	0741140	161	184.00	0785110	169	1,727.00
0726123	151	131.00	0741141	161	104.00	0788104	176	1,085.00
0726124	151	124.00	0741142	161	104.00	0788180	176	220.00
0726130	151	227.00	0741143	161	104.00	0788904	177	864.00
0726300	151	292.00	0741144	161	104.00	0788980	177	70.00
0726301	151	293.00	0741145	161	104.00	0788990	177	313.00
0726302	151	930.00	0741146	161	104.00	0800501	86	18.10
0726303	151	660.00	0741147	161	104.00	0800502	86	22.00



Ref. No.	Page	List price €	Ref. No.	Page	List price €	Ref. No.	Page	List price €
0800503	86	25.20	0822302	99	138.00	0870949	103	182.00
0800504	86	29.80	0822303	99	254.00	0870951	103	182.00
0800513	86	106.00	0822304	99	416.00	0870953	103	207.00
0806501	87	32.70	0824302	99	174.00	0870955	103	285.00
0806502	87	35.80	0824303	99	176.00	0882300	119	263.00
0806503	87	39.00	0849501	98	707.00	0882301	119	286.00
0806504	87	42.10	0849502	98	841.00	0882303	119	314.00
0806513	87	154.00	0850511	98	559.00	0882304	119	368.00
0806521	88	44.80	0850512	98	620.00	0882306	119	592.00
0806522	88	71.00	0850514	98	659.00	0884501	107	794.00
0806523	88	87.00	0850516	98	704.00	0885501	107	176.00
0806524	88	101.00	0850518	98	737.00	0885502	107	195.00
0806525	88	137.00	0854301	100	247.00	0885503	107	204.00
0806526	88	154.00	0854302	100	299.00	0885504	107	245.00
0806527	88	171.00	0854303	100	321.00	0885505	107	311.00
0806528	88	188.00	0854304	100	348.00	0885506	107	359.00
0806540	88	264.00	0855301	100	178.00	0885507	107	457.00
0806542	88	581.00	0855302	100	218.00	0885508	107	518.00
0807101	86	54.00	0855303	100	247.00	0885503	119	23.40
0810501	89	248.00	0855304	100	261.00	0886505	119	27.00
0810502	89	262.00	0864321	105	317.00	0886507	119	23.40
0810503	89	275.00	0864322	105	380.00	0886513	119	41.60
0810504	89	292.00	0864323	105	412.00	0888101	108	49.00
0815510	89	261.00	0864324	105	447.00	0888501	108	154.00
0815514	89	275.00	0864325	105	483.00	0888502	108	154.00
0815518	89	344.00	0864326	105	517.00	0888503	108	154.00
0815530	89	296.00	0864327	105	556.00	0888504	108	160.00
0815534	89	437.00	0864328	105	594.00	0888505	108	166.00
0815540	89	483.00	0870301	102	295.00	0888506	108	185.00
0816501	90	312.00	0870302	102	308.00	0888507	108	190.00
0816502	90	352.00	0870303	102	331.00	0888508	108	197.00
0816503	90	406.00	0870304	102	362.00	0888509	108	204.00
0816504	90	464.00	0870305	102	396.00	0888510	108	210.00
0816505	90	528.00	0870306	102	431.00	0888511	108	216.00
0816506	90	596.00	0870307	102	614.00	0888512	108	224.00
0816507	90	842.00	0870309	102	671.00	0888513	108	232.00
0816508	90	889.00	0870311	102	738.00	0888514	108	241.00
0816509	90	944.00	0870801	104	70.00	0888515	108	247.00
0816510	90	1,013.00	0870802	104	71.00	0888516	108	257.00
0816511	90	1,093.00	0870803	104	72.00	0888517	108	263.00
0816512	90	1,170.00	0870804	104	73.00	0888518	108	273.00
0817512	91	1,005.00	0870805	104	74.00	0888519	108	281.00
0817514	91	1,045.00	0870807	104	82.00	0888520	108	288.00
0817516	91	1,170.00	0870809	104	92.00	0888521	108	295.00
0817518	91	1,327.00	0870811	104	102.00	0890511	106	66.00
0817520	91	1,485.00	0870821	104	70.00	0892332	109	71.00
0817522	91	1,647.00	0870822	104	71.00	0892333	109	72.00
0817524	91	1,813.00	0870823	104	72.00	0892334	109	80.00
0817526	91	2,006.00	0870824	104	77.00	0892336	109	98.00
0817528	91	2,209.00	0870825	104	78.00	0892339	109	130.00
0817530	91	2,417.00	0870827	104	89.00	0892340	109	182.00
0817532	91	2,645.00	0870829	104	103.00	0892501	109	376.00
0817534	91	2,931.00	0870831	104	117.00	0892502	109	461.00
0817536	91	3,128.00	0870841	104	153.00	0892503	109	568.00
0817538	91	4,898.00	0870842	104	157.00	0892504	109	716.00
0817540	91	5,198.00	0870843	104	161.00	0892505	109	909.00
0817542	91	5,593.00	0870844	104	168.00	0894504	110	224.00
0817544	91	5,925.00	0870845	104	182.00	0894510	110	595.00
0817546	91	6,295.00	0870847	104	217.00	0894514	110	802.00
0817910	91	157.00	0870849	104	265.00	0894518	110	1,036.00
0819501	92	177.00	0870851	104	324.00	0894522	110	1,276.00
0819502	92	197.00	0870901	103	111.00	0894526	110	1,313.00
0819503	92	218.00	0870903	103	96.00	0894530	110	1,540.00
0819505	92	249.00	0870905	103	96.00	0894534	110	1,582.00
0819510	92	239.00	0870907	103	96.00	0894538	110	2,761.00
0819511	92	301.00	0870909	103	96.00	0894542	110	3,601.00
0819512	92	343.00	0870911	103	111.00	0894546	110	4,470.00
0819513	92	395.00	0870921	103	121.00	0894550	110	5,311.00
0819514	92	488.00	0870923	103	105.00	0894554	110	6,152.00
0819515	92	561.00	0870925	103	105.00	0894804	110	160.00
0819516	92	644.00	0870927	103	105.00	0894806	110	182.00
0819517	92	727.00	0870929	103	105.00	0894810	110	197.00
0819519	92	1,351.00	0870931	103	105.00	0894820	110	217.00
0819521	92	1,455.00	0870933	103	121.00	0894834	110	247.00
0819523	92	1,714.00	0870941	103	285.00	0894854	110	811.00
0819525	92	1,969.00	0870943	103	207.00	0894872	110	842.00
0819527	92	2,265.00	0870945	103	182.00	0898101	101	10.90
0822301	99	91.00	0870947	103	182.00	0898102	101	18.30



Ref. No.	Page	List price €	Ref. No.	Page	List price €	Ref. No.	Page	List price €
0898103	101	21.70	0940823	111	1,195.00	1330534	46	1,152.00
0898104	101	24.80	0940829	111	1,360.00	1331522	46	443.00
0898105	101	28.70	0940833	111	1,530.00	1331528	46	654.00
0898106	101	40.60	0940839	111	1,750.00	1331532	46	1,007.00
0898107	101	45.40	0940891	111	129.00	1331534	46	1,157.00
0898108	101	50.00	0940892	111	145.00	1334522	47	354.00
0898109	101	55.00	0940893	111	179.00	1334528	47	497.00
0898110	101	60.00	0940894	111	219.00	1334532	47	869.00
0898111	101	64.00	0940895	111	295.00	1334534	47	1,028.00
0898112	101	80.00	0940896	111	895.00	1335522	47	405.00
0898113	101	86.00	0996701	280	74.00	1335528	47	572.00
0898114	101	92.00	0996705	280	141.00	1335532	47	934.00
0898115	101	98.00	0997770	281	241.00	1335534	47	1,073.00
0898116	101	105.00	0997772	281	241.00	1338522	53	456.00
0898117	101	111.00	0997774	281	294.00	1340522	48	414.00
0898118	101	117.00	0997778	281	791.00	1340528	48	789.00
0898119	101	123.00	1271451	75	85.00	1340532	48	1,065.00
0898120	101	130.00	1271452	75	99.00	1340534	48	1,310.00
0898121	101	136.00	1271455	75	57.00	1341522	48	468.00
0898122	101	143.00	1276591	76	18.00	1341528	48	843.00
0898123	101	150.00	1278912	81	109.00	1341532	48	1,118.00
0898124	101	157.00	1278916	81	109.00	1341534	48	1,363.00
0898125	101	164.00	1278920	81	109.00	1342522	49	380.00
0898126	101	170.00	1278923	81	27.00	1342528	49	702.00
0898127	101	177.00	1278924	81	27.00	1342532	49	971.00
0898128	101	184.00	1278930	81	396.00	1342534	49	1,208.00
0898129	101	191.00	1278936	81	27.00	1343522	49	434.00
0898130	101	198.00	1278938	81	27.00	1343528	49	756.00
0898131	101	205.00	1278940	81	27.00	1343532	49	1,025.00
0898132	101	212.00	1278942	81	27.00	1343534	49	1,261.00
0898133	101	217.00	1278944	81	27.00	1348722	56	583.00
0898134	101	224.00	1278946	81	27.00	1348728	56	747.00
0898135	101	232.00	1278948	81	27.00	1351522	52	532.00
0898136	101	239.00	1278950	81	27.00	1351528	52	688.00
0898137	101	245.00	1278952	81	27.00	1351622	52	567.00
0898138	101	252.00	1278954	81	27.00	1351628	52	752.00
0898139	101	260.00	1278956	81	27.00	1351920	55	479.00
0898140	101	266.00	1278958	81	27.00	1352516	61	372.00
0898142	101	278.00	1278960	81	27.00	1352517	61	419.00
0898146	101	305.00	1278962	81	27.00	1352518	61	768.00
0898150	101	335.00	1279780	78	109.00	1352520	61	864.00
0898154	101	361.00	1279781	78	109.00	1352522	61	901.00
0898158	101	389.00	1279782	78	109.00	1353522	59	471.00
0898162	101	623.00	1279783	78	109.00	1354520	55	566.00
0898166	101	654.00	1279784	78	109.00	1360716	69	316.00
0898170	101	684.00	1279785	78	109.00	1360718	69	358.00
0898174	101	714.00	1320416	25	109.00	1360722	69	402.00
0898178	101	743.00	1320417	25	109.00	1360728	69	462.00
0912501	93	78.00	1320516	25	142.00	1360734	69	1,315.00
0912502	93	88.00	1320517	25	142.00	1360738	69	2,006.00
0912503	93	101.00	1320518	25	384.00	1360740	69	2,381.00
0912504	93	115.00	1320519	25	179.00	1362722	70	412.00
0912505	93	127.00	1320522	25	230.00	1362728	70	479.00
0912506	93	139.00	1322516	27	203.00	1364722	71	390.00
0912507	93	150.00	1326416	26	158.00	1364728	71	434.00
0912508	93	161.00	1326417	26	158.00	1366718	72	405.00
0912521	93	417.00	1326418	26	219.00	1366722	72	489.00
0932701	97	473.00	1326422	26	277.00	1366728	72	616.00
0932702	97	551.00	1326516	27	158.00	1368722	73	412.00
0932703	97	623.00	1326517	27	158.00	1368728	73	469.00
0932704	97	675.00	1326518	27	231.00	1371416	75	372.00
0932705	97	727.00	1326904	34	550.00	1371418	75	409.00
0932706	97	779.00	1326906	35	545.00	1371422	75	456.00
0932707	97	831.00	1326908	34	469.00	1371428	75	525.00
0932708	97	935.00	1326910	35	539.00	1375502	79	239.00
0932731	97	603.00	1326912	31	307.00	1376514	76	496.00
0932732	97	623.00	1326914	26	329.00	1378505	80	756.00
0932733	97	675.00	1326916	32	380.00	1378508	80	814.00
0932734	97	727.00	1326918	30	483.00	1379722	77	636.00
0933701	105	779.00	1326920	31	523.00	1379728	77	877.00
0933702	105	857.00	1326922	32	429.00	1722502	123	138.00
0933703	105	909.00	1326924	33	425.00	1723502	123	174.00
0933704	105	961.00	1326928	33	457.00	1724502	123	284.00
0933705	105	1,013.00	1326930	30	627.00	1726502	123	331.00
0933706	105	1,065.00	1326932	29	352.00	1726506	123	365.00
0933707	105	1,117.00	1330522	46	384.00	1726510	123	642.00
0933708	105	1,195.00	1330528	46	583.00	1726514	123	795.00
0940816	111	835.00	1330532	46	952.00	1728502	123	277.00



Ref. No.	Page	List price €	Ref. No.	Page	List price €	Ref. No.	Page	List price €
1728506	123	353.00	1923528	114	1,285.00	4320834	284	245.00
1728510	123	576.00	1923530	114	1,315.00	4320838	284	245.00
1728514	123	737.00	1923532	114	1,345.00	4320842	284	245.00
1730502	122	367.00	1923534	114	1,395.00	4320846	284	245.00
1730506	122	414.00	1923536	114	1,695.00	4320850	284	291.00
1732502	122	310.00	1923538	114	1,895.00	4320854	284	291.00
1732506	122	391.00	1923540	114	2,040.00	4320858	284	347.00
1734502	122	381.00	1923542	114	2,215.00	4320862	284	347.00
1734506	122	437.00	1923574	115	1,700.00	4320866	284	347.00
1734522	126	494.00	1923576	115	1,500.00	4329010	284	7.00
1739910	123	38.40	1923578	115	2,200.00	4329026	284	16.00
1739920	122	14.30	1923580	115	2,700.00	4329046	284	32.00
1866210	96	169.00	1924100	117	480.00	4340210	284	15.00
1866410	94	199.00	1924200	117	480.00	4340214	284	16.50
1866413	94	259.00	1924300	117	560.00	4340218	284	24.30
1866417	94	329.00	1924510	116	785.00	4340222	284	41.60
1866420	94	375.00	1924512	116	785.00	4340226	284	49.60
1920574	113	1,081.00	1924514	116	795.00	4340230	284	74.00
1920576	113	758.00	1924516	116	805.00	4342410	284	11.50
1920578	113	1,870.00	1924518	116	835.00	4342610	284	26.40
1920580	113	2,234.00	1924520	116	835.00	4350210	284	30.10
1920910	113 / 118	88.00	1924522	116	865.00	4350218	284	49.20
1920914	113 / 118	94.00	1924524	116	910.00	4350226	284	74.00
1920920	113 / 118	99.00	1924526	116	915.00	4350232	284	96.00
1920924	113 / 118	119.00	1924528	116	995.00	4350238	284	134.00
1921510	112	384.00	1924530	116	1,035.00	4351610	285	25.10
1921512	112	384.00	1924532	116	1,070.00	4351618	285	59.00
1921514	112	384.00	1924534	116	1,120.00	4351628	285	87.00
1921516	112	384.00	1924536	116	1,380.00	4351638	285	111.00
1921518	112	405.00	1924538	116	1,590.00	4352412	285	14.30
1921520	112	416.00	1924540	116	1,700.00	4352418	285	22.70
1921522	112	421.00	1924542	116	1,900.00	4352422	285	43.00
1921524	112	473.00	1924574	117	1,400.00	4353410	285	52.00
1921526	112	473.00	1924576	117	1,200.00	4353510	285	73.00
1921528	112	545.00	1924578	117	2,000.00	4357010	285	10.80
1921530	112	561.00	1924580	117	2,600.00	4357020	285	31.80
1921532	112	577.00	1997501	278	48.00	4357610	285	11.00
1921534	112	592.00	1998501	278	61.00	4357620	285	18.70
1921536	112	831.00	1998710	278	231.00	4358410	285	16.50
1921538	112	982.00	1998712	278	58.00	4358420	285	29.10
1921540	112	1,034.00	1998720	278	69.00	4358810	285	18.70
1921542	112	1,091.00	1998722	280	58.00	4359210	285	23.80
1922510	118	290.00	1998730	280	115.00	4359410	285	30.40
1922512	118	290.00	1998732	280	69.00	4360210	285	24.30
1922514	118	295.00	1998740	280	97.00	4360212	285	34.80
1922516	118	295.00	1998742	280	348.00	4360214	285	39.50
1922518	118	305.00	1998744	280	348.00	4360218	285	51.00
1922520	118	315.00	1998746	280	477.00	4360810	285	33.70
1922522	118	325.00	1998748	280	477.00	019650105	16	24.10
1922524	118	365.00	1998750	280	130.00	019650116	16	24.10
1922526	118	365.00	1998760	193	141.00	019650516	16	34.50
1922528	118	435.00	1998770	123	5.70	026552005	45	259.00
1922530	118	445.00	1998780	279	97.00	026652005	45	347.00
1922532	118	460.00	4310110	284	11.50	132641660	24	218.00
1922534	118	475.00	4310115	284	20.60	132641760	24	218.00
1922536	118	695.00	4310120	284	34.80	132641860	24	279.00
1922538	118	845.00	4310125	284	74.00	132642260	24	337.00
1922540	118	915.00	4310130	284	102.00	137141660	74	432.00
1922542	118	945.00	4310135	284	159.00	137141860	74	459.00
1923100	115	765.00	4320210	284	19.60	137142260	74	516.00
1923200	115	765.00	4320212	284	26.40	137142860	74	585.00
1923300	115	765.00	4320214	284	28.70	172650260	127	391.00
1923510	114	1,055.00	4320220	284	31.80	172650660	127	425.00
1923512	114	1,055.00	4320224	284	35.10	173450260	127	441.00
1923514	114	1,065.00	4320228	284	58.00	173450660	127	497.00
1923516	114	1,065.00	4320810	284	123.00	186641060	95	259.00
1923518	114	1,110.00	4320814	284	175.00	186641360	95	319.00
1923520	114	1,130.00	4320818	284	187.00	186641760	95	389.00
1923522	114	1,140.00	4320822	284	192.00	186642060	95	435.00
1923524	114	1,190.00	4320826	284	192.00	186642160	96	1,390.00
1923526	114	1,195.00	4320830	284	192.00			

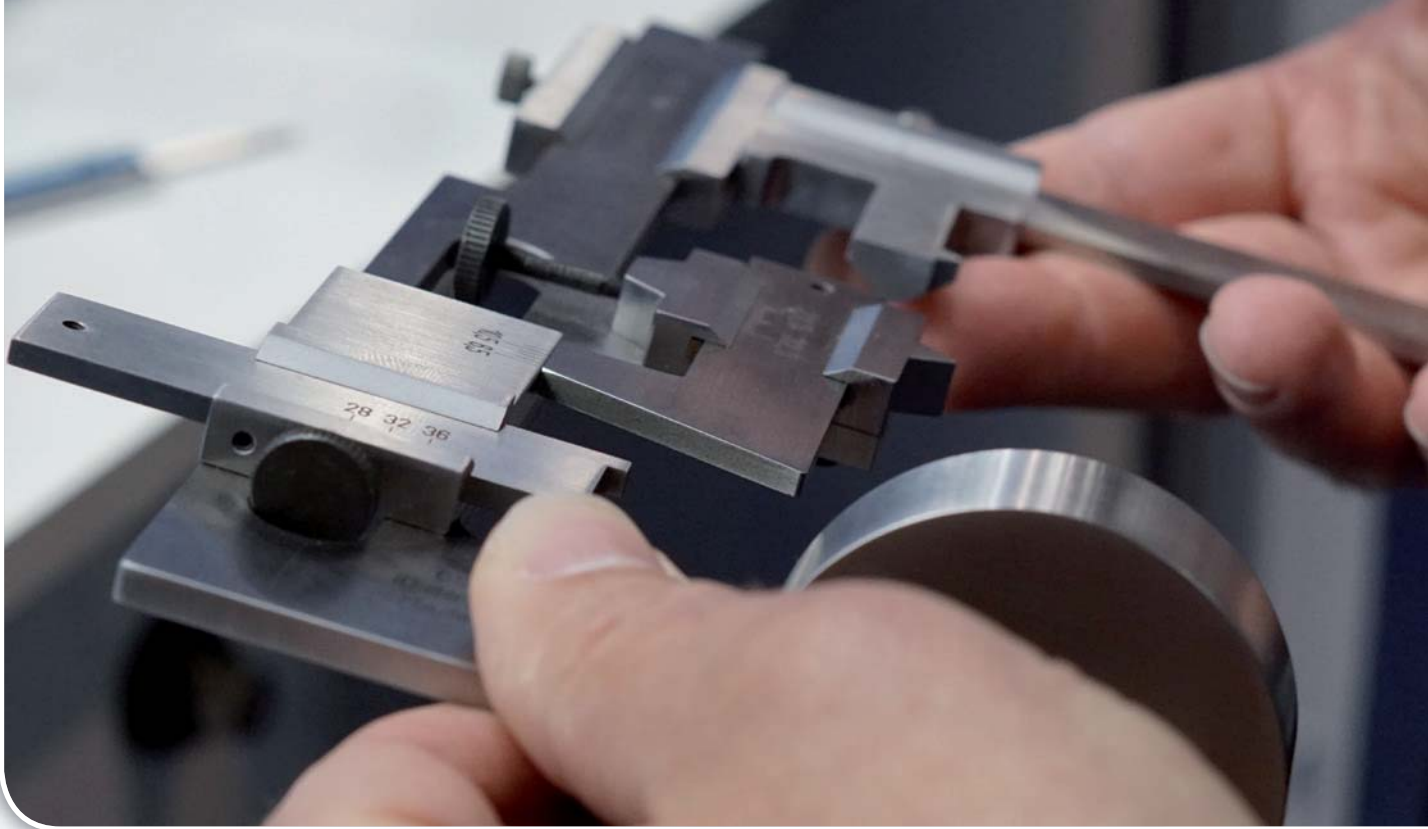

CUSTOM MADE PRODUCTS ACCORDING TO CUSTOMER SPECIFICATIONS

This statement is as true for our overall product range as it is for individual items

such as digital callipers, gauges and external micrometers. Whether universal or special, our options range from small, handy vernier digital pocket callipers to versatile, highly accurate comparators.

What sets all of our products apart, regardless of variant, is their utmost precision and a very special strength:

customisation according to your wishes.

We offer the same quality in all other areas of portable measurement technology,

including advice from experienced staff, problem solving, training, calibration... There's one thing you can completely rely on: anything displaying the HELIOS-PREISSER logo meets the highest standards. Guaranteed!



0 - 9	Seite
2/3 point internal micrometers, analogue	108 - 113
3 point internal measuring pistol, digital	116, 117
3 point internal micrometers, digital	114, 115
A	
Acute angle squares 45°	209
Adjustable squares	211
Adjustable V-blocks	235
Alpha square	210
Aluminium straight edges	221
Angle lever attachment	136
Angle normal 90°	231
B	
Base stand for inspection plates	230
Base stand for surface and inspection plates	231
Batteries for electronic devices	24, 93, 123
Beam compass	183, 184
Beam trammel	183, 184
Bench centres & accessories	171, 172
Bevel protractors	213-215
Blade micrometers	100
Box for data input	281
Brake disc inspection gauges	60
Brake drum vernier calipers	60
C	
Cabinets for measuring and inspection plates	231
Cable for data transmission	270, 271, 274
Calibration service	284, 285
Calipers for 3/5 point measurement	62
Calipers for external locking grooves, analogue & digital	59
Calipers for internal grooves, analogue & digital	61
Calipers with cross points, analogue & digital	45, 55
Calipers with gripper points analogue & digital	45, 55
Calipers with integrated Wireless	24
Calipers, analogue	14-22, 37-45, 58-64
Calipers, digital	25-35, 46-56, 59, 61
Carbide gauge block sets	264
Carpenters squares	210
Centre points	260
Centre squares	207
Ceramic gauge block sets	256
Chamfer gauge	63, 244
Combined internal / external calipers	185
Compact measuring stands	168
Concentricity measuring gauge with disc supports	167
Connecting cables for electronic instruments	270, 271, 274
Contraction vernier calipers	57, 58
Convertor mm/inch	242
Crankpin levels	237
Crankshaft gauges	153
Cutting gauges	239, 240
D	
Data acquisition / data transmission	278-281
Data cables	270, 271, 274
DBP weld seam gauge	243
Depth attachment base for pocket calipers	26
Depth gauge, digital, with interchangeable inserts	75
Depth gauges with integrated wireless	74
Depth gauges, digital	69-80
Depth measuring base for indicators	143
Depth micrometers	119
Depthgauge, digital, for one-hand operation	80
Dial calipers	21
Dial comparator gauges »MICROTAST«	134
Dial depth gauges with a measuring base	143
Dial gauges, analogue	129-134
Dial gauges, shockproof	129-131
Dial gauges, shockproof, error free	133
Dial gauges, small	129
Dial gauges, water and oil proof	131
Dial gauges, with concentric mm-display	130, 131
Dial gauges, with extended measuring range	130

D	Seite
Dial gauges, with reverse action plunger	134
Dial micrometers	98
Dial test indicators and accessories	141
Dial thickness gauges	144, 145
Digital pocket calipers	24-35
Digital pocket calipers for specific measuring tasks	30-35
Digital pocket calipers IP67	26
Digital pocket calipers PRISMA	27
DIN thread conversion	241
Disc micrometer to measure gear tooth, analogue & digital	105
Disc micrometers	99
Dividers	181
Double V-blocks	232-234
Drill and steel wire hole gauges	246
Duo-Fix pocket vernier caliper	18
E	
Extension depth attachment base for depth gauges	73, 75
Extensions for dial gauges	136
Extensions measuring tool set for pocket calipers	28
External caliper gauges, analogue	146, 147
External caliper gauges, digital	148, 149
External calipers	178, 179
F	
Feeler gauge tapes	250
Feeler gauge tapes INOX	251
Feeler gauges	248, 249
Filetor ISO thread convertor	241
Flange squares	207
Flexible steel rules	220, 221
Frame levels	238
G	
Gauge block accessories sets	258
Gauge block holders	260
Gauge block inspection sets for micrometers and calipers	261
Gauge block maintenance set	260
Gauge blocks	255-257
Gear tooth calipers	64
H	
Height and scribing gauges	192
Height and scribing gauges, digital	193, 194
Holder for external micrometers	86
Holder for feeler gauge tapes	251
Holder for internal micrometers	108
I	
Indicators	122-128
Indicators with integrated wireless	127
Inspection plates	229, 230
Inspection points	258
Inspection set for micrometers and calipers	261
Inspection square set	206
Inspection squares, hardened	191
Integrated Wireless caliper	24
Integrated Wireless Indicators	127
Integrated Wireless micrometers	94-96
Interchangeable inserts for depth caliper	78
Interior circumference tapes	223
Internal caliper gauges, analogue	139, 140
Internal caliper gauges, digital	140, 141
Internal calipers	186, 187
Internal micrometer digital	111
Internal micrometers with extensions	190, 110
Internal micrometers with interchangeable extensions	190, 110
Internal micrometers with measuring jaws	107
Internal micrometers, cylindrical version	108
Internal precision bore gauges	145
i-Stick receiver for intergated wireless	279
K	
Knife edge jaws	259
Knife edge rule	227
Knife edge squares, hardened	205



L	Seite	S	Seite
Lapping and inspection plate	229	Set of 3 point internal micrometers, analogue	113
Length measuring instrument for external incisions	153	Set of 3 point internal micrometers, measuring pistol	117
Length measuring instrument for internal incisions	153	Set of external micrometers, analogue	86,87
Levels	237	Setting device for internal precision bore gauges	152
Lightweight workshop calipers, analogue & digital	44, 54	Setting standards for micrometers	101
Lug back	135	Shaft measuring instruments	176,177
M		Sine bars	232
Magnetic angle gauge	167	Sinus rules	232
Magnetic back	167	Small depth gauge, digital	79
Magnetic indicator stands with flexible arm	166	Snap gauges, adjustable	269
Magnetic measuring and clamping prism	235	Snap gauges, double jaw	269
Marking calipers	188	Software for data acquisition	278
Marking gauges	111	Spring dividers	182
Measuring and inspection plates	229	Squares with base	198-202
Measuring heads	118	Squares with hard and slim	203,204
Measuring inserts	137	Squares without base	198-202
Measuring stands	168	Stand for gaugeblock holders	260
Measuring tool set »Extensions«	28	Steel gauge block, sets	262
Measuring tool sets	28	Steel rules	225,226
Micrometers for thread flank measurement	102	Steel rules, flexible	220,221
Micrometers for tube wall measurement	99	Steel scale tapes for circumference and diameter	223
Micrometers with integrated wireless	95	Steel square	202
Micrometers with reduced measuring faces	98	Straight edges with bevelled edge	224
Micrometers, external, analogue	86	Surface roughness standards	252
Micrometers, external, digital	94-97	T	
Micrometers, external, with exchangeable anvils	91	Tapered hole gauges	245
Micrometers, external, with interchangeable inserts	92	Tapes for circumference and diameter	223
Milling tool caliper	62	Thread cutting gauges	239
Mitre squares	208	Thread flank inserts for external measurement	103
Mounting scales, digital	82	Thread flank setting standards for external measurement	104
Mounting straight edges	228	Thread plug gauges, individual and set	272
N		Thread ring gauges, individual and set	273-275
Nozzle gauges	245	Tolerator ISO tolerance convertor	241
P		Twist drill grinding gauges	242
Parallel blocks, set	236	Tyre profile depth gauge	20
Pattern maker angle	205	U	
Pin gauge holder	267	UHRTAST comparator gauge & accessories	159
Pin gauges, set	266	Universal bevel protractors, analogue & digital	216,217
Plane parallel jaws	259	Universal calipers, digital, Pocket-Talent	29
Plug gauges, individual and set	266	Universal comparator gauge & accessories	155
Pocket calipers	24-36	Universal grinding gauge	243
Pocket vernier caliper »Duo-Fix«	18	Universal indicator stands & magnetic base & accessories	164
Pocket vernier caliper »PRISMA«	18	Universal magnetic holder	166,167
Pocket vernier caliper, for lefthanded	19	Universal measuring support	165
Pocket vernier calipers	14-22	USB Keyboard interfaces	281
Pocket vernier calipers, parallax-free reading	18	V	
POCKET-TALENT	29	V-blocks	233, 234
Precision feeler gauge tapes	253	Vernier depth gauges	65-68
Precision reference sheets	254	W	
PRISMA calipers	18	Wall holders with feelergauge tape sets	250
Profile gauge	242	Welding gauges	243
Protractor level	238	Wire thickness micrometer	106
Protractors	213 - 215	Wireless data transmission	279
R		Wooden cases	83
Radius gauge	244	Workshop caliper, dial	44
Radius gauges, individual	244	Workshop calipers, analogue	37-43
Radiused measuring jaws	258	Workshop calipers, analogue, long measuring jaws	43
Ring gauges	271	Workshop calipers, digital	46-53
Roller supports for bench centre	173,177	Workshop calipers, digital, »PRISMA«	53
S		Workshop calipers, parallax-free reading	37
Screw pitch gauges	248	X	
Scribers	180	X type V-blocks (parallel)	233



HELIOS · PREISSER

